

# Specification for Approval

Customer: \_\_\_\_\_

Model Name: \_\_\_\_\_

Supplier Approval			Customer approval
R&D Designed	R&D Approved	QC Approved	
<i>Peter</i>	<i>Peng Jun</i>		



## Table of Contents

List	Description	Page No.
	Cover	1
	Revision Record	2
	Table of Contents	3
1	Scope	4
2	General Information	4
3	External Dimensions	5
4	Interface Description	6
5	Absolute Maximum Ratings	6
6	DC Characteristics	6
7	Timing Characteristics	7
8	Backlight Characteristics	11
9	Optical Characteristics	12
10	Reliability Test Conditions And Methods	14
11	Inspection Standard	15
12	Handling Precautions	19
13	Precaution for Use	20
14	Packing Method	20

## 1. Scope

This specification defines general provisions as well as inspection standards for TFT module supplied by AMSON electronics.

If the event of unforeseen problem or unspecified items may occur, naturally shall negotiate and agree to solution

## 2. General Information

ITEM	STANDARD VALUES	UNITS
LCD type	1.77”TFT	--
Dot arrangement	128(RGB)×160	dots
Color filter array	RGB vertical stripe	--
Display mode	TN / Transmission / Normally White	-
Eyes Viewing Direction	12 O'clock	--
Driver IC	ILI9163V	--
Module size	33.30(W)×42.94(H)×2.10(T)(Exclude FPC)	mm
Active area	28.03(W)×35.04(H)	mm
Interface	8 BIT MUC	--
Operating temperature	-20 ~ +70	°C
Storage temperature	-30 ~ +80	°C
Back Light	White LED*2	--



## 4. Interface Description

LCM PIN NO.	PIN NAME	DESCRIPTION
1	LEDK	LED backlight (Cathode).
2	LEDA	LED backlight (Anode).
3	VSS	Power ground
4	VCC	System power supply.
5-6	NC	NO connect
7	CS	Chip select input pin ("Low" enable).
8	RESET	Reset input pin, Active "L".
9	RS	Display data/command Selection Pin in MCU Interface
10	WR	Write Enable in MCU Parallel Interface
11	RD	Read Enable in 8080 MCU Parallel Interface
12-19	DB7-DB0	DATA BUS
20	VSS	Power ground

## 5. Absolute Maximum Ratings

Item	Symbol	Min.	Max.	Unit
Analog supply voltage	VCC	-0.3	4.8	V
Logic Supply Voltage	IOVCC	-0.3	4.6	V
Operating Temperature	TOP	-20	70	°C
Storage Temperature	TST	-30	80	°C
Storage Humidity	HD	20	90	%RH

## 6. DC Characteristics

Item	Symbol	Min.	Typ.	Max.	Unit	Remark
Analog Supply Voltage	VCC	2.5	2.78	3.3	V	-
Logic Supply Voltage	IOVCC	1.65	1.8	3.3	V	-
Input High Voltage	VIH	0.7VDD	-	VDD	V	-
Input Low Voltage	VIL	GND	-	0.3 VDD	V	-
Output High Voltage	VOH	0.8 VDD	-	VDD	V	-
Output Low Voltage	VOL	GND	-	0.2 VDD	V	-
I/O Leak Current	ILI	-1	-	1	uA	-

## 7. Timing Characteristics

### 7.1 Power on/off timing sequence

#### 7.1.1 Case 1 -RESX line is held high or Unstable by Host at Power -On

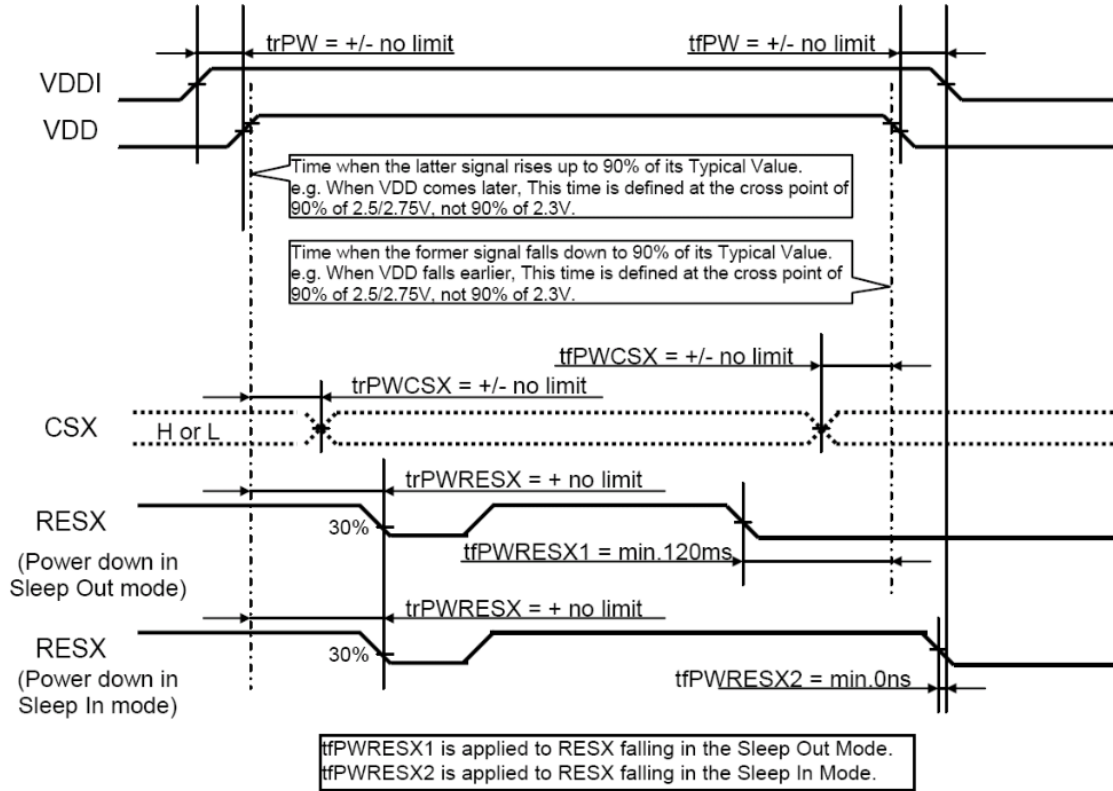

#### 7.1.2 Case 2 -RESX line is held Low by Host at Power On

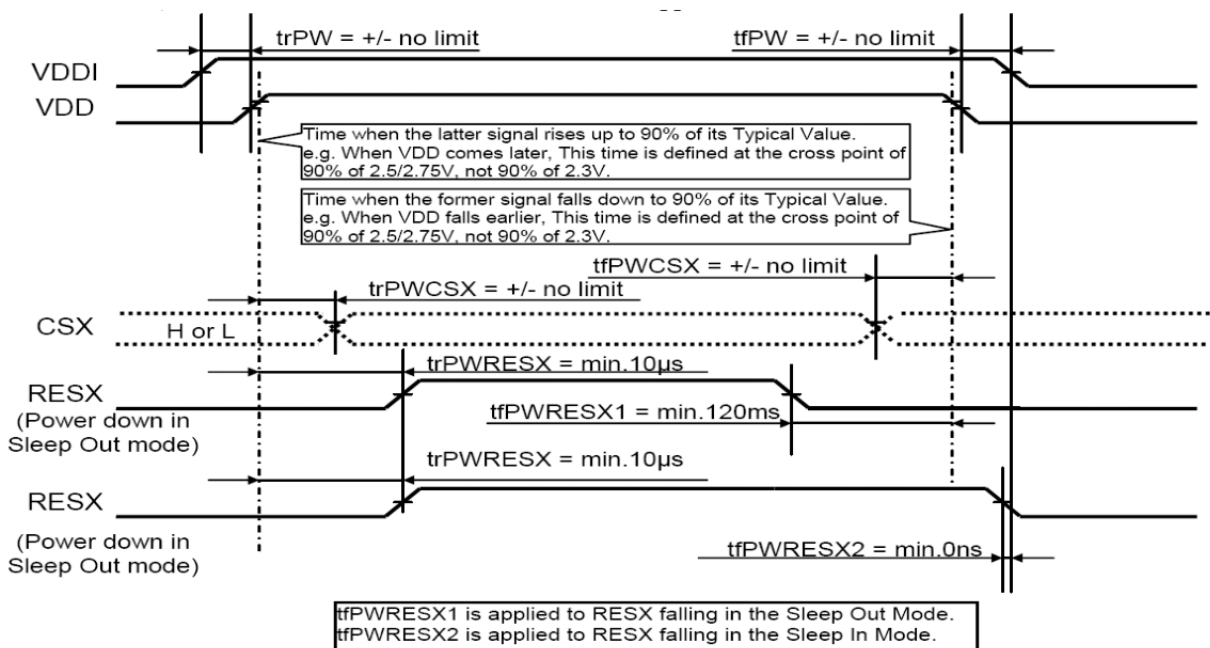

## 7.2 Reset Timing

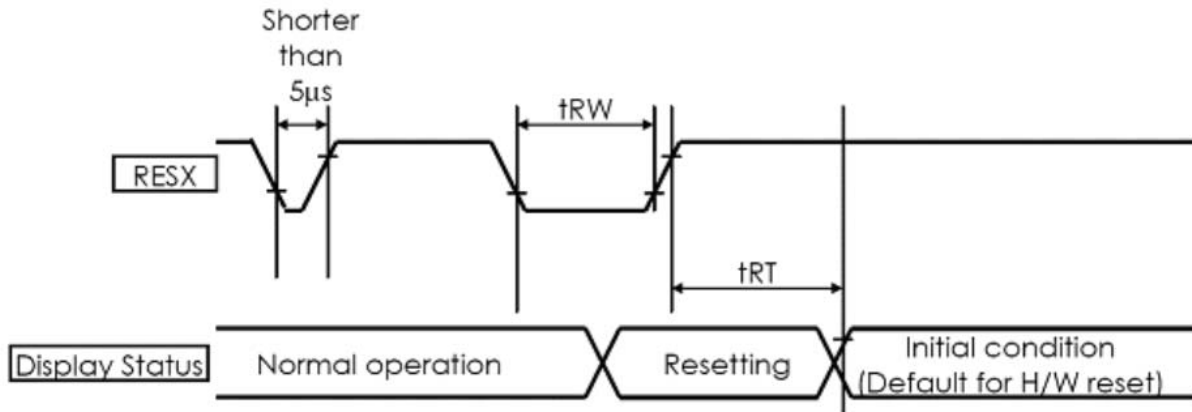

(VSS=0V, VDDI=1.65V to 1.95V, VPNL=2.6V to 2.9V, Ta = -30 to 70°C)

Symbol	Parameter	Related Pins	MIN	TYP	MAX	Note	Unit
tRESW	*1) Reset low pulse width	RESX	10	-	-	-	µs
tREST	*2) Reset complete width	-	-	-	5	When reset applied during Sleep in mode	ms
		-	-	-	120	When reset applied during Sleep out mode	ms





	trdh	Control pulse H duration(ID)	90		ns	data
	trdl	Control pulse L duration(ID)	45		ns	
RDX	trcfm	Read cycle (FM)	450		ns	When read from frame memory
	trdhfm	Control pulse H duration (FM)	90		ns	
	trdlfm	Control pulse L duration (FM)	355		ns	
D[17..0]	tdst	Data setup time	10		ns	For maximum CL = 30pF For minimum CL = 8pF
	tdht	Data hold time	10		ns	
	trat	Read access time (ID)		40	ns	
	tratfm	Read access time (FM)		340	ns	
	todh	Output disable time	20	80	ns	

## 8. Backlight Characteristics

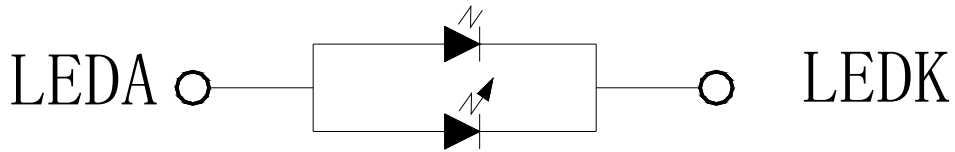

LED 指示灯

Item	Symbol	MIN	TYP	MAX	UNIT	Test Condition
Supply Voltage	Vf	3.0	3.2	3.6	V	If=40mA
Supply Current	If	-	40	-	mA	-
Luminous Intensity for LCM	-	130	180	-	cd/m <sup>2</sup>	If=40mA
Uniformity for LCM	-	80	-	-	%	If=40mA
Life Time	-	20000	-	-	Hr	If=40mA
Backlight Color	White					

## 9. Optical Characteristics

Item	Conditions	Min.	Typ.	Max.	Unit	Note	
Viewing Angle (CR>10)	Horizontal	$\theta_L$	40	45	-	degree	(1),(2),(6)
		$\theta_R$	40	45	-		
	Vertical	$\theta_T$	40	45	-		
		$\theta_B$	15	20	-		
Contrast Ratio	Center	200	300	-	-	(1),(3),(6)	
Response Time	Rising+Falling	-	30	60	ms	(1),(4),(6)	
CF Color Chromaticity (CIE1931)	Red x	Typ. -0.05	0.610	Typ. +0.05	-	(1), (6)	
	Red y		0.329		-		
	Green x		0.299		-		
	Green y		0.567		-		
	Blue x		0.143		-		
	Blue y		0.111		-		
	White x		0.308		-		
	White y		0.327		-		
transmittance	tr	-	6.9	-	%	(1),(6)	

Note (1) Measurement Setup: The LCD module should be stabilized at given temp. 25°C for 15 minutes to avoid abrupt temperature change during measuring. In order to stabilize the luminance, the measurement should be executed after lighting backlight for 15 minutes in a windless room.

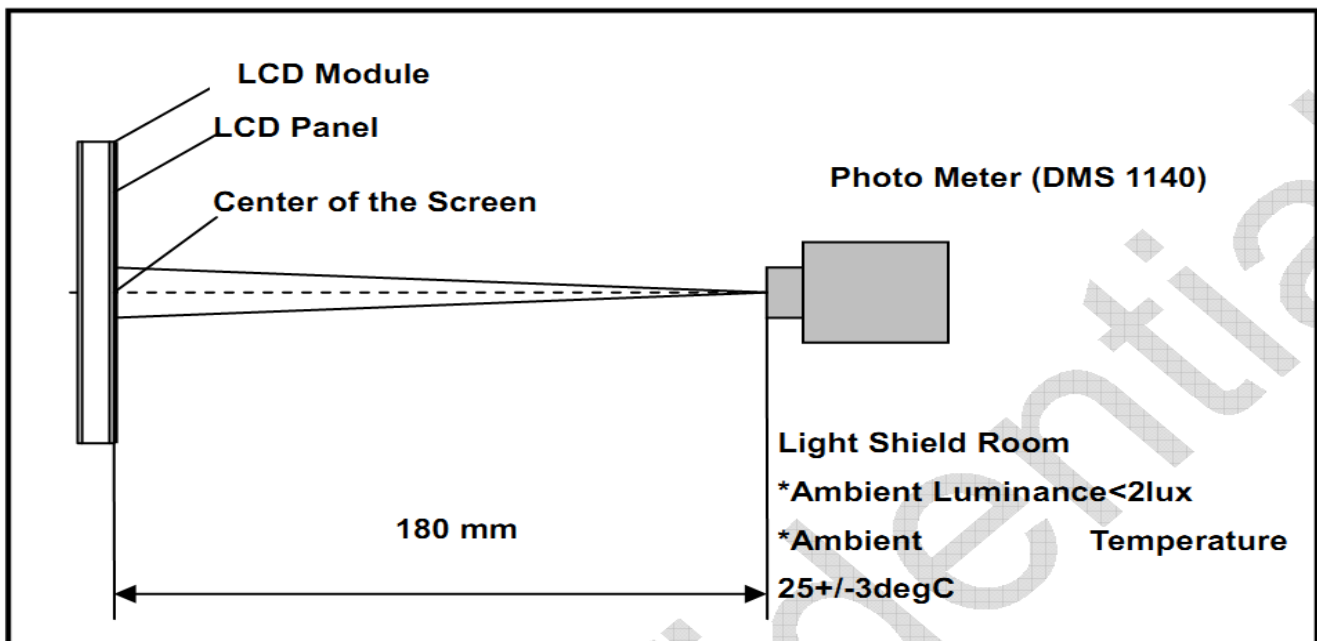

Note (2) Definition of Viewing Angle

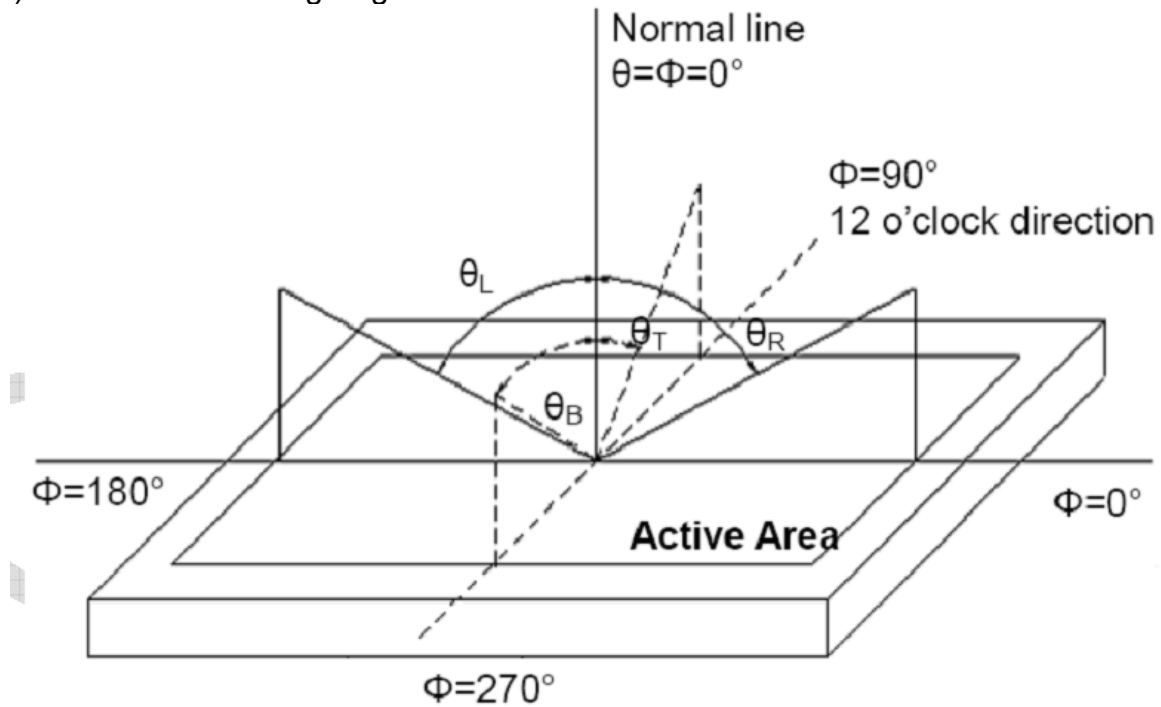

Note (3) Definition Of Contrast Ratio (CR)

The contrast ratio can be calculated by the following expression

$$\text{Contrast Ratio (CR)} = L_{63} / L_0$$

L63: Luminance of gray level 63, L0: Luminance of gray level 0

Note (4) Definition of response time

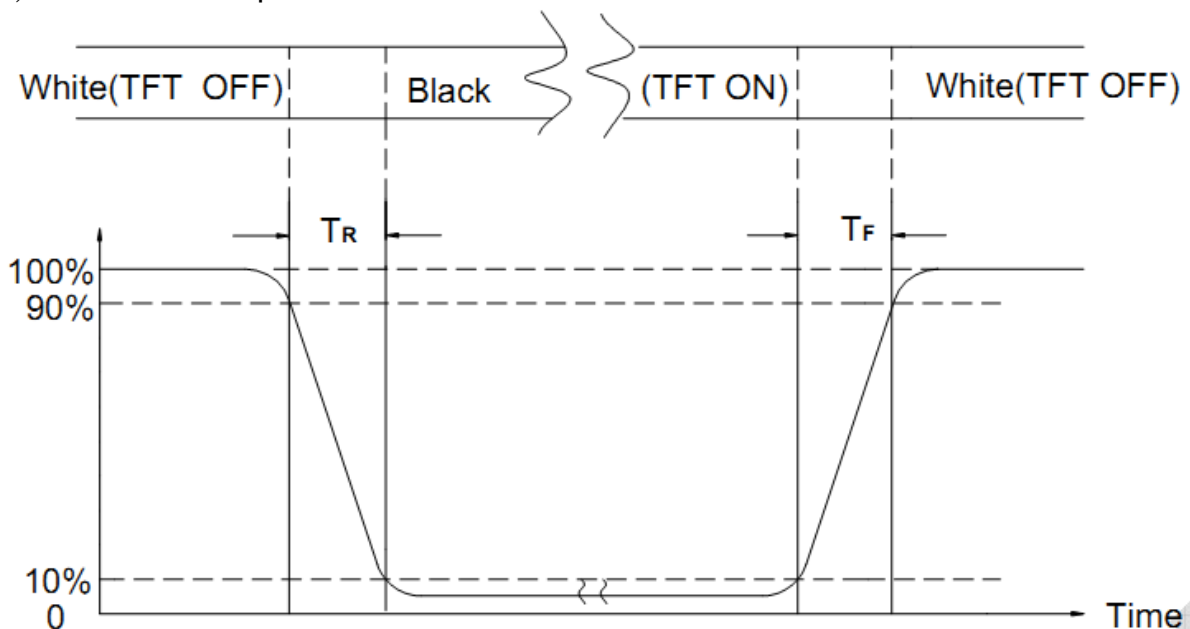

Note (5) Definition of Transmittance (Module is without signal input)

$$\text{Transmittance} = \text{Center Luminance of LCD} / \text{Center Luminance of Back Light} \times 100\%$$

Note (6) Definition of color chromaticity (CIE1931)

Color coordinates measured at the center point of LCD

## 10. Reliability Test Conditions and Methods

NO.	TEST ITEMS	TEST CONDITION	INSPECTION AFTER TEST
<input type="checkbox"/>	High Temperature Storage	80°C±2°C×96Hours	Inspection after 2~4hours storage at room temperature, the samples should be free from defects: 1, Air bubble in the LCD. 2, Seal leak. 3, Non-display. 4, Missing segments. 5, Glass crack. 6, Current IDD is twice higher than initial value. 7, The surface shall be free from damage. 8, The electric characteristic requirements shall be satisfied.
<input type="checkbox"/>	Low Temperature Storage	-30°C±2°C×96Hours	
<input type="checkbox"/>	High Temperature Operating	70°C±2°C×96Hours	
<input type="checkbox"/>	Low Temperature Operating	-20°C±2°C×96Hours	
<input type="checkbox"/>	Temperature Cycle(Storage)	-20°C ↔ 25°C ↔ 70°C (30min) ← (5min) → (30min) 1cycle Total 10cycle	
<input type="checkbox"/>	Damp Proof Test (Storage)	50°C±5°C×90%RH×96Hours	
<input type="checkbox"/>	Vibration Test	Frequency:10Hz~55Hz~10Hz Amplitude:1.5MM X,Y,Z direction for total 3hours (packing condition test will be tested by a carton)	
<input type="checkbox"/>	Drooping Test	Drop to the ground from 1M height one time every side of carton. (packing condition test will be tested by a carton)	
<input type="checkbox"/>	ESD Test	Voltage:±8KV,R:330Ω,C:150PF,Air Mode,10times	

### REMARK:

- 1, The Test samples should be applied to only one test item.
- 2, Sample side for each test item is 5~10pcs.
- 3,For Damp Proof Test, Pure water(Resistance > 10MΩ)should be used.
- 4,In case of malfunction defect caused by ESD damage, if it would be recovered to normal state after resetting, it would be judge as a good part.
- 5, EL evaluation should be accepted from reliability test with humidity and temperature: Some defects such as black spot/blemish can happen by natural chemical reaction with humidity and Fluorescence EL has.
- 6, Failure Judgment Criterion: Basic Specification Electrical Characteristic, Mechanical Characteristic, Optical Characteristic.

## 11. Inspection Standard

### 11.1 Incoming Inspection and Standard:

The below incoming inspection are applied to the TFT LCM Modules supplied by AMSON Optoelectronic Industry CO.,LTD. The customers should inspect the LCM within 14 days after receiving the goods. The result of inspection should be notified to the Seller in the writing copy promptly, if the customer do not send them within 14 days, the seller has the right to judge as acceptance of goods. The inspection lot size is treated as the quantity per shipment and per model. The sampling plan shall be inspected under MIL-STD015E in Level II by single sampling. The acceptable quality level (AQL) are categorized as below grades:

CRITICAL= 0.65%, MAJOR= 0.65%, MINOR= 1.5%

### 11.2 Inspection condition and Warranty policy:

The delivered LCM should be stored properly, ideally under climate-controlled environment at 25 (±5) degree Celsius as well as 60% (±10) Relative Humidity. The LCM shall be inspected in the viewing angle of 45 degree from the four major angles (U/D/L/R) under the single fluorescent lamp of 20W (equal to 300 to 500 lux). For warranty, AMSON Optoelectronic Industry CO.,LTD. will provide 12 months of warranty period as standard, and provide the new replacement for the defective products which belong to the Seller's responsibility verified by the quality department.

### 11.3 Inspection Criteria:

#### 11.3.1 Critical defect (重度缺失)

Item No.	Inspection content	Judgement
11.3.1.1	Functional defects	No display, abnormal display, short circuit, missing line, off-contrast and chromaticity, Touch Panel non-function
11.3.1.2	Model mixed	Other model mixed

#### 11.3.2 Major defect: (主要缺失)

Item No.	Inspection content	Judgement
11.3.2.1	Product indication	Missing model no. and wrong model no. is indicated on the LCM.
11.3.2.2	Glass cracking	The LCD and touch panel glass crack or breakage
11.3.2.3	Missing component	The function component missing such as connector, cable, etc.

### 11.3.3 Minor defect (LCD) : (次要缺失)

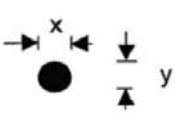
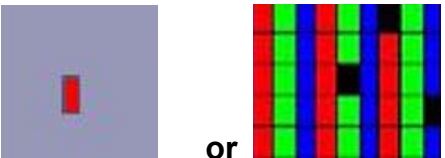
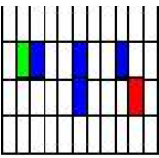
Item No.	Inspection content	Judgement												
11.3.3.1	Black/White spot Foreign particles Dust in the cell	$\phi = (x+y) / 2$  <table border="1"> <thead> <tr> <th>Diameter (mm)</th> <th>Acceptable Q'ty</th> </tr> </thead> <tbody> <tr> <td><math>\Phi \leq 0.1</math></td> <td>Ignore</td> </tr> <tr> <td><math>0.1 &lt; \Phi \leq 0.25</math></td> <td>3 (Distance&gt;5mm)</td> </tr> <tr> <td><math>0.25 &lt; \Phi</math></td> <td>Not allowed</td> </tr> </tbody> </table>	Diameter (mm)	Acceptable Q'ty	$\Phi \leq 0.1$	Ignore	$0.1 < \Phi \leq 0.25$	3 (Distance>5mm)	$0.25 < \Phi$	Not allowed				
Diameter (mm)	Acceptable Q'ty													
$\Phi \leq 0.1$	Ignore													
$0.1 < \Phi \leq 0.25$	3 (Distance>5mm)													
$0.25 < \Phi$	Not allowed													
11.3.3.2	Linear defect Black/white line Black/white scratch	<table border="1"> <thead> <tr> <th>Length(mm)</th> <th>Width (mm)</th> <th>Acceptable Q'ty</th> </tr> </thead> <tbody> <tr> <td></td> <td><math>W \leq 0.03</math></td> <td>Ignore</td> </tr> <tr> <td><math>L \leq 5.0</math></td> <td><math>0.03 &lt; W \leq 0.07</math></td> <td>3</td> </tr> <tr> <td></td> <td><math>0.07 &lt; W</math></td> <td>Follow 11.3.3.1</td> </tr> </tbody> </table>	Length(mm)	Width (mm)	Acceptable Q'ty		$W \leq 0.03$	Ignore	$L \leq 5.0$	$0.03 < W \leq 0.07$	3		$0.07 < W$	Follow 11.3.3.1
Length(mm)	Width (mm)	Acceptable Q'ty												
	$W \leq 0.03$	Ignore												
$L \leq 5.0$	$0.03 < W \leq 0.07$	3												
	$0.07 < W$	Follow 11.3.3.1												
11.3.3.3	Polarizer Bubbles Dent on polarizer	<table border="1"> <thead> <tr> <th>Diameter (mm)</th> <th>Acceptable Q'ty</th> </tr> </thead> <tbody> <tr> <td><math>\Phi \leq 0.2</math></td> <td>Ignore</td> </tr> <tr> <td><math>0.2 &lt; \Phi \leq 0.5</math></td> <td>2 (Distance&gt;5mm)</td> </tr> <tr> <td><math>0.5 &lt; \Phi</math></td> <td>Not allowed</td> </tr> </tbody> </table>	Diameter (mm)	Acceptable Q'ty	$\Phi \leq 0.2$	Ignore	$0.2 < \Phi \leq 0.5$	2 (Distance>5mm)	$0.5 < \Phi$	Not allowed				
Diameter (mm)	Acceptable Q'ty													
$\Phi \leq 0.2$	Ignore													
$0.2 < \Phi \leq 0.5$	2 (Distance>5mm)													
$0.5 < \Phi$	Not allowed													
11.3.3.4	Electrical defect Dot	<p><b>Bright dot and Dark dot definition:</b></p>  <p>or</p>  <p>(Two adjacent dot)</p> <p><b>Inspection pattern: black, white, red, green, and blue screen.</b></p> <table border="1"> <thead> <tr> <th>Items</th> <th>Acceptable Q'ty</th> </tr> </thead> <tbody> <tr> <td>Bright dot</td> <td><math>N \leq 4</math> (Distance &gt;5mm)</td> </tr> <tr> <td>Dark dot</td> <td><math>N \leq 4</math> (Distance &gt;5mm)</td> </tr> </tbody> </table>	Items	Acceptable Q'ty	Bright dot	$N \leq 4$ (Distance >5mm)	Dark dot	$N \leq 4$ (Distance >5mm)						
Items	Acceptable Q'ty													
Bright dot	$N \leq 4$ (Distance >5mm)													
Dark dot	$N \leq 4$ (Distance >5mm)													

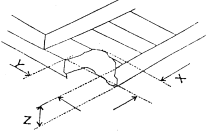
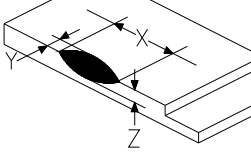

<p>11.3.3.5</p>	<p><b>Glass Defect- Corner chipping</b></p>	 <table border="1" data-bbox="702 392 1412 667"> <thead> <tr> <th>Size(mm)</th> <th>Judgement</th> </tr> </thead> <tbody> <tr> <td> <math>X \leq 3\text{mm}, Y \leq S,</math>  <math>Z \leq T</math>            (S= ITO length,            T=Single glass            thickness)         </td> <td>Accept</td> </tr> </tbody> </table>	Size(mm)	Judgement	$X \leq 3\text{mm}, Y \leq S,$ $Z \leq T$ (S= ITO length, T=Single glass thickness)	Accept
Size(mm)	Judgement					
$X \leq 3\text{mm}, Y \leq S,$ $Z \leq T$ (S= ITO length, T=Single glass thickness)	Accept					
<p>11.3.3.6</p>	<p><b>Glass Defect- Side fragment</b></p>	 <table border="1" data-bbox="702 862 1412 1075"> <thead> <tr> <th>Size(mm)</th> <th>Judgement</th> </tr> </thead> <tbody> <tr> <td> <math>X \leq 2 \text{ mm}, Y \leq \text{border edge}</math>  <math>Z \leq T</math>            (T= single glass thickness)         </td> <td>Accept</td> </tr> </tbody> </table>	Size(mm)	Judgement	$X \leq 2 \text{ mm}, Y \leq \text{border edge}$ $Z \leq T$ (T= single glass thickness)	Accept
Size(mm)	Judgement					
$X \leq 2 \text{ mm}, Y \leq \text{border edge}$ $Z \leq T$ (T= single glass thickness)	Accept					

**11.3.4 Minor defect (Touch Panel)**

Item No.	Inspection content	Judgement								
<p>11.3.4.1</p>	<p>Scratch, dust, particles, foreign materials in “linear type”</p>	<table border="1" data-bbox="702 1400 1412 1668"> <thead> <tr> <th>Size (mm)</th> <th>Acceptable Q'ty</th> </tr> </thead> <tbody> <tr> <td><math>W \leq 0.05\text{mm}, L \leq 10\text{mm}</math></td> <td>Ignore</td> </tr> <tr> <td><math>0.05\text{mm} &lt; W \leq 0.07\text{mm}, L \leq 10\text{mm}</math></td> <td>3</td> </tr> <tr> <td><math>W &gt; 0.07\text{mm}</math></td> <td>Reject</td> </tr> </tbody> </table>	Size (mm)	Acceptable Q'ty	$W \leq 0.05\text{mm}, L \leq 10\text{mm}$	Ignore	$0.05\text{mm} < W \leq 0.07\text{mm}, L \leq 10\text{mm}$	3	$W > 0.07\text{mm}$	Reject
Size (mm)	Acceptable Q'ty									
$W \leq 0.05\text{mm}, L \leq 10\text{mm}$	Ignore									
$0.05\text{mm} < W \leq 0.07\text{mm}, L \leq 10\text{mm}$	3									
$W > 0.07\text{mm}$	Reject									
<p>11.3.4.2</p>	<p>Scratch, dust, particles, foreign materials in “round type”</p>	<table border="1" data-bbox="702 1736 1412 1971"> <thead> <tr> <th>Diameter (mm)</th> <th>Acceptable Q'ty</th> </tr> </thead> <tbody> <tr> <td><math>\Phi \leq 0.25\text{mm}</math></td> <td>Ignore</td> </tr> <tr> <td><math>0.25\text{mm} &lt; \Phi \leq 0.35\text{mm}</math></td> <td>5</td> </tr> <tr> <td><math>\Phi &gt; 0.35\text{mm}</math></td> <td>Reject</td> </tr> </tbody> </table>	Diameter (mm)	Acceptable Q'ty	$\Phi \leq 0.25\text{mm}$	Ignore	$0.25\text{mm} < \Phi \leq 0.35\text{mm}$	5	$\Phi > 0.35\text{mm}$	Reject
Diameter (mm)	Acceptable Q'ty									
$\Phi \leq 0.25\text{mm}$	Ignore									
$0.25\text{mm} < \Phi \leq 0.35\text{mm}$	5									
$\Phi > 0.35\text{mm}$	Reject									

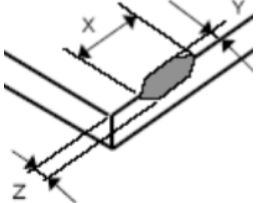
11.3.4.3	Air bubbles	<table border="1"> <thead> <tr> <th>Diameter (mm)</th> <th>Acceptable Q'ty</th> </tr> </thead> <tbody> <tr> <td><math>\Phi \leq 0.2\text{mm}</math></td> <td>Ignore</td> </tr> <tr> <td><math>0.2\text{mm} &lt; \Phi \leq 0.5\text{mm}</math></td> <td>3</td> </tr> <tr> <td><math>\Phi &gt; 0.5\text{mm}</math></td> <td>Reject</td> </tr> </tbody> </table>		Diameter (mm)	Acceptable Q'ty	$\Phi \leq 0.2\text{mm}$	Ignore	$0.2\text{mm} < \Phi \leq 0.5\text{mm}$	3	$\Phi > 0.5\text{mm}$	Reject
		Diameter (mm)	Acceptable Q'ty								
		$\Phi \leq 0.2\text{mm}$	Ignore								
		$0.2\text{mm} < \Phi \leq 0.5\text{mm}$	3								
$\Phi > 0.5\text{mm}$	Reject										
11.3.4.5	Scratch on printing area	<table border="1"> <thead> <tr> <th>Size (mm)</th> <th>Acceptable Q'ty</th> </tr> </thead> <tbody> <tr> <td><math>W \leq 0.03\text{mm}, L \leq 5\text{ mm}</math></td> <td>Ignore</td> </tr> <tr> <td><math>0.03\text{mm} &lt; W \leq 0.05\text{mm}, L \leq 5\text{mm}</math></td> <td>3</td> </tr> <tr> <td><math>W &gt; 0.05\text{mm}</math> or <math>L &gt; 5\text{mm}</math></td> <td>Reject</td> </tr> </tbody> </table>		Size (mm)	Acceptable Q'ty	$W \leq 0.03\text{mm}, L \leq 5\text{ mm}$	Ignore	$0.03\text{mm} < W \leq 0.05\text{mm}, L \leq 5\text{mm}$	3	$W > 0.05\text{mm}$ or $L > 5\text{mm}$	Reject
		Size (mm)	Acceptable Q'ty								
		$W \leq 0.03\text{mm}, L \leq 5\text{ mm}$	Ignore								
		$0.03\text{mm} < W \leq 0.05\text{mm}, L \leq 5\text{mm}$	3								
$W > 0.05\text{mm}$ or $L > 5\text{mm}$	Reject										
11.3.4.6	Corner chipping										
		<table border="1"> <thead> <tr> <th>Size(mm)</th> <th>Judgement</th> </tr> </thead> <tbody> <tr> <td> <math>X \leq 2\text{mm}, Y \leq 2\text{mm}</math>  <math>Z &lt; 1/2 T</math>                      (T= single glass thickness)                 </td> <td>Accept</td> </tr> </tbody> </table>		Size(mm)	Judgement	$X \leq 2\text{mm}, Y \leq 2\text{mm}$ $Z < 1/2 T$ (T= single glass thickness)	Accept				
		Size(mm)	Judgement								
$X \leq 2\text{mm}, Y \leq 2\text{mm}$ $Z < 1/2 T$ (T= single glass thickness)	Accept										
11.3.4.7	Edge chipping										
		<table border="1"> <thead> <tr> <th>Size(mm)</th> <th>Judgement</th> </tr> </thead> <tbody> <tr> <td> <math>X \leq 3\text{ mm}, Y \leq 3\text{ mm}</math>  <math>Z \leq 1/2 T</math>                      (T= single glass thickness)                 </td> <td>Accept</td> </tr> </tbody> </table>		Size(mm)	Judgement	$X \leq 3\text{ mm}, Y \leq 3\text{ mm}$ $Z \leq 1/2 T$ (T= single glass thickness)	Accept				
		Size(mm)	Judgement								
$X \leq 3\text{ mm}, Y \leq 3\text{ mm}$ $Z \leq 1/2 T$ (T= single glass thickness)	Accept										

## 12. Handling Precautions

### 12.1 Mounting method

The LCD panel of AMSON TFT module consists of two thin glass plates with polarizers which easily be damaged. And since the module is so constructed as to be fixed by utilizing fitting holes in the printed circuit board.

Extreme care should be needed when handling the LCD modules.

### 12.2 Caution of LCD handling and cleaning

When cleaning the display surface, Use soft cloth with solvent

[Recommended below] and wipe lightly

- Isopropyl alcohol
- Ethyl alcohol

Do not wipe the display surface with dry or hard materials that will damage the polarizer surface.

Do not use the following solvent:

- Water
- Aromatics

Do not wipe ITO pad area with the dry or hard materials that will damage the ITO patterns

Do not use the following solvent on the pad or prevent it from being contaminated:

- Soldering flux
- Chlorine (Cl) , Sulfur (S)

If goods were sent without being silicon coated on the pad, ITO patterns could be damaged due to the corrosion as time goes on.

If ITO corrosion happens by miss-handling or using some materials such as Chlorine (Cl), Sulfur (S) from customer, Responsibility is on customer.

### 12.3 Caution against static charge

The LCD module uses C-MOS LSI drivers, so we recommend that you:

Connect any unused input terminal to VDD or GND, do not input any signals before power is turned on, and ground your body, work/assembly areas, and assembly equipment to protect against static electricity.

### 12.4 packing

- Module employs LCD elements and must be treated as such.
- Avoid intense shock and falls from a height.
- To prevent modules from degradation, do not operate or store them exposed direct to sunshine or high temperature/humidity

### 12.5 Caution for operation

- It is an indispensable condition to drive LCD's within the specified voltage limit since the higher voltage than the limit causes the shorter LCD life.
- An electrochemical reaction due to direct current causes LCD's undesirable deterioration, so that the use of direct current drive should be avoided.
- Response time will be extremely delayed at lower temperature than the operating temperature range and on the other hand at higher temperature LCD's show dark color in them. However those phenomena do not mean malfunction or out of order with LCD's, which will come back in the specified operation temperature.
- If the display area is pushed hard during operation, some font will be abnormally displayed but it resumes normal condition after turning off once.
- Slight dew depositing on terminals is a cause for electro-chemical reaction resulting in terminal open circuit.

Usage under the maximum operating temperature, 50%Rh or less is required.

## 12.6 storing

In the case of storing for a long period of time for instance, for years for the purpose or replacement use, the following ways are recommended.

- Storage in a polyethylene bag with the opening sealed so as not to enter fresh air outside in it. And with no desiccant.
- Placing in a dark place where neither exposure to direct sunlight nor light's keeping the storage temperature range.
- Storing with no touch on polarizer surface by the anything else.  
[It is recommended to store them as they have been contained in the inner container at the time of delivery from us

## 12.7 Safety

- It is recommendable to crash damaged or unnecessary LCD's into pieces and wash off liquid crystal by either of solvents such as acetone and ethanol, which should be burned up later.
- When any liquid leaked out of a damaged glass cell comes in contact with your hands, please wash it off well with soap and water

## 13. Precaution for Use

### 13.1

A limit sample should be provided by the both parties on an occasion when the both parties agreed its necessity. Judgment by a limit sample shall take effect after the limit sample has been established and confirmed by the both parties.

### 13.2

On the following occasions, the handing of problem should be decided through discussion and agreement between responsible of the both parties.

- When a question is arisen in this specification
- When a new problem is arisen which is not specified in this specifications
- When an inspection specifications change or operating condition change in customer is reported to AMSON TFT , and some problem is arisen in this specification due to the change
- When a new problem is arisen at the customer's operating set for sample evaluation in the customer site.

## 14. Packing Method

**TBD**