

Specification for Approval

Customer: _____

Model Name: _____

| Supplier Approval | | | Customer approval |
|-------------------|-----------------|-------------|-------------------|
| R&D Designed | R&D Approved | QC Approved | |
| <i>Peter</i> | <i>Peng Jun</i> | | |

Table of Contents

| List | Description | Page No. |
|------|---|----------|
| | Cover | 1 |
| | Revision Record | 2 |
| | Table of Contents | 3 |
| 1 | Scope | 4 |
| 2 | General Information | 4 |
| 3 | External Dimensions | 5 |
| 4 | Interface Description | 6 |
| 5 | Absolute Maximum Ratings | 7 |
| 6 | DC Characteristics | 7 |
| 7 | Timing Characteristics | 8 |
| 8 | Backlight Characteristics | 12 |
| 9 | Optical Characteristics | 13 |
| 10 | Reliability Test Conditions And Methods | 15 |
| 11 | Inspection Standard | 16 |
| 12 | Handling Precautions | 20 |
| 13 | Precaution for Use | 21 |
| 14 | Packing Method | 21 |

1. Scope

This specification defines general provisions as well as inspection standards for TFT module supplied by AMSON electronics.

If the event of unforeseen problem or unspecified items may occur, naturally shall negotiate and agree to solution

2. General Information

| ITEM | STANDARD VALUES | UNITS |
|------------------------|--------------------------------------|-------|
| LCD type | 1.77" TFT | -- |
| Dot arrangement | 128(RGB)×160 | dots |
| Color filter array | RGB vertical stripe | -- |
| Display mode | TN / Transmission / Normally White | - |
| Eyes Viewing Direction | 12 O'clock | -- |
| Driver IC | ST7735S | -- |
| Module size | 33.3(W)×42.94(H)×2.1(T)(Exclude FPC) | mm |
| Active area | 28.03(W)×35.04(H) | mm |
| Interface | 4-SPI / 8 BIT MUC | -- |
| Operating temperature | -20 ~ +70 | °C |
| Storage temperature | -30 ~ +80 | °C |
| Back Light | White LED*2 | -- |

3. External Dimensions

Dimensions: 30.00±0.5, 42.94±0.2(LCM OUTLINE), 35.64(VA), 35.04(LCD AA), 1.97, 2.27, 33.30±0.2(LCM OUTLINE), 28.63(VA), 28.03(LCD AA), 2.63, 2.33, 2.10±0.2, 11.40±0.5, 0.35, W=0.30, P=0.50, 3.00±0.5, 0.30±0.05 FPC+P1.

Dimensions: 4.50±0.5, 10.50.

LED A ○ LED B

LED WHITE, 2 LED, 180mits
TPY: 3.2V, 40mA

NOTES:

1. DISPLAY TYPE: 1.77" LCD
2. VIEWING DIRECTION: 12 o'clock
3. LCD DRIVE IC: ST7735S
4. OPERATING TEMP: -20°C ~ +70°C
5. STORAGE TEMP: -30°C ~ +80°C
6. UNMARKER TOLERANCE: ±0.20
7. REQUIREMENTS ON ENVIRONMENTAL PROTECTION: RoHS
8. LCM BACKLIGHTS: 180 cd/m² (TYP)

TFT INTERFACE

| Pin | NAME |
|-----|--------|
| 1 | GND |
| 2 | /RESET |
| 3 | DB7 |
| 4 | DB6 |
| 5 | DB5 |
| 6 | DB4 |
| 7 | DB3 |
| 8 | DB2 |
| 9 | DB1 |
| 10 | DB0 |
| 11 | IM1 |
| 12 | RD |
| 13 | WR |
| 14 | RS |
| 15 | /CS |
| 16 | 10VCC |
| 17 | VCI |
| 18 | LEDA |
| 19 | LEDB |
| 20 | IM2 |

| IM1 | IM2 | Interface |
|-----|-----|----------------|
| 0 | 0 | 4-line SPI |
| 0 | 1 | 8-bit Parallel |

*0" is D0ND Level, "1" is VCI Level.

| SM | DESCRIPTION OF REVISION | REASON | REVISED BY | DATE |
|----|-------------------------|--------|------------|------------|
| △0 | first issue | A | XG.SU | 2018/11/08 |

Amson logo

于都上晴电子有限公司
YU DU AMSON ELECTRONICS Co., Ltd.

TITLE: OUTLINE DIMENSION
D/N: AM128160-018H

DRAWN BY: _____
CHECKED BY: _____
APPROVED BY: _____

Rev: A
SCALE: 1:1
SHEET NO. 1 OF 1

UNIT: mm

4. Interface Description

| LCM PIN NO. | PIN NAME | DESCRIPTION |
|-------------|----------|--|
| 1 | GND | Power ground |
| 2 | /RESET | Reset input pin, Active "L". |
| 3-9 | DB7-DB1 | DATA BUS |
| 10 | DB0 | DATA BUS in MCU parallel interface, D0 is the serial input/output signal in serial interface mode |
| 11 | IM1 | MCU Parallel Interface Type Selection |
| 12 | RD | Read Enable in 8080 MCU Parallel Interface |
| 13 | WR | Write Enable in MCU Parallel Interface |
| 14 | RS | Display data/command Selection Pin in MCU Interface, In Serial Interface, this is used as SCL |
| 15 | /CS | Chip select input pin ("Low" enable). |
| 16 | IOVCC | IO System power supply. |
| 17 | VCI | System power supply. |
| 18 | LEDA | LED backlight (Anode). |
| 19 | LEDK | LED backlight (Cathode). |
| 20 | IM2 | MCU Parallel Interface Bus and Serial Interface select |

Note:

| IM1 | IM2 | Interface |
|-----|-----|-----------|
| 0 | 0 | 4-SPI |
| 0 | 1 | 8 BIT MUC |

5. Absolute Maximum Ratings

| Item | Symbol | Min. | Max. | Unit |
|-----------------------|--------|------|------|------|
| Analog supply voltage | VCI | -0.3 | 4.8 | V |
| Logic Supply Voltage | IOVCC | -0.3 | 4.8 | V |
| Operating Temperature | TOP | -20 | 70 | °C |
| Storage Temperature | TST | -30 | 80 | °C |
| Storage Humidity | HD | 20 | 90 | %RH |

6. DC Characteristics

| Item | Symbol | Min. | Typ. | Max. | Unit | Remark |
|-----------------------|--------|---------|------|---------|------|--------|
| Analog Supply Voltage | VCI | 2.5 | 2.75 | 3.3 | V | - |
| Logic Supply Voltage | IOVCC | 1.65 | 1.8 | 3.3 | V | - |
| Input High Voltage | VIH | 0.7VDD | - | VDD | V | - |
| Input Low Voltage | VIL | GND | - | 0.3 VDD | V | - |
| Output High Voltage | VOH | 0.8 VDD | - | VDD | V | - |
| Output Low Voltage | VOL | GND | - | 0.2 VDD | V | - |
| I/O Leak Current | ILI | -1 | - | 1 | uA | - |

7. Timing Characteristics

7.1 Power on/off timing sequence

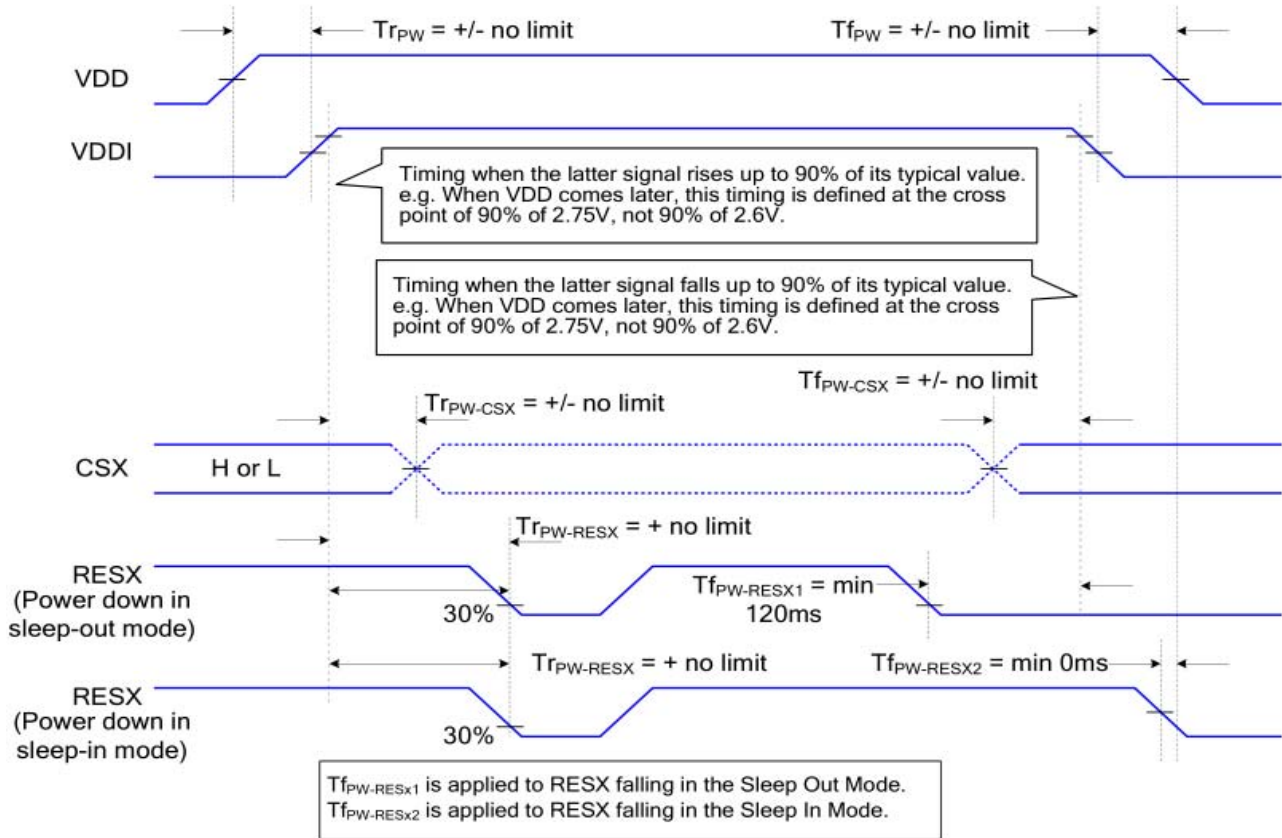

7.2 Reset Timing

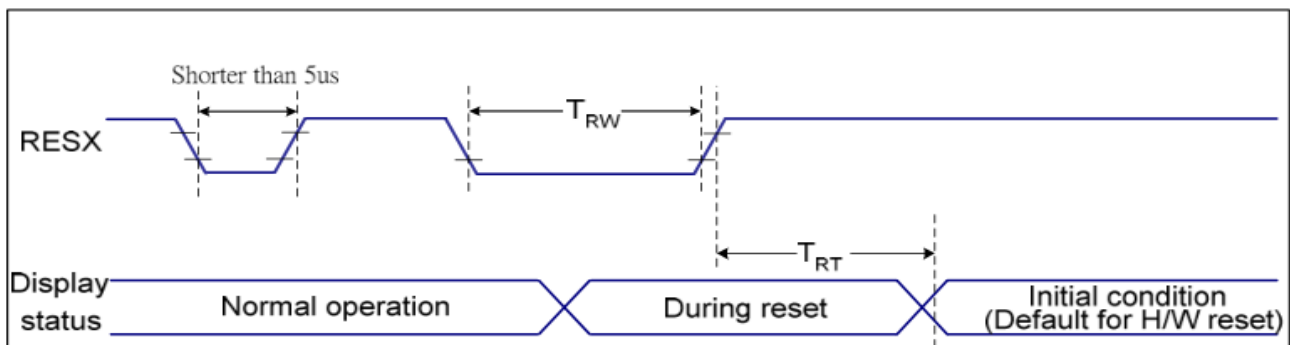

| Related Pins | Symbol | Parameter | MIN | MAX | Unit |
|--------------|--------|----------------------|--------------------|---------------|------|
| RESX | TRW | Reset pulse duration | 10 | - | us |
| | TRT | Reset cancel | - | 5 (Note 1, 5) | ms |
| - | | | 120 (Note 1, 6, 7) | ms | |

7.3 Parallel CPU 18/16/9/8-bit Bus

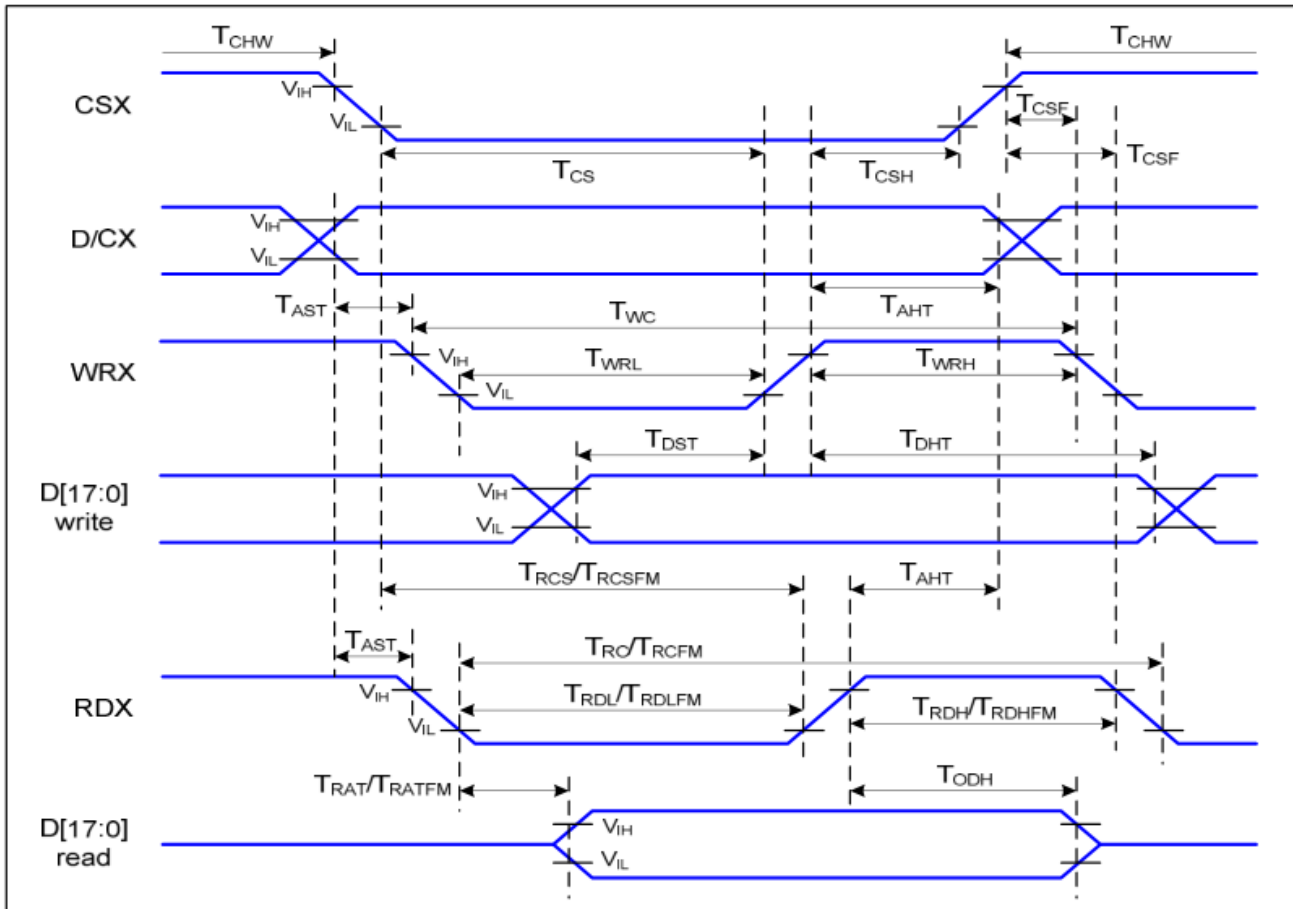

| Signal | Symbol | Parameter | Min | Max | Unit | Description |
|----------|--------|------------------------------------|-----|-----|------|-------------------|
| D/CX | TAST | Address Setup Ttime | 0 | | ns | |
| | TAHT | Address Hold Time (Write/Read) | 10 | | ns | |
| CSX | TCHW | Chip Select "H" Pulse Width | 0 | | ns | |
| | TCS | Chip Select Setup Time (Write) | 15 | | ns | |
| | TRCS | Chip Select Setup Time (Read ID) | 45 | | ns | |
| | TRCSFM | Chip Select Setup time (Read FM) | 355 | | ns | |
| | TCSF | Chip Select Wait Time (Write/Read) | 10 | | ns | |
| | TCSH | Chip Select Hold Time | 10 | | ns | |
| WRX | TWC | Write Cycle | 66 | | ns | |
| | TWRH | Control Pulse "H" Duration | 15 | | ns | |
| | TWRL | Control Pulse "L" Duration | 15 | | ns | |
| RDX (ID) | TRC | Read Cycle (ID) | 160 | | ns | When Read ID Data |
| | TRDH | Control Pulse "H" Duration (ID) | 90 | | ns | |
| | TRDL | Control Pulse "L" Duration (ID) | 45 | | ns | |



AM-128160-018H

Version: A

2018-11-22

| | | | | | | |
|-------------|--------|---------------------------------|-----|-----|----|--------------------------------|
| RDX (FM) | TRCFM | Read Cycle (FM) | 450 | | ns | When Read from Frame Memory |
| | TRDHFM | Control Pulse "H" Duration (FM) | 90 | | ns | |
| | TRDLFM | Control Pulse "L" Duration (FM) | 355 | | ns | |
| D[17:0] | TDST | Data Setup Time | 10 | | ns | For CL=30pF |
| | TDHT | Data Hold Time | 10 | | ns | |
| | TRAT | Read Access Time (ID) | | 40 | ns | |
| | TRATFM | Read Access Time (FM) | | 340 | ns | |
| | TODH | Output Disable Time | 20 | 80 | ns | |

7.4 Serial Interface Characteristics (4line)

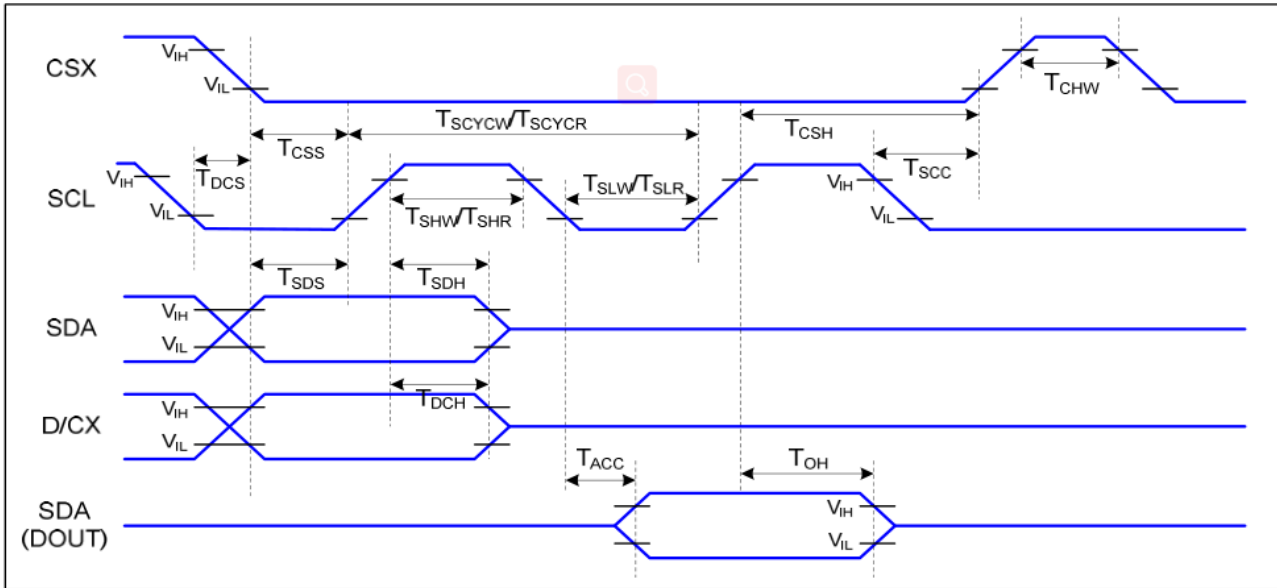

| Signal | Symbol | Parameter | MIN | MAX | Unit | Description |
|------------------|--------|--------------------------------|-----|-----|------|---|
| CSX | TCSS | Chip Select Setup Time (Write) | 45 | | ns | |
| | TCSH | Chip Select Hold Time (Write) | 45 | | ns | |
| | TCSS | Chip Select Setup Time (Read) | 60 | | ns | |
| | TSCC | Chip Select Hold Time (Read) | 65 | | ns | |
| | TCHW | Chip Select "H" Pulse Width | 40 | | ns | |
| SCL | TSCYCW | Serial Clock Cycle (Write) | 66 | | ns | -Write Command & Data Ram |
| | TSHW | SCL "H" Pulse Width (Write) | 15 | | ns | |
| | TSLW | SCL "L" Pulse Width (Write) | 15 | | ns | |
| | TSCYCR | Serial Clock Cycle (Read) | 150 | | ns | -Read Command & Data Ram |
| | TSHR | SCL "H" Pulse Width (Read) | 60 | | ns | |
| | TSLR | SCL "L" Pulse Width (Read) | 60 | | ns | |
| D/CX | TDCS | D/CX Setup Time | 10 | | ns | |
| | TDCH | D/CX Hold Time | 10 | | ns | |
| SDA (DIN) (DOUT) | TSDS | Data Setup Time | 10 | | ns | For Maximum $CL=30pF$ For Minimum $CL=8pF$ |
| | TSDH | Data Hold Time | 10 | | ns | |
| | TACC | Access Time | 10 | 50 | ns | |
| | TOH | Output Disable Time | 15 | 50 | ns | |

8. Backlight Characteristics

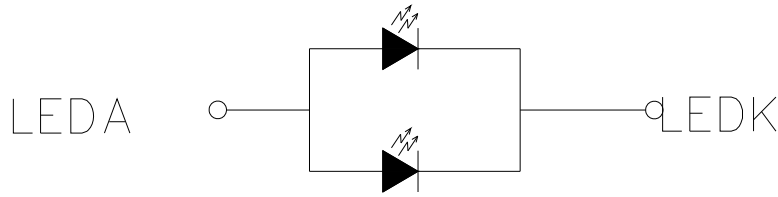

BL CIRCUIT DIAGRAM

| Item | Symbol | MIN | TYP | MAX | UNIT | Test Condition |
|----------------------------|--------|-------|-----|-----|-------------------|----------------|
| Supply Voltage | Vf | 3.0 | 3.2 | 3.6 | V | If=40mA |
| Supply Current | If | - | 40 | - | mA | - |
| Luminous Intensity for LCM | - | 130 | 180 | - | cd/m ² | If=40mA |
| Uniformity for LCM | - | 80 | - | - | % | If=40mA |
| Life Time | - | 20000 | - | - | Hr | If=40mA |
| Backlight Color | White | | | | | |

9. Optical Characteristics

| Item | Conditions | Min. | Typ. | Max. | Unit | Note | |
|---------------------------------------|----------------|---------------|------|---------------|------|-------------|-------------|
| Viewing Angle (CR>10) | Horizontal | θ_L | 40 | 45 | - | degree | (1),(2),(6) |
| | | θ_R | 40 | 45 | - | | |
| | Vertical | θ_T | 40 | 45 | - | | |
| | | θ_B | 15 | 20 | - | | |
| Contrast Ratio | Center | 200 | 300 | - | - | (1),(3),(6) | |
| Response Time | Rising+Falling | - | 30 | 60 | ms | (1),(4),(6) | |
| CF Color Chromaticity (CIE1931) | Red x | Typ. -0.05 | TBD | Typ. +0.05 | - | (1), (6) | |
| | Red y | | TBD | | - | | |
| | Green x | | TBD | | - | | |
| | Green y | | TBD | | - | | |
| | Blue x | | TBD | | - | | |
| | Blue y | | TBD | | - | | |
| | White x | | TBD | | - | | |
| | White y | | TBD | | - | | |
| transmittance | tr | - | 6.9 | - | % | (1),(6) | |

Note (1) Measurement Setup: The LCD module should be stabilized at given temp. 25°C for 15 minutes to avoid abrupt temperature change during measuring. In order to stabilize the luminance, the measurement should be executed after lighting backlight for 15 minutes in a windless room.

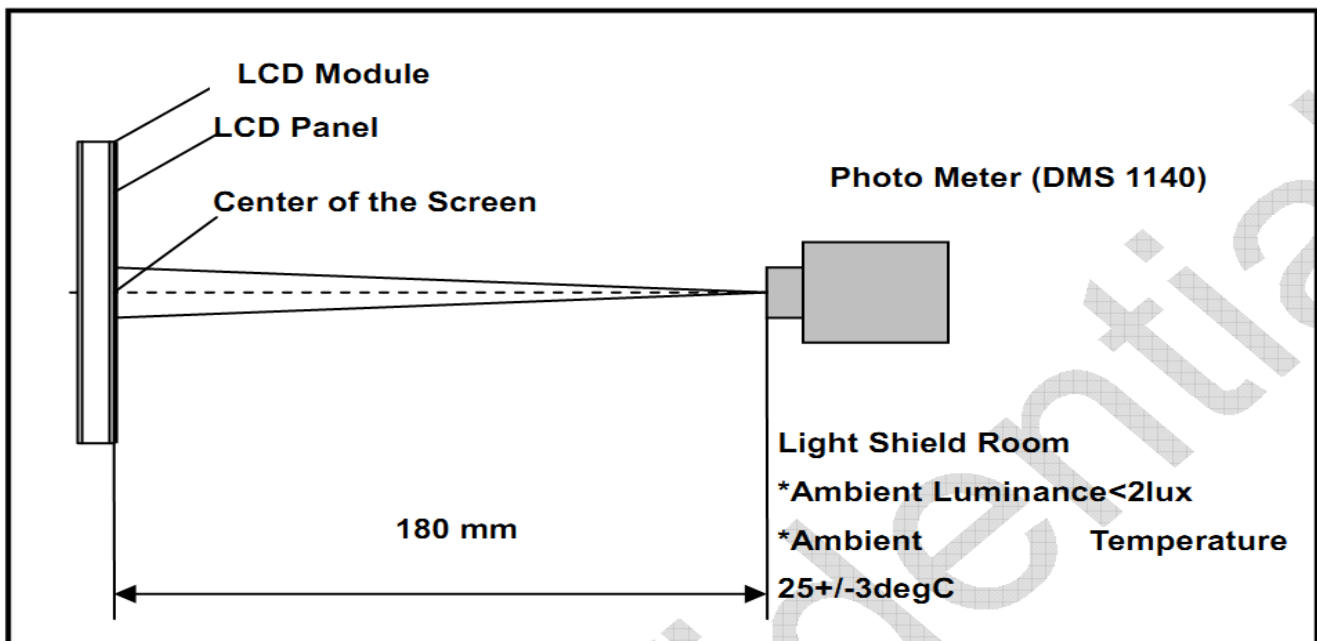

Note (2) Definition of Viewing Angle

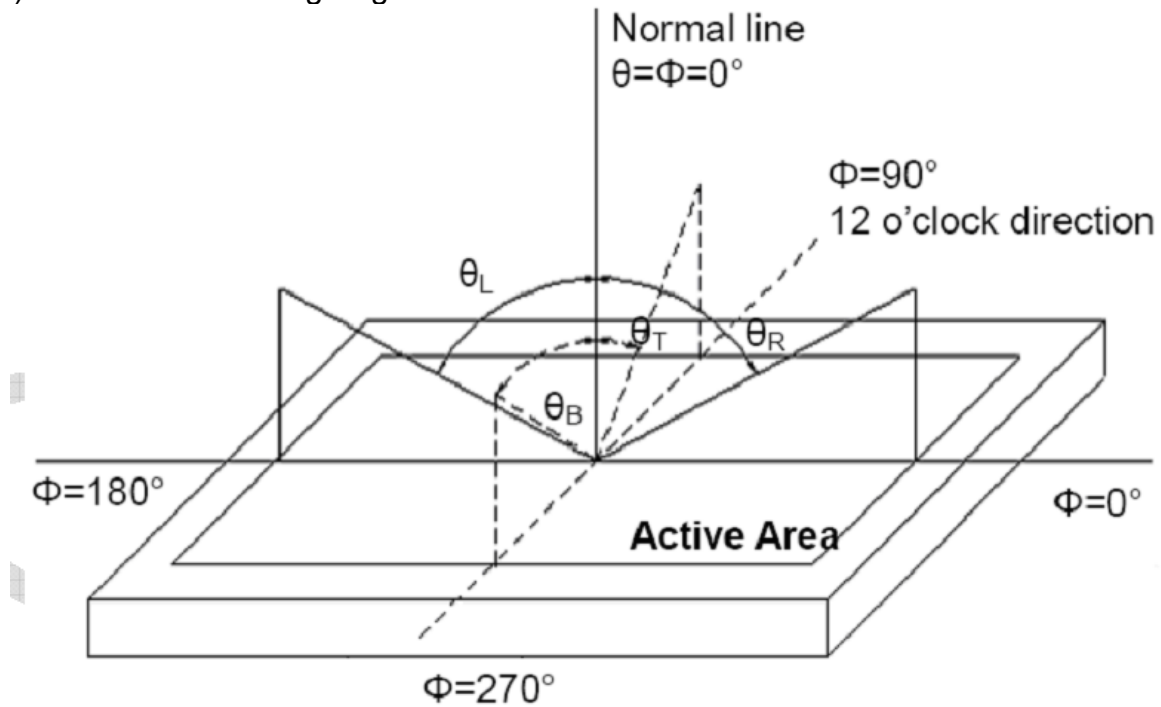

Note (3) Definition Of Contrast Ratio (CR)

The contrast ratio can be calculated by the following expression

$$\text{Contrast Ratio (CR)} = L_{63} / L_0$$

L63: Luminance of gray level 63, L0: Luminance of gray level 0

Note (4) Definition of response time

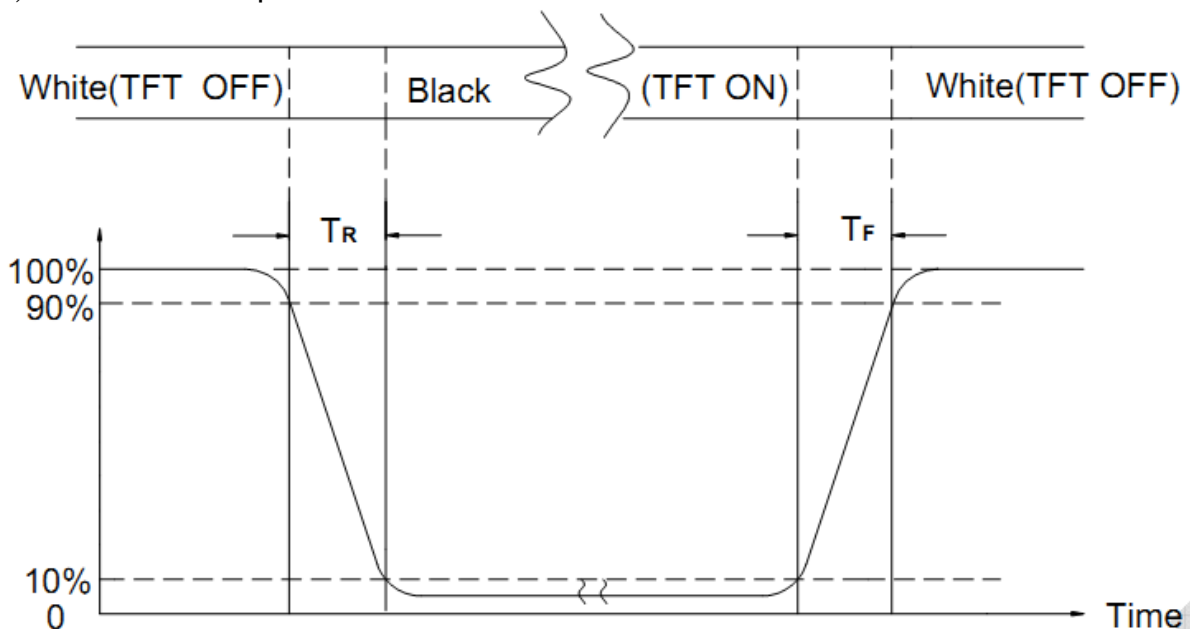

Note (5) Definition of Transmittance (Module is without signal input)

$$\text{Transmittance} = \text{Center Luminance of LCD} / \text{Center Luminance of Back Light} \times 100\%$$

Note (6) Definition of color chromaticity (CIE1931)

Color coordinates measured at the center point of LCD

10. Reliability Test Conditions and Methods

| NO. | TEST ITEMS | TEST CONDITION | INSPECTION AFTER TEST |
|--------------------------|----------------------------|--|---|
| <input type="checkbox"/> | High Temperature Storage | 80°C±2°C×96Hours | Inspection after 2~4hours storage at room temperature, the samples should be free from defects: 1, Air bubble in the LCD. 2, Seal leak. 3, Non-display. 4, Missing segments. 5, Glass crack. 6, Current IDD is twice higher than initial value. 7, The surface shall be free from damage. 8, The electric characteristic requirements shall be satisfied. |
| <input type="checkbox"/> | Low Temperature Storage | -30°C±2°C×96Hours | |
| <input type="checkbox"/> | High Temperature Operating | 70°C±2°C×96Hours | |
| <input type="checkbox"/> | Low Temperature Operating | -20°C±2°C×96Hours | |
| <input type="checkbox"/> | Temperature Cycle(Storage) | -20°C ↔ 25°C ↔ 70°C (30min) ← (5min) → (30min) 1cycle Total 10cycle | |
| <input type="checkbox"/> | Damp Proof Test (Storage) | 50°C±5°C×90%RH×96Hours | |
| <input type="checkbox"/> | Vibration Test | Frequency:10Hz~55Hz~10Hz Amplitude:1.5MM X,Y,Z direction for total 3hours (packing condition test will be tested by a carton) | |
| <input type="checkbox"/> | Drooping Test | Drop to the ground from 1M height one time every side of carton. (packing condition test will be tested by a carton) | |
| <input type="checkbox"/> | ESD Test | Voltage:±8KV,R:330Ω,C:150PF,Air Mode,10times | |

REMARK:

- 1, The Test samples should be applied to only one test item.
- 2, Sample side for each test item is 5~10pcs.
- 3,For Damp Proof Test, Pure water(Resistance > 10MΩ)should be used.
- 4,In case of malfunction defect caused by ESD damage, if it would be recovered to normal state after resetting, it would be judge as a good part.
- 5, EL evaluation should be accepted from reliability test with humidity and temperature: Some defects such as black spot/blemish can happen by natural chemical reaction with humidity and Fluorescence EL has.
- 6, Failure Judgment Criterion: Basic Specification Electrical Characteristic, Mechanical Characteristic, Optical Characteristic.

11. Inspection Standard

11.1 Incoming Inspection and Standard:

The below incoming inspection are applied to the TFT LCM Modules supplied by AMSON Optoelectronic Industry CO.,LTD. The customers should inspect the LCM within 14 days after receiving the goods. The result of inspection should be notified to the Seller in the writing copy promptly, if the customer do not send them within 14 days, the seller has the right to judge as acceptance of goods. The inspection lot size is treated as the quantity per shipment and per model. The sampling plan shall be inspected under MIL-STD015E in Level II by single sampling. The acceptable quality level (AQL) are categorized as below grades:

CRITICAL= 0.65%, MAJOR= 0.65%, MINOR= 1.5%

11.2 Inspection condition and Warranty policy:

The delivered LCM should be stored properly, ideally under climate-controlled environment at 25 (±5) degree Celsius as well as 60% (±10) Relative Humidity. The LCM shall be inspected in the viewing angle of 45 degree from the four major angles (U/D/L/R) under the single fluorescent lamp of 20W (equal to 300 to 500 lux). For warranty, AMSON Optoelectronic Industry CO.,LTD. will provide 12 months of warranty period as standard, and provide the new replacement for the defective products which belong to the Seller's responsibility verified by the quality department.

11.3 Inspection Criteria:

11.3.1 Critical defect (重度缺失)

| Item No. | Inspection content | Judgement |
|----------|--------------------|--|
| 11.3.1.1 | Functional defects | No display, abnormal display, short circuit, missing line, off-contrast and chromaticity, Touch Panel non-function |
| 11.3.1.2 | Model mixed | Other model mixed |

11.3.2 Major defect: (主要缺失)

| Item No. | Inspection content | Judgement |
|----------|--------------------|--|
| 11.3.2.1 | Product indication | Missing model no. and wrong model no. is indicated on the LCM. |
| 11.3.2.2 | Glass cracking | The LCD and touch panel glass crack or breakage |
| 11.3.2.3 | Missing component | The function component missing such as connector, cable, etc. |

11.3.3 Minor defect (LCD) : (次要缺失)

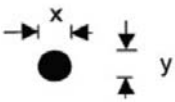
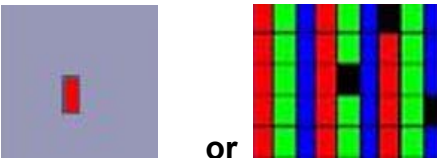
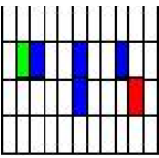
| Item No. | Inspection content | Judgement | | | | | | | | | | | | |
|------------------------|---|--|---------------|-----------------|-----------------|----------------------------|------------------------|----------------------------|---------------|----------------------|---|--|------------|-----------------|
| 11.3.3.1 | Black/White spot Foreign particles Dust in the cell | $\phi = (x+y) / 2$  <table border="1"> <thead> <tr> <th>Diameter (mm)</th> <th>Acceptable Q'ty</th> </tr> </thead> <tbody> <tr> <td>$\Phi \leq 0.1$</td> <td>Ignore</td> </tr> <tr> <td>$0.1 < \Phi \leq 0.25$</td> <td>3 (Distance>5mm)</td> </tr> <tr> <td>$0.25 < \Phi$</td> <td>Not allowed</td> </tr> </tbody> </table> | Diameter (mm) | Acceptable Q'ty | $\Phi \leq 0.1$ | Ignore | $0.1 < \Phi \leq 0.25$ | 3 (Distance>5mm) | $0.25 < \Phi$ | Not allowed | | | | |
| Diameter (mm) | Acceptable Q'ty | | | | | | | | | | | | | |
| $\Phi \leq 0.1$ | Ignore | | | | | | | | | | | | | |
| $0.1 < \Phi \leq 0.25$ | 3 (Distance>5mm) | | | | | | | | | | | | | |
| $0.25 < \Phi$ | Not allowed | | | | | | | | | | | | | |
| 11.3.3.2 | Linear defect Black/white line Black/white scratch | <table border="1"> <thead> <tr> <th>Length(mm)</th> <th>Width (mm)</th> <th>Acceptable Q'ty</th> </tr> </thead> <tbody> <tr> <td></td> <td>$W \leq 0.03$</td> <td>Ignore</td> </tr> <tr> <td>$L \leq 5.0$</td> <td>$0.03 < W \leq 0.07$</td> <td>3</td> </tr> <tr> <td></td> <td>$0.07 < W$</td> <td>Follow 11.3.3.1</td> </tr> </tbody> </table> | Length(mm) | Width (mm) | Acceptable Q'ty | | $W \leq 0.03$ | Ignore | $L \leq 5.0$ | $0.03 < W \leq 0.07$ | 3 | | $0.07 < W$ | Follow 11.3.3.1 |
| Length(mm) | Width (mm) | Acceptable Q'ty | | | | | | | | | | | | |
| | $W \leq 0.03$ | Ignore | | | | | | | | | | | | |
| $L \leq 5.0$ | $0.03 < W \leq 0.07$ | 3 | | | | | | | | | | | | |
| | $0.07 < W$ | Follow 11.3.3.1 | | | | | | | | | | | | |
| 11.3.3.3 | Polarizer Bubbles Dent on polarizer | <table border="1"> <thead> <tr> <th>Diameter (mm)</th> <th>Acceptable Q'ty</th> </tr> </thead> <tbody> <tr> <td>$\Phi \leq 0.2$</td> <td>Ignore</td> </tr> <tr> <td>$0.2 < \Phi \leq 0.5$</td> <td>2 (Distance>5mm)</td> </tr> <tr> <td>$0.5 < \Phi$</td> <td>Not allowed</td> </tr> </tbody> </table> | Diameter (mm) | Acceptable Q'ty | $\Phi \leq 0.2$ | Ignore | $0.2 < \Phi \leq 0.5$ | 2 (Distance>5mm) | $0.5 < \Phi$ | Not allowed | | | | |
| Diameter (mm) | Acceptable Q'ty | | | | | | | | | | | | | |
| $\Phi \leq 0.2$ | Ignore | | | | | | | | | | | | | |
| $0.2 < \Phi \leq 0.5$ | 2 (Distance>5mm) | | | | | | | | | | | | | |
| $0.5 < \Phi$ | Not allowed | | | | | | | | | | | | | |
| 11.3.3.4 | Electrical defect Dot | <p>Bright dot and Dark dot definition:</p>  <p>or</p>  <p>(Two adjacent dot)</p> <p>Inspection pattern: black, white, red, green, and blue screen.</p> <table border="1"> <thead> <tr> <th>Items</th> <th>Acceptable Q'ty</th> </tr> </thead> <tbody> <tr> <td>Bright dot</td> <td>$N \leq 4$ (Distance >5mm)</td> </tr> <tr> <td>Dark dot</td> <td>$N \leq 4$ (Distance >5mm)</td> </tr> </tbody> </table> | Items | Acceptable Q'ty | Bright dot | $N \leq 4$ (Distance >5mm) | Dark dot | $N \leq 4$ (Distance >5mm) | | | | | | |
| Items | Acceptable Q'ty | | | | | | | | | | | | | |
| Bright dot | $N \leq 4$ (Distance >5mm) | | | | | | | | | | | | | |
| Dark dot | $N \leq 4$ (Distance >5mm) | | | | | | | | | | | | | |

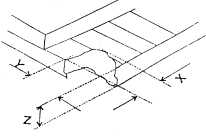
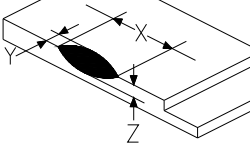
| 11.3.3.5 | Glass Defect- Corner chipping |  <table border="1" data-bbox="703 389 1410 665"> <thead> <tr> <th>Size(mm)</th> <th>Judgement</th> </tr> </thead> <tbody> <tr> <td> $X \leq 3\text{mm}$, $Y \leq S$, $Z \leq T$ (S= ITO length, T=Single glass thickness) </td> <td>Accept</td> </tr> </tbody> </table> | Size(mm) | Judgement | $X \leq 3\text{mm}$, $Y \leq S$, $Z \leq T$ (S= ITO length, T=Single glass thickness) | Accept |
|---|--|---|----------|-----------|---|--------|
| Size(mm) | Judgement | | | | | |
| $X \leq 3\text{mm}$, $Y \leq S$, $Z \leq T$ (S= ITO length, T=Single glass thickness) | Accept | | | | | |
| 11.3.3.6 | Glass Defect- Side fragment |  <table border="1" data-bbox="703 862 1410 1072"> <thead> <tr> <th>Size(mm)</th> <th>Judgement</th> </tr> </thead> <tbody> <tr> <td> $X \leq 2\text{ mm}$, $Y \leq \text{border edge}$ $Z \leq T$ (T= single glass thickness) </td> <td>Accept</td> </tr> </tbody> </table> | Size(mm) | Judgement | $X \leq 2\text{ mm}$, $Y \leq \text{border edge}$ $Z \leq T$ (T= single glass thickness) | Accept |
| Size(mm) | Judgement | | | | | |
| $X \leq 2\text{ mm}$, $Y \leq \text{border edge}$ $Z \leq T$ (T= single glass thickness) | Accept | | | | | |

11.3.4 Minor defect (Touch Panel)

| Item No. | Inspection content | Judgement | | | | | | | | |
|---|---|---|---------------|-----------------|---|--------|---|---|------------------------|--------|
| 11.3.4.1 | Scratch, dust, particles, foreign materials in "linear type" | <table border="1" data-bbox="703 1397 1410 1662"> <thead> <tr> <th>Size (mm)</th> <th>Acceptable Q'ty</th> </tr> </thead> <tbody> <tr> <td>$W \leq 0.05\text{mm}$, $L \leq 10\text{mm}$</td> <td>Ignore</td> </tr> <tr> <td>$0.05\text{mm} < W \leq 0.07\text{mm}$, $L \leq 10\text{mm}$</td> <td>3</td> </tr> <tr> <td>$W > 0.07\text{mm}$</td> <td>Reject</td> </tr> </tbody> </table> | Size (mm) | Acceptable Q'ty | $W \leq 0.05\text{mm}$, $L \leq 10\text{mm}$ | Ignore | $0.05\text{mm} < W \leq 0.07\text{mm}$, $L \leq 10\text{mm}$ | 3 | $W > 0.07\text{mm}$ | Reject |
| Size (mm) | Acceptable Q'ty | | | | | | | | | |
| $W \leq 0.05\text{mm}$, $L \leq 10\text{mm}$ | Ignore | | | | | | | | | |
| $0.05\text{mm} < W \leq 0.07\text{mm}$, $L \leq 10\text{mm}$ | 3 | | | | | | | | | |
| $W > 0.07\text{mm}$ | Reject | | | | | | | | | |
| 11.3.4.2 | Scratch, dust, particles, foreign materials in "round type" | <table border="1" data-bbox="703 1738 1410 1971"> <thead> <tr> <th>Diameter (mm)</th> <th>Acceptable Q'ty</th> </tr> </thead> <tbody> <tr> <td>$\Phi \leq 0.25\text{mm}$</td> <td>Ignore</td> </tr> <tr> <td>$0.25\text{mm} < \Phi \leq 0.35\text{mm}$</td> <td>5</td> </tr> <tr> <td>$\Phi > 0.35\text{mm}$</td> <td>Reject</td> </tr> </tbody> </table> | Diameter (mm) | Acceptable Q'ty | $\Phi \leq 0.25\text{mm}$ | Ignore | $0.25\text{mm} < \Phi \leq 0.35\text{mm}$ | 5 | $\Phi > 0.35\text{mm}$ | Reject |
| Diameter (mm) | Acceptable Q'ty | | | | | | | | | |
| $\Phi \leq 0.25\text{mm}$ | Ignore | | | | | | | | | |
| $0.25\text{mm} < \Phi \leq 0.35\text{mm}$ | 5 | | | | | | | | | |
| $\Phi > 0.35\text{mm}$ | Reject | | | | | | | | | |

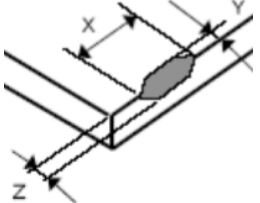
| 11.3.4.3 | Air bubbles | <table border="1"> <thead> <tr> <th>Diameter (mm)</th> <th>Acceptable Q'ty</th> </tr> </thead> <tbody> <tr> <td>$\Phi \leq 0.2\text{mm}$</td> <td>Ignore</td> </tr> <tr> <td>$0.2\text{mm} < \Phi \leq 0.5\text{mm}$</td> <td>3</td> </tr> <tr> <td>$\Phi > 0.5\text{mm}$</td> <td>Reject</td> </tr> </tbody> </table> | | Diameter (mm) | Acceptable Q'ty | $\Phi \leq 0.2\text{mm}$ | Ignore | $0.2\text{mm} < \Phi \leq 0.5\text{mm}$ | 3 | $\Phi > 0.5\text{mm}$ | Reject |
|---|--------------------------|---|-----------------|---------------|-----------------|---|--------|---|---|---|--------|
| | | Diameter (mm) | Acceptable Q'ty | | | | | | | | |
| | | $\Phi \leq 0.2\text{mm}$ | Ignore | | | | | | | | |
| | | $0.2\text{mm} < \Phi \leq 0.5\text{mm}$ | 3 | | | | | | | | |
| $\Phi > 0.5\text{mm}$ | Reject | | | | | | | | | | |
| 11.3.4.5 | Scratch on printing area | <table border="1"> <thead> <tr> <th>Size (mm)</th> <th>Acceptable Q'ty</th> </tr> </thead> <tbody> <tr> <td>$W \leq 0.03\text{mm}, L \leq 5\text{ mm}$</td> <td>Ignore</td> </tr> <tr> <td>$0.03\text{mm} < W \leq 0.05\text{mm}, L \leq 5\text{mm}$</td> <td>3</td> </tr> <tr> <td>$W > 0.05\text{mm}$ or $L > 5\text{mm}$</td> <td>Reject</td> </tr> </tbody> </table> | | Size (mm) | Acceptable Q'ty | $W \leq 0.03\text{mm}, L \leq 5\text{ mm}$ | Ignore | $0.03\text{mm} < W \leq 0.05\text{mm}, L \leq 5\text{mm}$ | 3 | $W > 0.05\text{mm}$ or $L > 5\text{mm}$ | Reject |
| | | Size (mm) | Acceptable Q'ty | | | | | | | | |
| | | $W \leq 0.03\text{mm}, L \leq 5\text{ mm}$ | Ignore | | | | | | | | |
| | | $0.03\text{mm} < W \leq 0.05\text{mm}, L \leq 5\text{mm}$ | 3 | | | | | | | | |
| $W > 0.05\text{mm}$ or $L > 5\text{mm}$ | Reject | | | | | | | | | | |
| 11.3.4.6 | Corner chipping |  | | | | | | | | | |
| | | <table border="1"> <thead> <tr> <th>Size(mm)</th> <th>Judgement</th> </tr> </thead> <tbody> <tr> <td> $X \leq 2\text{mm}, Y \leq 2\text{mm}$ $Z < 1/2 T$ (T= single glass thickness) </td> <td>Accept</td> </tr> </tbody> </table> | | Size(mm) | Judgement | $X \leq 2\text{mm}, Y \leq 2\text{mm}$ $Z < 1/2 T$ (T= single glass thickness) | Accept | | | | |
| | | Size(mm) | Judgement | | | | | | | | |
| $X \leq 2\text{mm}, Y \leq 2\text{mm}$ $Z < 1/2 T$ (T= single glass thickness) | Accept | | | | | | | | | | |
| | | | | | | | | | | | |
| 11.3.4.7 | Edge chipping |  | | | | | | | | | |
| | | <table border="1"> <thead> <tr> <th>Size(mm)</th> <th>Judgement</th> </tr> </thead> <tbody> <tr> <td> $X \leq 3\text{ mm}, Y \leq 3\text{ mm}$ $Z \leq 1/2 T$ (T= single glass thickness) </td> <td>Accept</td> </tr> </tbody> </table> | | Size(mm) | Judgement | $X \leq 3\text{ mm}, Y \leq 3\text{ mm}$ $Z \leq 1/2 T$ (T= single glass thickness) | Accept | | | | |
| | | Size(mm) | Judgement | | | | | | | | |
| $X \leq 3\text{ mm}, Y \leq 3\text{ mm}$ $Z \leq 1/2 T$ (T= single glass thickness) | Accept | | | | | | | | | | |
| | | | | | | | | | | | |

12. Handling Precautions

12.1 Mounting method

The LCD panel of AMSON TFT module consists of two thin glass plates with polarizers which easily be damaged. And since the module is so constructed as to be fixed by utilizing fitting holes in the printed circuit board.

Extreme care should be needed when handling the LCD modules.

12.2 Caution of LCD handling and cleaning

When cleaning the display surface, Use soft cloth with solvent

[Recommended below] and wipe lightly

- Isopropyl alcohol
- Ethyl alcohol

Do not wipe the display surface with dry or hard materials that will damage the polarizer surface.

Do not use the following solvent:

- Water
- Aromatics

Do not wipe ITO pad area with the dry or hard materials that will damage the ITO patterns

Do not use the following solvent on the pad or prevent it from being contaminated:

- Soldering flux
- Chlorine (Cl) , Sulfur (S)

If goods were sent without being silicon coated on the pad, ITO patterns could be damaged due to the corrosion as time goes on.

If ITO corrosion happens by miss-handling or using some materials such as Chlorine (Cl), Sulfur (S) from customer, Responsibility is on customer.

12.3 Caution against static charge

The LCD module uses C-MOS LSI drivers, so we recommend that you:

Connect any unused input terminal to VDD or GND, do not input any signals before power is turned on, and ground your body, work/assembly areas, and assembly equipment to protect against static electricity.

12.4 packing

- Module employs LCD elements and must be treated as such.
- Avoid intense shock and falls from a height.
- To prevent modules from degradation, do not operate or store them exposed direct to sunshine or high temperature/humidity

12.5 Caution for operation

- It is an indispensable condition to drive LCD's within the specified voltage limit since the higher voltage than the limit causes the shorter LCD life.
- An electrochemical reaction due to direct current causes LCD's undesirable deterioration, so that the use of direct current drive should be avoided.
- Response time will be extremely delayed at lower temperature than the operating temperature range and on the other hand at higher temperature LCD's show dark color in them. However those phenomena do not mean malfunction or out of order with LCD's, which will come back in the specified operation temperature.
- If the display area is pushed hard during operation, some font will be abnormally displayed but it resumes normal condition after turning off once.
- Slight dew depositing on terminals is a cause for electro-chemical reaction resulting in terminal open circuit.

Usage under the maximum operating temperature, 50%Rh or less is required.

12.6 storing

In the case of storing for a long period of time for instance, for years for the purpose or replacement use, the following ways are recommended.

- Storage in a polyethylene bag with the opening sealed so as not to enter fresh air outside in it. And with no desiccant.
- Placing in a dark place where neither exposure to direct sunlight nor light's keeping the storage temperature range.
- Storing with no touch on polarizer surface by the anything else.
[It is recommended to store them as they have been contained in the inner container at the time of delivery from us

12.7 Safety

- It is recommendable to crash damaged or unnecessary LCD's into pieces and wash off liquid crystal by either of solvents such as acetone and ethanol, which should be burned up later.
- When any liquid leaked out of a damaged glass cell comes in contact with your hands, please wash it off well with soap and water

13. Precaution for Use

13.1

A limit sample should be provided by the both parties on an occasion when the both parties agreed its necessity. Judgment by a limit sample shall take effect after the limit sample has been established and confirmed by the both parties.

13.2

On the following occasions, the handing of problem should be decided through discussion and agreement between responsible of the both parties.

- When a question is arisen in this specification
- When a new problem is arisen which is not specified in this specifications
- When an inspection specifications change or operating condition change in customer is reported to AMSON TFT , and some problem is arisen in this specification due to the change
- When a new problem is arisen at the customer's operating set for sample evaluation in the customer site.

14. Packing Method

TBD