

Specification for Approval

Customer: _____

Model Name: _____

Supplier Approval			Customer approval
R&D Designed	R&D Approved	QC Approved	
<i>Peter</i>	<i>Peng Jun</i>		

Revision Record

REV NO.	REV DATE	CONTENTS	Note
A	2017-11-22	NEW ISSUE	
B	2018-06-20	MODIFY B/L	
C	2018-12-25	CHANGING PACKAGING METHOD: UNDECIDED	
D	2019-01-02	CHANGING PACKAGING METHOD: UPDATE	
E	2019-02-25	LABEL(QR CODE)	

Table of Contents

List	Description	Page No.
	Cover	1
	Revision Record	2
	Table of Contents	3
1	Scope	4
2	General Information	4
3	External Dimensions	5
4	Interface Description	6
5	Absolute Maximum Ratings	7
6	DC Characteristics	7
7	Timing Characteristics	8
8	Backlight Characteristics	11
9	Optical Characteristics	12
10	Reliability Test Conditions and Methods	14
11	Inspection Standard	15
12	Handling Precautions	19
13	Precaution for Use	20
14	LABEL	21
15	Packing Method	22

1. Scope

This specification defines general provisions as well as inspection standards for TFT module supplied by AMSON electronics.

If the event of unforeseen problem or unspecified items may occur, naturally shall negotiate and agree to solution

2. General Information

ITEM	STANDARD VALUES	UNITS
LCD type	1.3" TFT	--
Dot arrangement	240(RGB)×240	dots
Color filter array	RGB vertical stripe	--
Display mode	IPS / Transmission / Normally Black	--
Viewing Direction	ALL	--
Driver IC	ST7789V	--
Module size	26.20(W)×29.22(H)×1.9(T)	mm
Active area	23.4(W)×23.4(H)	mm
Dot pitch	0.0975(W)×0.0975(H)	mm
Interface	8bit MCU / 4-wire SPI	--
Operating temperature	-20 ~ +70	°C
Storage temperature	-30 ~ +80	°C
Back Light	2 White LED In Parallel	--

4. Interface Description

Pin	Symbol	Description.
1	LEDA	LED backlight (Anode)
2	LEDK	LED backlight (Cathode)
3	GND	Power ground
4	VCC	Power supply for analog
5	IOVCC	Power supply for logic
6	IM1/2	IM1/2 signal selection;IM1/2= 0,8bit MCU mode; IM1/2 = 1,4Line SPI mode
7	RESET	Reset pin. Initializes the IC, when this signal is low Must be reset after power is stable
8	CS	Input pin for chip selection signal
9	DCX(SCL)	Display data/command selection pin in parallel interface This pin is used to be serial interface clock.
10	WR(D/CX)	Write enable pin I80 parallel bus system interface. Display data/command selection pin 4-wrie serial interface.
11	RD	Read enable pin I80 parallel bus system interface.
12	SDA	SPI data input
13-20	DB0-DB7	DATA BUS
21	TE	Tearing effect signal is used to synchronize MCU to frame memory
22	NC	Not connection
23-24	GND	Power ground

5. Absolute Maximum Ratings

Item	Symbol	Min.	Max.	Unit
Analog Supply Voltage	VCC	-0.3	4.6	V
Logic Supply Voltage	IOVCC	-0.3	4.6	V
Input Voltage	V _{in}	-0.3	VDD+0.3	V
Operating Temperature	T _{OP}	-20	70	°C
Storage Temperature	T _{ST}	-30	80	°C
Storage Humidity	HD	20	90	%RH

6. DC Characteristics

Item	Symbol	Min.	Typ.	Max.	Unit	Remark
Analog Supply Voltage	VCC	2.5	2.8	3.3	V	-
Logic Supply Voltage	IOVCC	1.65	1.8	3.3	V	
Input High Voltage	V _{IH}	0.7VDD	-	VDD	V	Digital input pins
Input Low Voltage	V _{IL}	GND	-	0.3VDD	V	Digital input pins
Output High Voltage	V _{OH}	0.8VDD	-	VDD	V	Digital output pins
Output Low Voltage	V _{OL}	GND	-	0.2VDD	V	Digital output pins
I/O Leak Current	I _{LI}	-0.1	-	0.1	uA	-
Supply Current	I _{CC}	-	8.5	11.05	mA	

7. Timing Characteristics

7.1 Reset Timing Characteristics

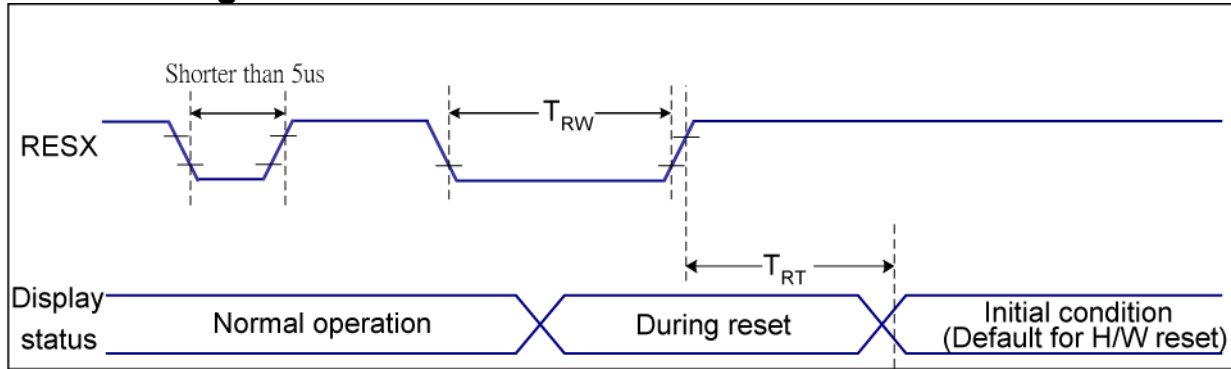

Related Pins	Symbol	Parameter	MIN	MAX	Unit
RESX	TRW	Reset pulse duration	10	-	us
	TRT	Reset cancel	-	5 (Note 1, 5)	ms
			120 (Note 1, 6, 7)	ms	

7.2 MCU Timing Characteristics

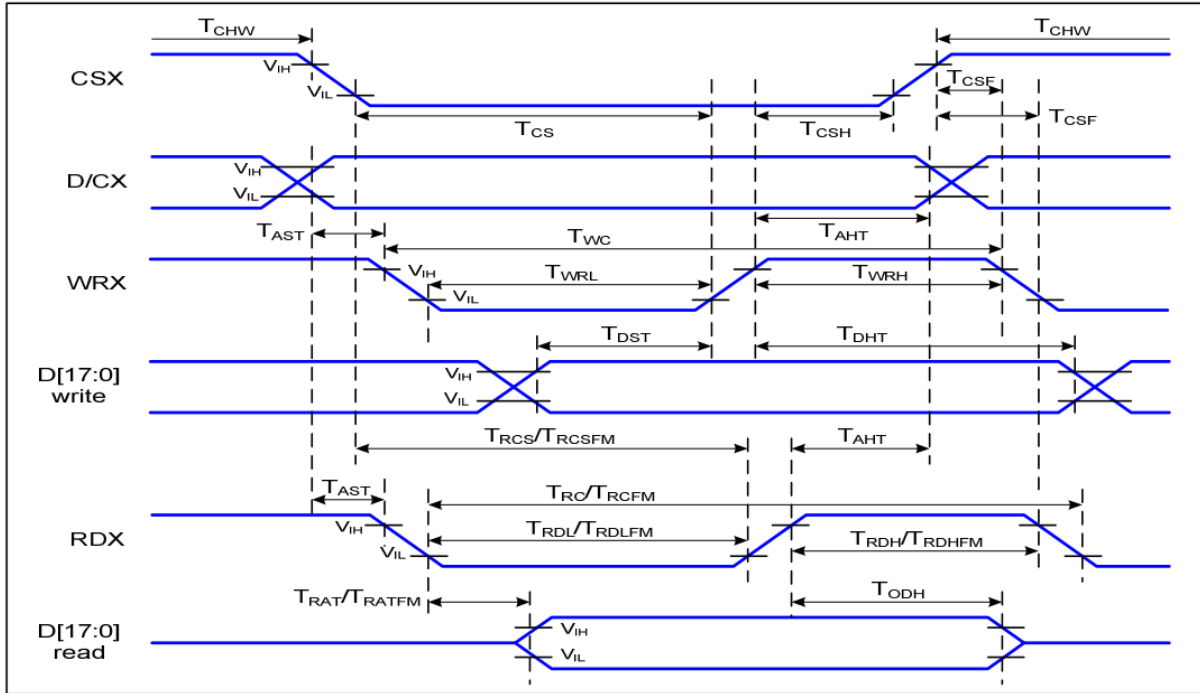

Signal	Symbol	Parameter	Min	Max	Unit	Description
D/CX	T_{AST}	Address setup time	0		ns	-
	T_{AHT}	Address hold time (Write/Read)	10		ns	
CSX	T_{CHW}	Chip select "H" pulse width	0		ns	-
	T_{CS}	Chip select setup time (Write)	15		ns	
	T_{RCS}	Chip select setup time (Read ID)	45		ns	
	T_{RCSFM}	Chip select setup time (Read FM)	355		ns	
	T_{CSF}	Chip select wait time (Write/Read)	10		ns	
	T_{CSH}	Chip select hold time	10		ns	
WRX	T_{WC}	Write cycle	66		ns	-
	T_{WRH}	Control pulse "H" duration	15		ns	
	T_{WRL}	Control pulse "L" duration	15		ns	
RDX (ID)	T_{RC}	Read cycle (ID)	160		ns	When read ID data
	T_{RDH}	Control pulse "H" duration (ID)	90		ns	
	T_{RDL}	Control pulse "L" duration (ID)	45		ns	
RDX (FM)	T_{RCFM}	Read cycle (FM)	450		ns	When read from frame memory
	T_{RDHFM}	Control pulse "H" duration (FM)	90		ns	
	T_{RDLFM}	Control pulse "L" duration (FM)	355		ns	
D[17:0]	T_{DST}	Data setup time	10		ns	For CL=30pF
	T_{DHT}	Data hold time	10		ns	
	T_{RAT}	Read access time (ID)		40	ns	
	T_{RATFM}	Read access time (FM)		340	ns	
	T_{ODH}	Output disable time	20	80	ns	

7.3 4-line SPI Timing Characteristics

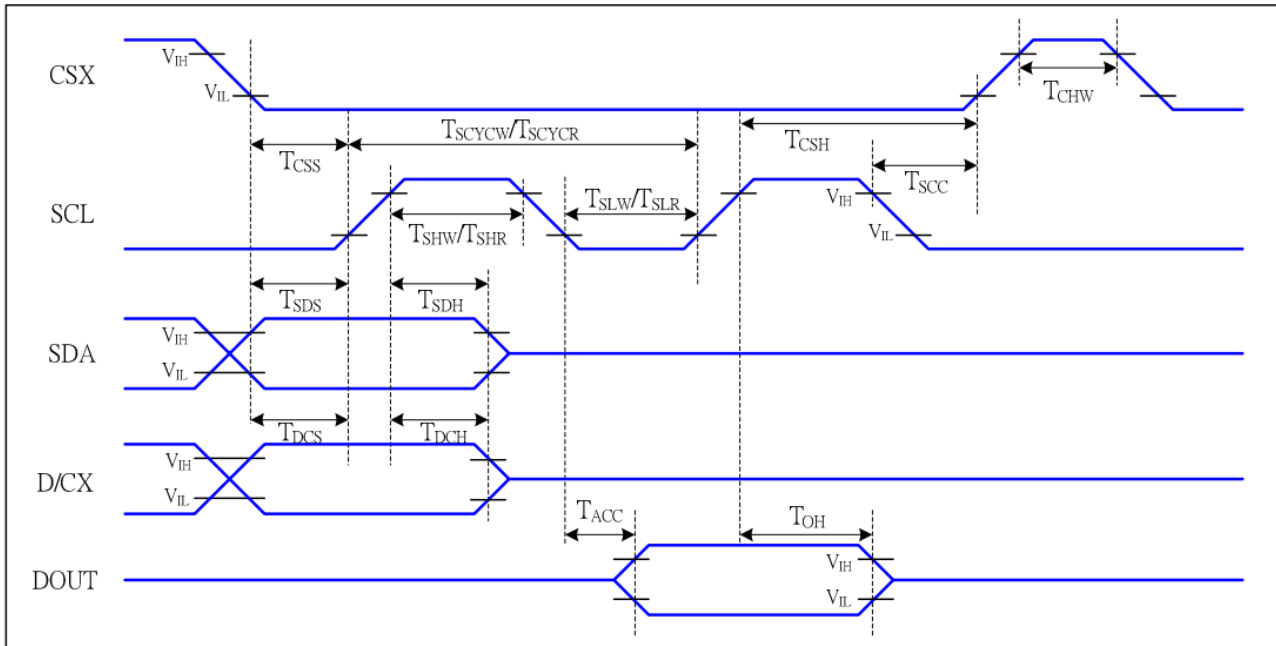

Signal	Symbol	Parameter	MIN	MAX	Unit	Description
CSX	T_{CSS}	Chip select setup time (write)	15		ns	
	T_{CSH}	Chip select hold time (write)	15		ns	
	T_{CSS}	Chip select setup time (read)	60		ns	
	T_{SCC}	Chip select hold time (read)	65		ns	
	T_{CHW}	Chip select "H" pulse width	40		ns	
SCL	T_{SCYCW}	Serial clock cycle (Write)	66		ns	-write command & data ram
	T_{SHW}	SCL "H" pulse width (Write)	15		ns	
	T_{SLW}	SCL "L" pulse width (Write)	15		ns	
	T_{SCYCR}	Serial clock cycle (Read)	150		ns	-read command & data ram
	T_{SHR}	SCL "H" pulse width (Read)	60		ns	
	T_{SLR}	SCL "L" pulse width (Read)	60		ns	
D/CX	T_{DCS}	D/CX setup time	10		ns	
	T_{DCH}	D/CX hold time	10		ns	
SDA (DIN)	T_{SDS}	Data setup time	10		ns	
	T_{SDH}	Data hold time	10		ns	
DOUT	T_{ACC}	Access time	10	50	ns	For maximum CL=30pF
	T_{OH}	Output disable time	15	50	ns	For minimum CL=8pF

8. Backlight Characteristic

LED Circuit:

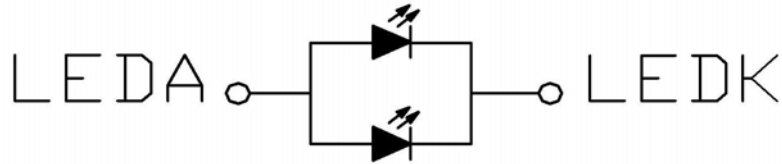

Item	Symbol	MIN	TYP	MAX	UNIT	Test Condition
Supply Voltage	Vf	2.9	3.2	3.5	V	If=40mA
Supply Current	If	-	40	-	mA	-
Luminous Intensity for LCM	-	300	350	-	Cd/m ²	If=40mA
Uniformity for LCM	-	80	-	-	%	If=40mA
Life Time	-	20000	-	-	Hr	If=40mA
Backlight Color	White					

9. Optical Characteristics

Item	Conditions	Min.	Typ.	Max.	Unit	Note	
Viewing Angle (CR>10)	Horizontal	θ_L	-	80	-	degree	(1),(2),(6)
		θ_R	-	80	-		
	Vertical	θ_T	-	80	-		
		θ_B	-	80	-		
Contrast Ratio	Center	640	800	-	-	(1),(3),(6)	
Response Time	Rising	-	30	35	ms	(1),(4),(6)	
	Falling						
CF Color Chromaticity (CIE1931)	Red x	Typ. -0.05	TBD	Typ. +0.05	-	(1), (6)	
	Red y		TBD		-		
	Green x		TBD		-		
	Green y		TBD		-		
	Blue x		TBD		-		
	Blue y		TBD		-		
	White x		TBD		-		
	White y		TBD		-		
Transmittance	-	-	4.65	-	%	(1),(5),(6)	

Note (1) Measurement Setup: The LCD module should be stabilized at given temp. 25°C for 15 minutes to avoid abrupt temperature change during measuring. In order to stabilize the luminance, the measurement should be executed after lighting backlight for 15 minutes in a windless room.

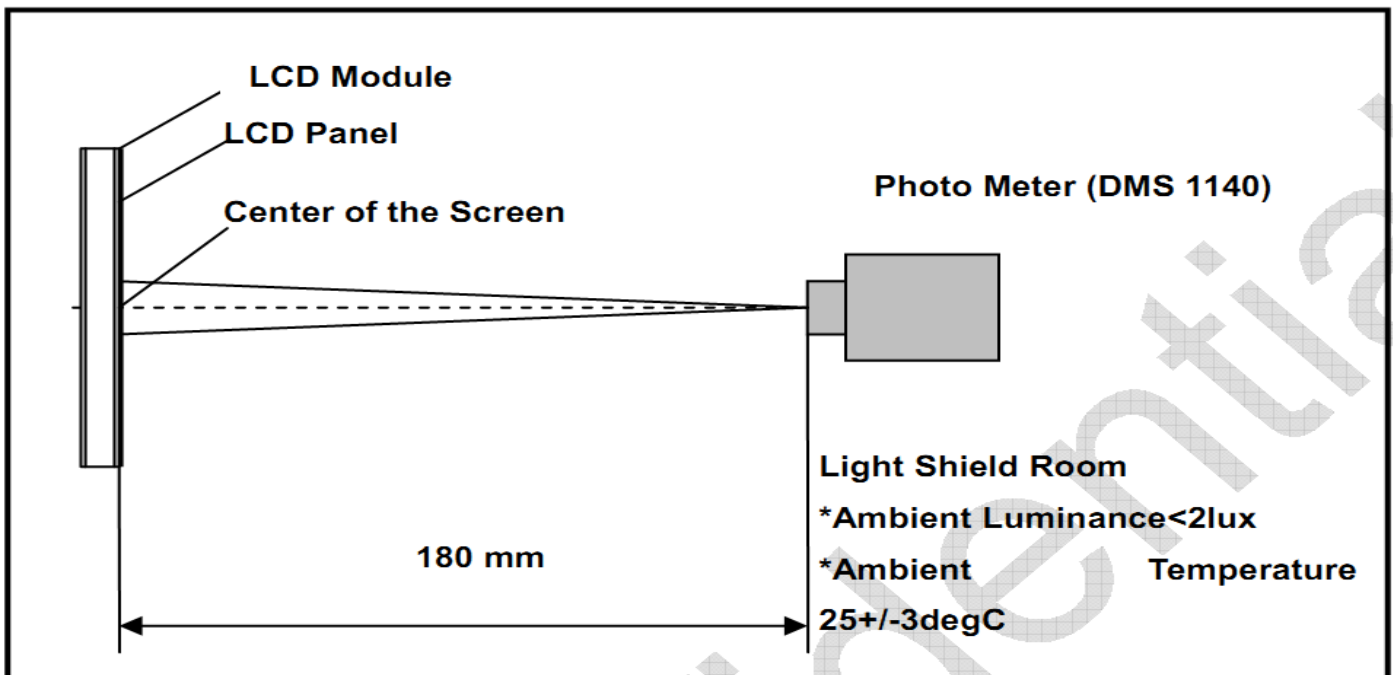

Note (2) Definition of Viewing Angle

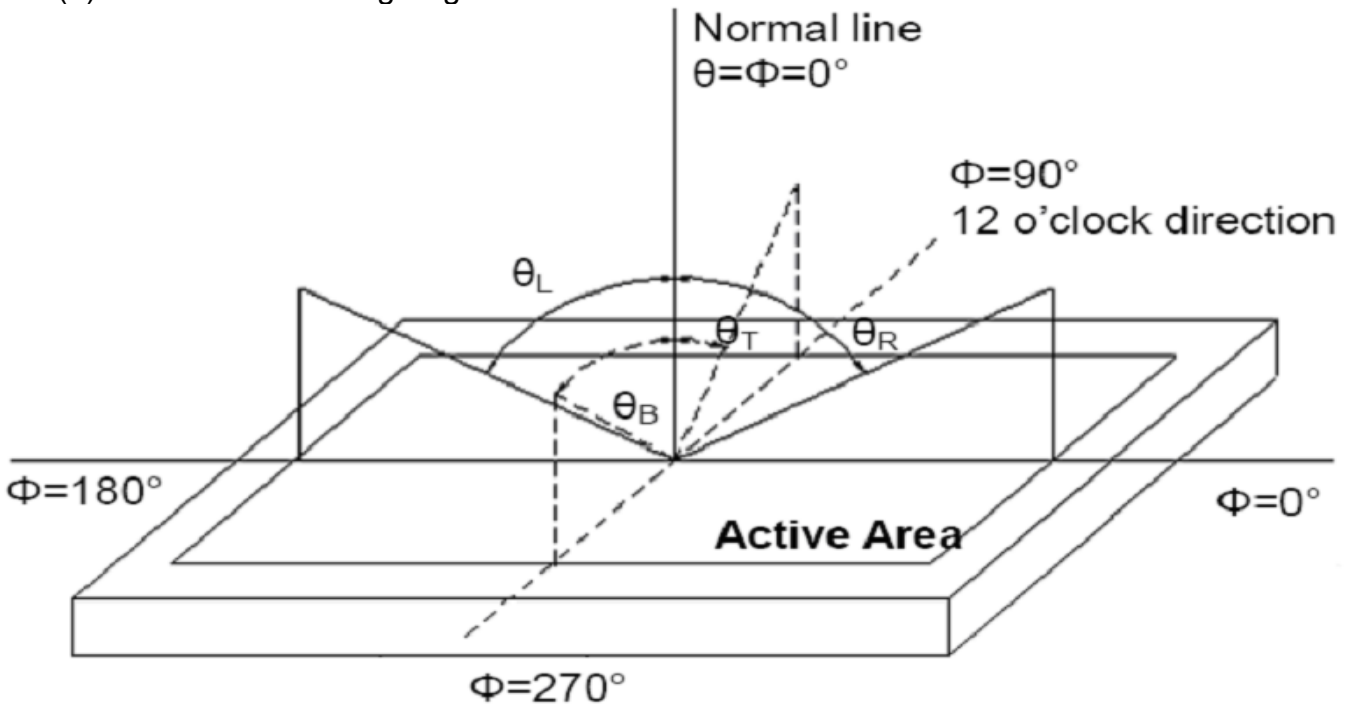

Note (3) Definition of Contrast Ratio (CR)

The contrast ratio can be calculated by the following expression

$$\text{Contrast Ratio (CR)} = L_{63} / L_0$$

L63: Luminance of gray level 63, L0: Luminance of gray level 0

Note (4) Definition of response time

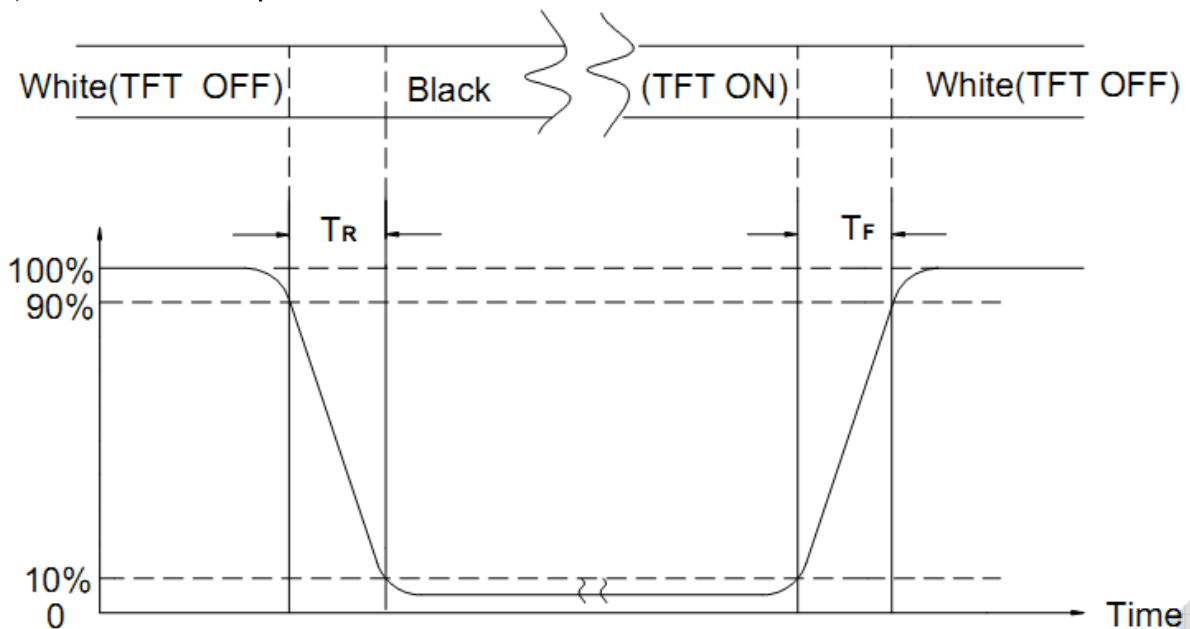

Note (5) Definition of Transmittance (Module is without signal input)

$$\text{Transmittance} = \text{Center Luminance of LCD} / \text{Center Luminance of Back Light} \times 100\%$$

Note (6) Definition of color chromaticity (CIE1931)

Color coordinates measured at the center point of LCD

10. Reliability Test Conditions And Methods

NO.	TEST ITEMS	TEST CONDITION	INSPECTION AFTER TEST
①	High Temperature Storage	80°C±2°C×96Hours	Inspection after 2~4hours storage at room temperature, the samples should be free from defects: 1, Air bubble in the LCD. 2, Seal leak. 3, Non-display. 4, Missing segments. 5, Glass crack. 6, Current IDD is twice higher than initial value. 7, The surface shall be free from damage. 8, The electric characteristic requirements shall be satisfied.
②	Low Temperature Storage	-30°C±2°C×96Hours	
③	High Temperature Operating	70°C±2°C×96Hours	
④	Low Temperature Operating	-20°C±2°C×96Hours	
⑤	Temperature Cycle(Storage)	$ \begin{array}{ccccc} -20^{\circ}\text{C} & \longleftrightarrow & 25^{\circ}\text{C} & \longleftrightarrow & 70^{\circ}\text{C} \\ (30\text{min}) & & (5\text{min}) & & (30\text{min}) \\ & \longleftarrow & & \longrightarrow & \\ & & \text{1cycle} & & \\ & & \text{Total 10cycle} & & \end{array} $	
⑥	Damp Proof Test (Storage)	50°C±5°C×90%RH×120Hours	
⑦	Vibration Test	Frequency:10Hz~55Hz~10Hz Amplitude:1.5MM X,Y,Z direction for total 3hours (packing condition test will be tested by a carton)	
⑧	Drooping Test	Drop to the ground from 1M height one time every side of carton. (packing condition test will be tested by a carton)	
⑨	ESD Test	Voltage:±8KV,R:330Ω,C:150PF,Air Mode,10times	

REMARK:

- 1, The Test samples should be applied to only one test item.
- 2, Sample side for each test item is 5~10pcs.
- 3, For Damp Proof Test, Pure water(Resistance > 10MΩ) should be used.
- 4, In case of malfunction defect caused by ESD damage, if it would be recovered to normal state after resetting, it would be judge as a good part.
- 5, EL evaluation should be accepted from reliability test with humidity and temperature: Some defects such as black spot/blemish can happen by natural chemical reaction with humidity and Fluorescence EL has.
- 6, Failure Judgment Criterion: Basic Specification Electrical Characteristic, Mechanical Characteristic, Optical Characteristic.

11. Inspection Standard

11.1 Incoming Inspection and Standard:

The below incoming inspection are applied to the TFT LCM Modules supplied by AMSON Optoelectronic Industry CO.,LTD. The customers should inspect the LCM within 14 days after receiving the goods. The result of inspection should be notified to the Seller in the writing copy promptly, if the customer do not send them within 14 days, the seller has the right to judge as acceptance of goods. The inspection lot size is treated as the quantity per shipment and per model. The sampling plan shall be inspected under MIL-STD015E in Level II by single sampling. The acceptable quality level (AQL) are categorized as below grades:

CRITICAL= 0.65%, MAJOR= 0.65%, MINOR= 1.5%

11.2 Inspection condition and Warranty policy:

The delivered LCM should be stored properly, ideally under climate-controlled environment at 25 (±5) degree Celsius as well as 60% (±10) Relative Humidity. The LCM shall be inspected in the viewing angle of 45 degree from the four major angles (U/D/L/R) under the single fluorescent lamp of 20W (equal to 300 to 500 lux). For warranty, AMSON Optoelectronic Industry CO.,LTD. will provide 12 months of warranty period as standard, and provide the new replacement for the defective products which belong to the Seller's responsibility verified by the quality department.

11.3 Inspection Criteria:

11.3.1 Critical defect (重度缺失)

Item No.	Inspection content	Judgement
11.3.1.1	Functional defects	No display, abnormal display, short circuit, missing line, off-contrast and chromaticity, Touch Panel non-function
11.3.1.2	Model mixed	Other model mixed

11.3.2 Major defect: (主要缺失)

Item No.	Inspection content	Judgement
11.3.2.1	Product indication	Missing model no. and wrong model no. is indicated on the LCM.
11.3.2.2	Glass cracking	The LCD and touch panel glass crack or breakage
11.3.2.3	Missing component	The function component missing such as connector, cable, etc.

11.3.3 Minor defect (LCD) : (次要缺失)

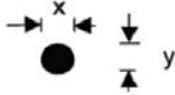
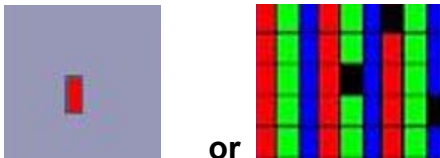
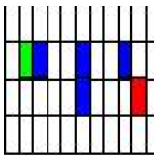
Item No.	Inspection content	Judgement												
11.3.3.1	Black/White spot Foreign particles Dust in the cell	$\phi = (x+y) / 2$  <table border="1"> <thead> <tr> <th>Diameter (mm)</th> <th>Acceptable Q'ty</th> </tr> </thead> <tbody> <tr> <td>$\Phi \leq 0.1$</td> <td>Ignore</td> </tr> <tr> <td>$0.1 < \Phi \leq 0.25$</td> <td>3 (Distance>5mm)</td> </tr> <tr> <td>$0.25 < \Phi$</td> <td>Not allowed</td> </tr> </tbody> </table>	Diameter (mm)	Acceptable Q'ty	$\Phi \leq 0.1$	Ignore	$0.1 < \Phi \leq 0.25$	3 (Distance>5mm)	$0.25 < \Phi$	Not allowed				
Diameter (mm)	Acceptable Q'ty													
$\Phi \leq 0.1$	Ignore													
$0.1 < \Phi \leq 0.25$	3 (Distance>5mm)													
$0.25 < \Phi$	Not allowed													
11.3.3.2	Linear defect Black/white line Black/white scratch	<table border="1"> <thead> <tr> <th>Length(mm)</th> <th>Width (mm)</th> <th>Acceptable Q'ty</th> </tr> </thead> <tbody> <tr> <td></td> <td>$W \leq 0.03$</td> <td>Ignore</td> </tr> <tr> <td>$L \leq 5.0$</td> <td>$0.03 < W \leq 0.07$</td> <td>3</td> </tr> <tr> <td></td> <td>$0.07 < W$</td> <td>Follow 11.3.3.1</td> </tr> </tbody> </table>	Length(mm)	Width (mm)	Acceptable Q'ty		$W \leq 0.03$	Ignore	$L \leq 5.0$	$0.03 < W \leq 0.07$	3		$0.07 < W$	Follow 11.3.3.1
Length(mm)	Width (mm)	Acceptable Q'ty												
	$W \leq 0.03$	Ignore												
$L \leq 5.0$	$0.03 < W \leq 0.07$	3												
	$0.07 < W$	Follow 11.3.3.1												
11.3.3.3	Polarizer Bubbles Dent on polarizer	<table border="1"> <thead> <tr> <th>Diameter (mm)</th> <th>Acceptable Q'ty</th> </tr> </thead> <tbody> <tr> <td>$\Phi \leq 0.2$</td> <td>Ignore</td> </tr> <tr> <td>$0.2 < \Phi \leq 0.5$</td> <td>2 (Distance>5mm)</td> </tr> <tr> <td>$0.5 < \Phi$</td> <td>Not allowed</td> </tr> </tbody> </table>	Diameter (mm)	Acceptable Q'ty	$\Phi \leq 0.2$	Ignore	$0.2 < \Phi \leq 0.5$	2 (Distance>5mm)	$0.5 < \Phi$	Not allowed				
Diameter (mm)	Acceptable Q'ty													
$\Phi \leq 0.2$	Ignore													
$0.2 < \Phi \leq 0.5$	2 (Distance>5mm)													
$0.5 < \Phi$	Not allowed													
11.3.3.4	Electrical defect Dot	<p>Bright dot and Dark dot definition:</p>  <p>or</p>  <p>(Two adjacent dot)</p> <p>Inspection pattern: black, white, red, green, and blue screen.</p> <table border="1"> <thead> <tr> <th>Items</th> <th>Acceptable Q'ty</th> </tr> </thead> <tbody> <tr> <td>Bright dot</td> <td>$N \leq 4$ (Distance >5mm)</td> </tr> <tr> <td>Dark dot</td> <td>$N \leq 4$ (Distance >5mm)</td> </tr> </tbody> </table>	Items	Acceptable Q'ty	Bright dot	$N \leq 4$ (Distance >5mm)	Dark dot	$N \leq 4$ (Distance >5mm)						
Items	Acceptable Q'ty													
Bright dot	$N \leq 4$ (Distance >5mm)													
Dark dot	$N \leq 4$ (Distance >5mm)													

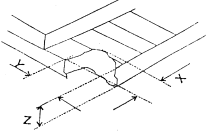
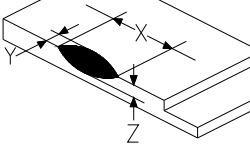
11.3.3.5	Glass Defect- Corner chipping	 <table border="1" data-bbox="703 389 1410 667"> <thead> <tr> <th>Size(mm)</th> <th>Judgement</th> </tr> </thead> <tbody> <tr> <td> $X \leq 3\text{mm}, Y \leq S,$ $Z \leq T$ (S= ITO length, T=Single glass thickness) </td> <td>Accept</td> </tr> </tbody> </table>	Size(mm)	Judgement	$X \leq 3\text{mm}, Y \leq S,$ $Z \leq T$ (S= ITO length, T=Single glass thickness)	Accept
Size(mm)	Judgement					
$X \leq 3\text{mm}, Y \leq S,$ $Z \leq T$ (S= ITO length, T=Single glass thickness)	Accept					
11.3.3.6	Glass Defect- Side fragment	 <table border="1" data-bbox="703 864 1410 1077"> <thead> <tr> <th>Size(mm)</th> <th>Judgement</th> </tr> </thead> <tbody> <tr> <td> $X \leq 2 \text{ mm}, Y \leq \text{border edge}$ $Z \leq T$ (T= single glass thickness) </td> <td>Accept</td> </tr> </tbody> </table>	Size(mm)	Judgement	$X \leq 2 \text{ mm}, Y \leq \text{border edge}$ $Z \leq T$ (T= single glass thickness)	Accept
Size(mm)	Judgement					
$X \leq 2 \text{ mm}, Y \leq \text{border edge}$ $Z \leq T$ (T= single glass thickness)	Accept					

11.3.4 Minor defect (Touch Panel)

Item No.	Inspection content	Judgement								
11.3.4.1	Scratch, dust, particles, foreign materials in “linear type”	<table border="1" data-bbox="703 1397 1410 1666"> <thead> <tr> <th>Size (mm)</th> <th>Acceptable Q'ty</th> </tr> </thead> <tbody> <tr> <td>$W \leq 0.05\text{mm}, L \leq 10\text{mm}$</td> <td>Ignore</td> </tr> <tr> <td>$0.05\text{mm} < W \leq 0.07\text{mm}, L \leq 10\text{mm}$</td> <td>3</td> </tr> <tr> <td>$W > 0.07\text{mm}$</td> <td>Reject</td> </tr> </tbody> </table>	Size (mm)	Acceptable Q'ty	$W \leq 0.05\text{mm}, L \leq 10\text{mm}$	Ignore	$0.05\text{mm} < W \leq 0.07\text{mm}, L \leq 10\text{mm}$	3	$W > 0.07\text{mm}$	Reject
Size (mm)	Acceptable Q'ty									
$W \leq 0.05\text{mm}, L \leq 10\text{mm}$	Ignore									
$0.05\text{mm} < W \leq 0.07\text{mm}, L \leq 10\text{mm}$	3									
$W > 0.07\text{mm}$	Reject									
11.3.4.2	Scratch, dust, particles, foreign materials in “round type”	<table border="1" data-bbox="703 1738 1410 1973"> <thead> <tr> <th>Diameter (mm)</th> <th>Acceptable Q'ty</th> </tr> </thead> <tbody> <tr> <td>$\Phi \leq 0.25\text{mm}$</td> <td>Ignore</td> </tr> <tr> <td>$0.25\text{mm} < \Phi \leq 0.35\text{mm}$</td> <td>5</td> </tr> <tr> <td>$\Phi > 0.35\text{mm}$</td> <td>Reject</td> </tr> </tbody> </table>	Diameter (mm)	Acceptable Q'ty	$\Phi \leq 0.25\text{mm}$	Ignore	$0.25\text{mm} < \Phi \leq 0.35\text{mm}$	5	$\Phi > 0.35\text{mm}$	Reject
Diameter (mm)	Acceptable Q'ty									
$\Phi \leq 0.25\text{mm}$	Ignore									
$0.25\text{mm} < \Phi \leq 0.35\text{mm}$	5									
$\Phi > 0.35\text{mm}$	Reject									

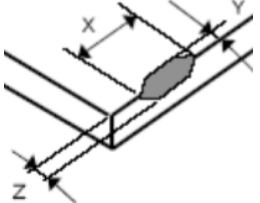
11.3.4.3	Air bubbles	<table border="1" style="width: 100%; border-collapse: collapse; text-align: center;"> <tr> <th style="width: 50%;">Diameter (mm)</th> <th style="width: 50%;">Acceptable Q'ty</th> </tr> <tr> <td>$\Phi \leq 0.2\text{mm}$</td> <td>Ignore</td> </tr> <tr> <td>$0.2\text{mm} < \Phi \leq 0.5\text{mm}$</td> <td>3</td> </tr> <tr> <td>$\Phi > 0.5\text{mm}$</td> <td>Reject</td> </tr> </table>	Diameter (mm)	Acceptable Q'ty	$\Phi \leq 0.2\text{mm}$	Ignore	$0.2\text{mm} < \Phi \leq 0.5\text{mm}$	3	$\Phi > 0.5\text{mm}$	Reject
Diameter (mm)	Acceptable Q'ty									
$\Phi \leq 0.2\text{mm}$	Ignore									
$0.2\text{mm} < \Phi \leq 0.5\text{mm}$	3									
$\Phi > 0.5\text{mm}$	Reject									
11.3.4.5	Scratch on printing area	<table border="1" style="width: 100%; border-collapse: collapse; text-align: center;"> <tr> <th style="width: 50%;">Size (mm)</th> <th style="width: 50%;">Acceptable Q'ty</th> </tr> <tr> <td>$W \leq 0.03\text{mm}, L \leq 5\text{ mm}$</td> <td>Ignore</td> </tr> <tr> <td>$0.03\text{mm} < W \leq 0.05\text{mm}, L \leq 5\text{mm}$</td> <td>3</td> </tr> <tr> <td>$W > 0.05\text{mm}$ or $L > 5\text{mm}$</td> <td>Reject</td> </tr> </table>	Size (mm)	Acceptable Q'ty	$W \leq 0.03\text{mm}, L \leq 5\text{ mm}$	Ignore	$0.03\text{mm} < W \leq 0.05\text{mm}, L \leq 5\text{mm}$	3	$W > 0.05\text{mm}$ or $L > 5\text{mm}$	Reject
Size (mm)	Acceptable Q'ty									
$W \leq 0.03\text{mm}, L \leq 5\text{ mm}$	Ignore									
$0.03\text{mm} < W \leq 0.05\text{mm}, L \leq 5\text{mm}$	3									
$W > 0.05\text{mm}$ or $L > 5\text{mm}$	Reject									
11.3.4.6	Corner chipping	<div style="text-align: center;">  </div> <table border="1" style="width: 100%; border-collapse: collapse; text-align: center;"> <tr> <th style="width: 50%;">Size(mm)</th> <th style="width: 50%;">Judgement</th> </tr> <tr> <td> $X \leq 2\text{mm}, Y \leq 2\text{mm}$ $Z < 1/2 T$ (T= single glass thickness) </td> <td>Accept</td> </tr> </table>	Size(mm)	Judgement	$X \leq 2\text{mm}, Y \leq 2\text{mm}$ $Z < 1/2 T$ (T= single glass thickness)	Accept				
Size(mm)	Judgement									
$X \leq 2\text{mm}, Y \leq 2\text{mm}$ $Z < 1/2 T$ (T= single glass thickness)	Accept									
11.3.4.7	Edge chipping	<div style="text-align: center;">  </div> <table border="1" style="width: 100%; border-collapse: collapse; text-align: center;"> <tr> <th style="width: 50%;">Size(mm)</th> <th style="width: 50%;">Judgement</th> </tr> <tr> <td> $X \leq 3\text{ mm}, Y \leq 3\text{ mm}$ $Z \leq 1/2 T$ (T= single glass thickness) </td> <td>Accept</td> </tr> </table>	Size(mm)	Judgement	$X \leq 3\text{ mm}, Y \leq 3\text{ mm}$ $Z \leq 1/2 T$ (T= single glass thickness)	Accept				
Size(mm)	Judgement									
$X \leq 3\text{ mm}, Y \leq 3\text{ mm}$ $Z \leq 1/2 T$ (T= single glass thickness)	Accept									

12. Handling Precautions

12.1 Mounting method

The LCD panel of AMSON TFT module consists of two thin glass plates with polarizers which easily be damaged. And since the module is so constructed as to be fixed by utilizing fitting holes in the printed circuit board.

Extreme care should be needed when handling the LCD modules.

12.2 Caution of LCD handling and cleaning

When cleaning the display surface, Use soft cloth with solvent

[Recommended below] and wipe lightly

- Isopropyl alcohol
- Ethyl alcohol

Do not wipe the display surface with dry or hard materials that will damage the polarizer surface.

Do not use the following solvent:

- Water
- Aromatics

Do not wipe ITO pad area with the dry or hard materials that will damage the ITO patterns

Do not use the following solvent on the pad or prevent it from being contaminated:

- Soldering flux
- Chlorine (Cl) , Sulfur (S)

If goods were sent without being silicon coated on the pad, ITO patterns could be damaged due to the corrosion as time goes on.

If ITO corrosion happens by miss-handling or using some materials such as Chlorine (Cl), Sulfur (S) from customer, Responsibility is on customer.

12.3 Caution against static charge

The LCD module uses C-MOS LSI drivers, so we recommend that you:

Connect any unused input terminal to POWER or GROUND, do not input any signals before power is turned on, and ground your body, work/assembly areas, and assembly equipment to protect against static electricity.

12.4 packing

- Module employs LCD elements and must be treated as such.
- Avoid intense shock and falls from a height.
- To prevent modules from degradation, do not operate or store them exposed direct to sunshine or high temperature/humidity

12.5 Caution for operation

- It is an indispensable condition to drive LCD's within the specified voltage limit since the higher voltage than the limit causes the shorter LCD life.
- An electrochemical reaction due to direct current causes LCD's undesirable deterioration, so that the use of direct current drive should be avoided.
- Response time will be extremely delayed at lower temperature than the operating temperature range and on the other hand at higher temperature LCD's show dark color in them. However those phenomena do not mean malfunction or out of order with LCD's, which will come back in the specified operation temperature.
- If the display area is pushed hard during operation, some font will be abnormally displayed but it resumes normal condition after turning off once.
- Slight dew depositing on terminals is a cause for electro-chemical reaction resulting in terminal open circuit.

Usage under the maximum operating temperature, 50%Rh or less is required.

12.6 storing

In the case of storing for a long period of time for instance, for years for the purpose or replacement use, the following ways are recommended.

- Storage in a polyethylene bag with the opening sealed so as not to enter fresh air outside in it . And with no desiccant.
- Placing in a dark place where neither exposure to direct sunlight nor light's keeping the storage temperature range.
- Storing with no touch on polarizer surface by the anything else.
[It is recommended to store them as they have been contained in the inner container at the time of delivery from us

12.7 Safety

- It is recommendable to crash damaged or unnecessary LCD's into pieces and wash off liquid crystal by either of solvents such as acetone and ethanol, which should be burned up later.
- When any liquid leaked out of a damaged glass cell comes in contact with your hands, please wash it off well with soap and water

13. Precaution for Use

13.1

A limit sample should be provided by the both parties on an occasion when the both parties agreed its necessity. Judgment by a limit sample shall take effect after the limit sample has been established and confirmed by the both parties.

13.2

On the following occasions, the handing of problem should be decided through discussion and agreement between responsible of the both parties.

- When a question is arisen in this specification.
- When a new problem is arisen which is not specified in this specifications?
- When an inspection specifications change or operating condition change in customer is reported to AMSON TFT and some problem is arisen in this specification due to the change.
- When a new problem is arisen at the customer's operating set for sample evaluation in the customer site.

14. LABEL:

14.1 Label: QR CODE tag

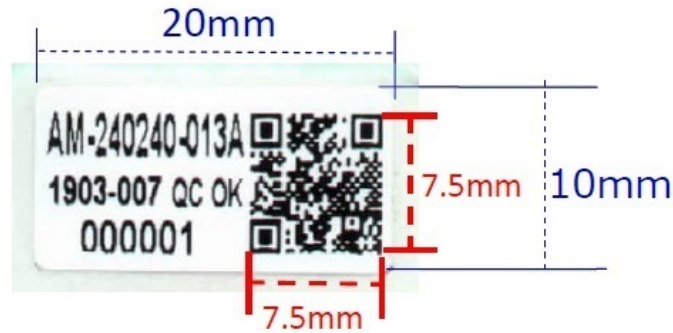

Label size : 20 x 10 mm
 QR Code size: 7.5 x 7.5 mm
 QR Code Marking:

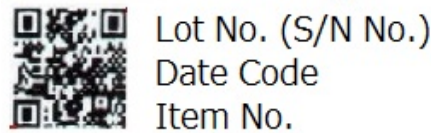

14.2 Label the bottom left of each PC

