

Specification for Approval

Customer: _____

Model Name: _____

| Supplier Approval | | | Customer approval |
|-------------------|-----------------|-------------|-------------------|
| R&D Designed | R&D Approved | QC Approved | |
| <i>Peter</i> | <i>Peng Jun</i> | | |

Table of Contents

| List | Description | Page No. |
|------|---|----------|
| | Cover | 1 |
| | Revision Record | 2 |
| | Table of Contents | 3 |
| 1 | Scope | 4 |
| 2 | General Information | 4 |
| 3 | External Dimensions | 5 |
| 4 | Interface Description | 6 |
| 5 | Absolute Maximum Ratings | 7 |
| 6 | Electrical Characteristics | 7 |
| 7 | Timing Characteristics | 8 |
| 8 | Backlight Characteristics | 13 |
| 9 | Optical Characteristics | 14 |
| 10 | Reliability Test Conditions and Methods | 16 |
| 11 | Inspection Standard | 17 |
| 12 | Handling Precautions | 20 |
| 13 | Precaution for Use | 21 |
| 14 | Packing Method | 22 |

1. Scope

This specification defines general provisions as well as inspection standards for TFT module supplied by AMSON electronics.

If the event of unforeseen problem or unspecified items may occur, naturally shall negotiate and agree to solution.

2. General Information

| ITEM | STANDARD VALUES | UNITS |
|-----------------------|---|-------|
| LCD type | 3.5" TFT | -- |
| Dot arrangement | 320(RGB) × 240 | dots |
| Color filter array | RGB vertical stripe | -- |
| Display mode | TN / Transmissive / Normally White | -- |
| Viewing Direction | 6 o'clock (Gray scale inversion) | -- |
| Driver IC | HX8238-D | -- |
| Module size | 76.9(W) × 63.9(H) × 3.3(T) | mm |
| Active area | 70.08(W) × 52.56(H) | mm |
| Dot pitch | 0.219(W) × 0.219(H) | mm |
| Interface | 24 bits RGB with Serial Interface / CCIR656 | -- |
| Operating temperature | -20 ~ +70 | °C |
| Storage temperature | -30 ~ +80 | °C |
| Back Light | 6 White LED | -- |
| Weight | TBD | g |

4. Interface Description

| PIN NO. | PIN NAME | DESCRIPTION |
|---------|----------|--|
| 1 | LEDK | LED backlight cathode |
| 2 | LEDK | LED backlight cathode |
| 3 | LEDA | LED backlight anode |
| 4 | LEDA | LED backlight anode |
| 5 | NC | No Connection |
| 6 | /RESET | System Reset |
| 7 | NC | No Connection |
| 8 | NC | No Connection |
| 9 | NC | No Connection |
| 10 | NC | No Connection |
| 11 | NC | No Connection |
| 12 | DB0 | RGB Data Bus |
| 13 | DB1 | |
| 14 | DB2 | |
| 15 | DB3 | |
| 16 | DB4 | |
| 17 | DB5 | |
| 18 | DB6 | |
| 19 | DB7 | |
| 20 | DG0 | |
| 21 | DG1 | |
| 22 | DG2 | |
| 23 | DG3 | |
| 24 | DG4 | |
| 25 | DG5 | |
| 26 | DG6 | |
| 27 | DG7 | |
| 28 | DR0 | |
| 29 | DR1 | |
| 30 | DR2 | |
| 31 | DR3 | |
| 32 | DR4 | |
| 33 | DR5 | |
| 34 | DR6 | |
| 35 | DR7 | |
| 36 | HSYNC | Line synchronizing signal for RGB interface operation |
| 37 | VSYNC | Frame synchronizing signal for RGB interface operation |
| 38 | DOTCLK | Dot Clock |
| 39 | NC | No Connection. |

| | | |
|----|-------|------------------------------------|
| 40 | NC | No Connection. |
| 41 | VCC | Power supply. |
| 42 | VCC | Power supply. |
| 43 | SPENA | SPI ENABLE |
| 44 | NC | No Connection. |
| 45 | NC | No Connection. |
| 46 | NC | No Connection. |
| 47 | NC | No Connection. |
| 48 | NC | No Connection. |
| 49 | SPCLK | SERIAL CLOCK SIGNAL |
| 50 | SPDAT | SERIAL DATA SIGNAL |
| 51 | NC | No Connection. |
| 52 | DEN | Display enable pin from controller |
| 53 | GND | Power ground |
| 54 | GND | Power ground |

5. Absolute Maximum Ratings

| Item | Symbol | Min. | Max. | Unit |
|-----------------------|-----------------|---------|------|------|
| Supply Voltage | VCC | -0.3 | 4.0 | V |
| Input Voltage | V _{in} | GND-0.3 | 4.0 | V |
| Operating Temperature | T _{OP} | -20 | 70 | °C |
| Storage Temperature | T _{ST} | -30 | 80 | °C |
| Storage Humidity | HD | -- | 90 | %RH |

6. DC Characteristics

| Item | Symbol | Min. | Typ. | Max. | Unit | Remark |
|---------------------|----------------------------------|---------|------|---------|------|---------------------|
| Supply Voltage | VCC | 2.5 | -- | 3.6 | V | -- |
| Input High Voltage | V _{IH} | 0.8 VCC | -- | VCC | V | Digital input pins |
| Input Low Voltage | V _{IL} | 0 | -- | 0.2 VCC | V | Digital input pins |
| Output High Voltage | V _{OH} | 0.9 VCC | -- | VCC | V | Digital output pins |
| Output Low Voltage | V _{OL} | 0 | -- | 0.1 VCC | V | Digital output pins |
| Logic Input Current | I _{IL} /I _{IH} | -1 | -- | 1 | uA | -- |

7. Timing Characteristics

7.1 Pixel Timing Characteristics

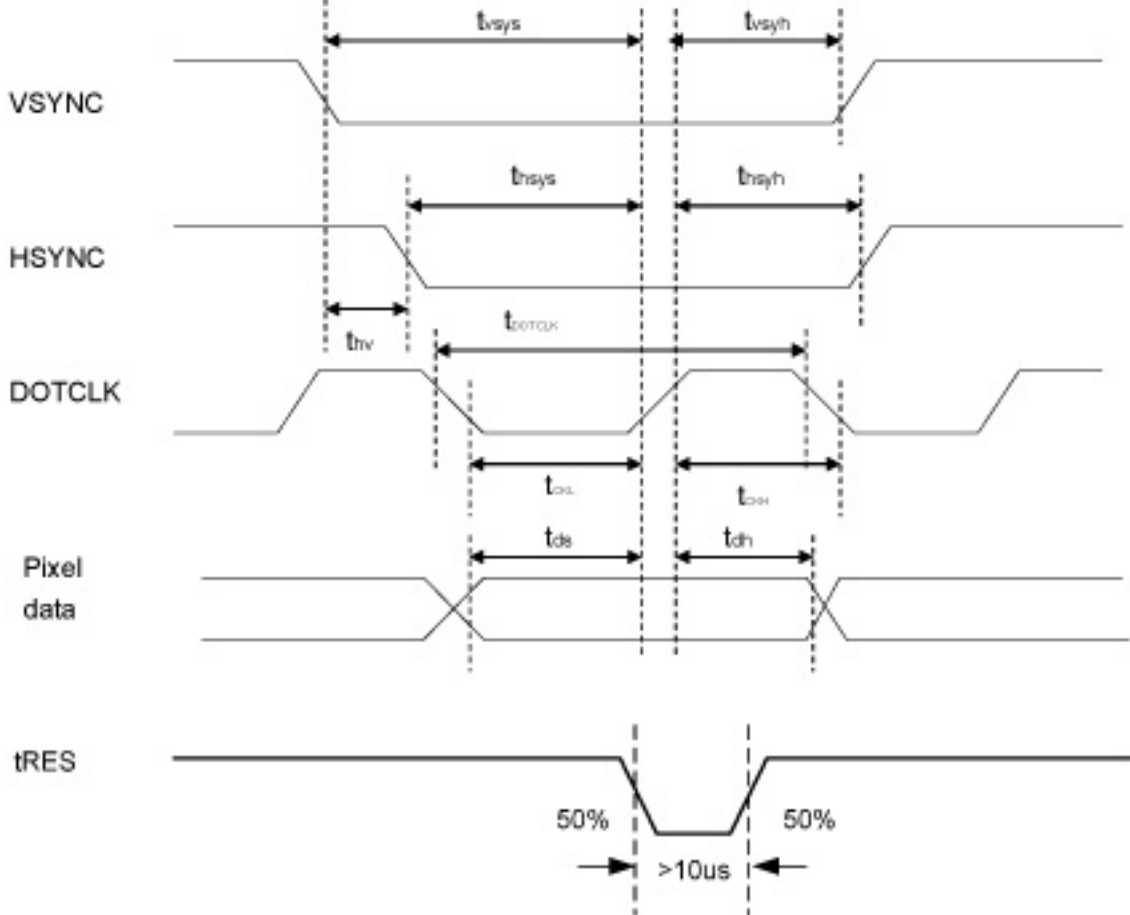

Figure 7. 1 Pixel Timing

| Characteristics | Symbol | Min. | | Typ. | | Max. | | Unit |
|--|---------|--------|-------|--------|-------|--------|-------|---------|
| | | 24 bit | 8 bit | 24 bit | 8 bit | 24 bit | 8 bit | |
| DOTCLK Frequency | fDOTCLK | - | - | 6.5 | 19.5 | 10 | 30 | MHz |
| DOTCLK Period | tDOTCLK | 100 | 33.3 | 154 | 51.3 | - | - | ns |
| Vertical Sync Setup Time | tvsys | 20 | 10 | - | - | - | - | ns |
| Vertical Sync Hold Time | tvsyh | 20 | 10 | - | - | - | - | ns |
| Horizontal Sync Setup Time | thsys | 20 | 10 | - | - | - | - | ns |
| Horizontal Sync Hold Time | thsyh | 20 | 10 | - | - | - | - | ns |
| Phase difference of Sync Signal Falling Edge | thv | 1 | | - | | 240 | | tDOTCLK |
| DOTCLK Low Period | tCKL | 50 | 15 | - | - | - | - | ns |
| DOTCLK High Period | tCKH | 50 | 15 | - | - | - | - | ns |
| Data Setup Time | tds | 12 | 10 | - | - | - | - | ns |
| Data hold Time | tdh | 12 | 10 | - | - | - | - | ns |
| Reset pulse width | tRES | 10 | | - | | - | | μs |

Note: External clock source must be provided to DOTCLK pin of HX8238-D. The driver will not operate if absent of the clocking signal.

Table 7. 1 Pixel Timing

7.2 RGB Interface Timing Characteristics

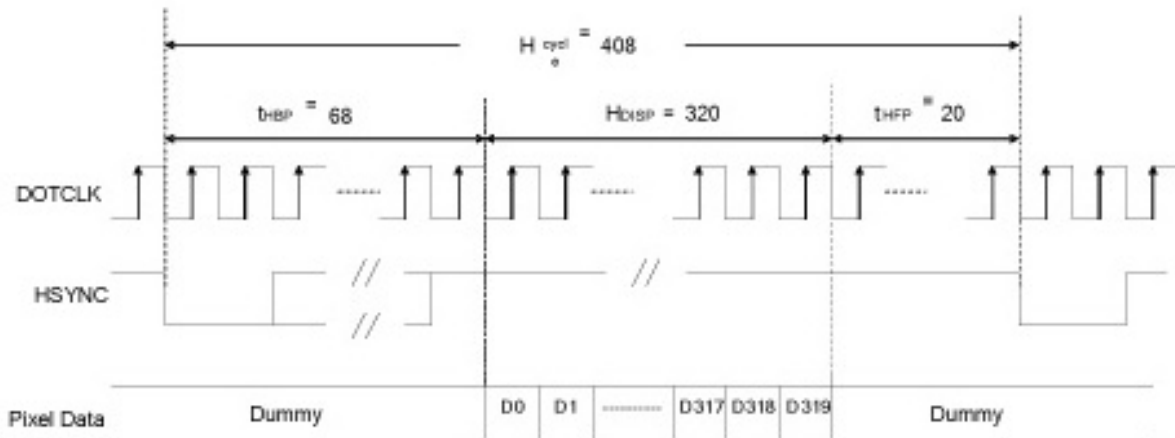

(a) Horizontal Data Transaction Timing

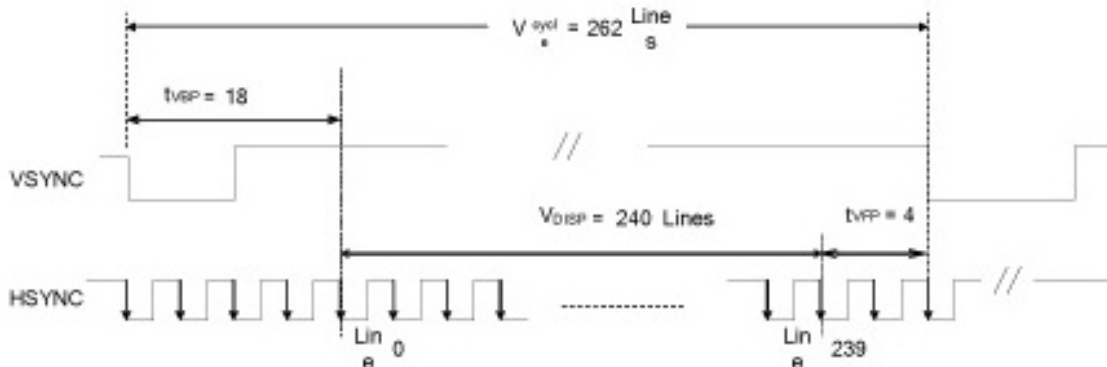

(b) Vertical Data Transaction Timing

Figure 7. 2 Data Transaction Timing in Parallel RGB (24 bit) Interface (SYNC Mode)

| Characteristics | Symbol | Min. | | Typ. | | Max. | | Unit |
|------------------------------|-------------|--------|-------|-------------|-------|--------|-------|---------|
| | | 24 bit | 8 bit | 24 bit | 8 bit | 24 bit | 8 bit | |
| DOTCLK Frequency | fDOTCLK | - | - | 6.5 | 19.5 | 10 | 30 | MHz |
| DOTCLK Period | tDOTCLK | 100 | 33.3 | 154 | 51.3 | - | - | ns |
| Horizontal Frequency (Line) | fH | - | - | 14.9 | - | 22.35 | - | KHz |
| Vertical Frequency (Refresh) | fV | - | - | 60 | - | 90 | - | Hz |
| Horizontal Back Porch | tHBP | - | - | 68 | 204 | - | - | tDOTCLK |
| Horizontal Front Porch | tHFP | - | - | 20 | 60 | - | - | tDOTCLK |
| Horizontal Data Start Point | tHBP | - | - | 68 | 204 | - | - | tDOTCLK |
| Horizontal Blanking Period | tHBP + tHFP | - | - | 88 | 264 | - | - | tDOTCLK |
| Horizontal Display Area | HDISP | - | - | 320 | 960 | - | - | tDOTCLK |
| Horizontal Cycle | Hcycle | - | - | 408 | 1224 | 450 | 1350 | tDOTCLK |
| Vertical Back Porch | tVBP | - | - | 18 | - | - | - | Lines |
| Vertical Front Porch | tVFP | - | - | 4 | - | - | - | Lines |
| Vertical Data Start Point | tVBP | - | - | 18 | - | - | - | Lines |
| Vertical Blanking Period | tVBP + tVFP | - | - | 22 | - | - | - | Lines |
| Vertical Display Area | NTSC | - | - | 240 | | - | - | Lines |
| | PAL | | | 280(PALM=0) | | | | |
| | PAL | | | 288(PALM=1) | | | | |
| Vertical Cycle | NTSC | - | - | 262 | | 350 | - | Lines |
| | PAL | | | 313 | | | | |

Table 7. 2 Data Transaction Timing in Normal Operating Mode

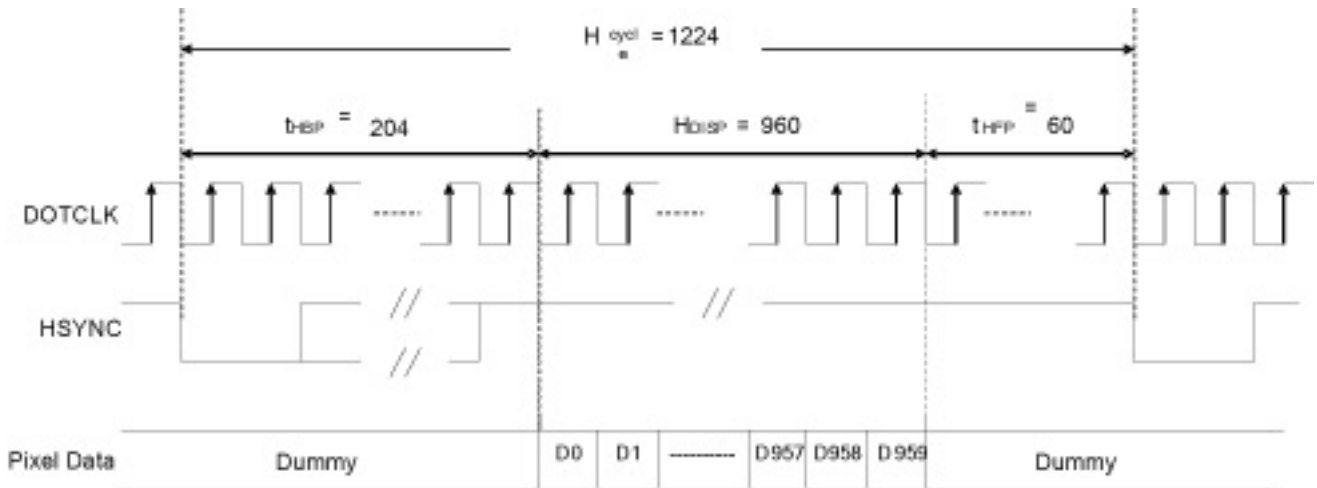

(1) Horizontal Data Transaction Timing

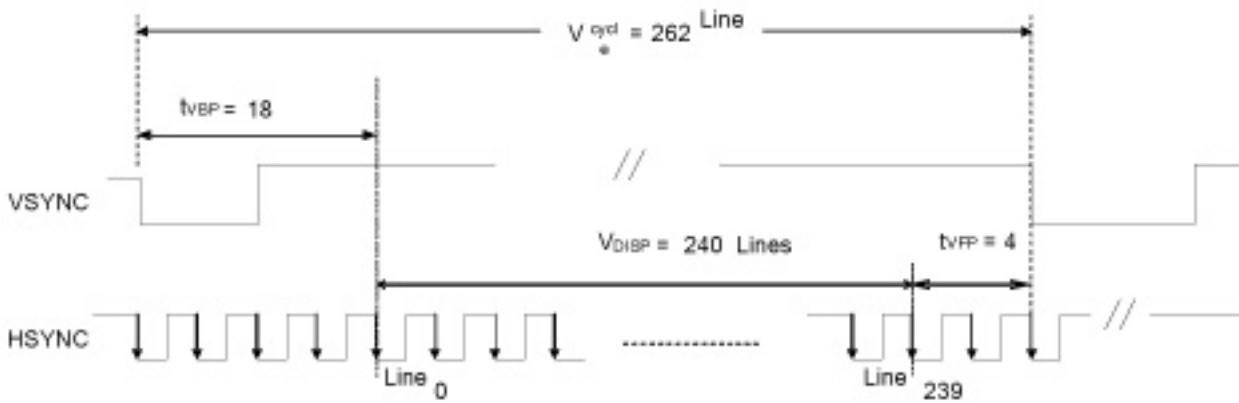

(2) Vertical Data Transaction Timing

Figure 7. 3 Data Transaction Timing in Serial RGB (8 bit) Interface (SYNC Mode)

7.3 CCIR656 Timing Characteristics

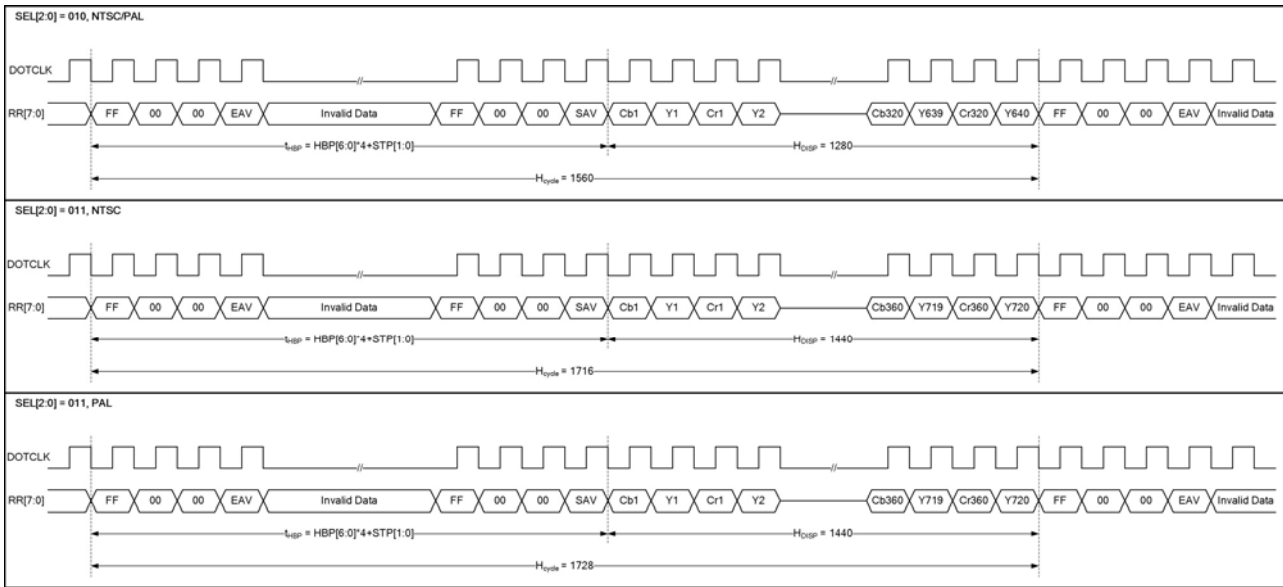

Figur 7.4 CCIR656 Horizontal Timing

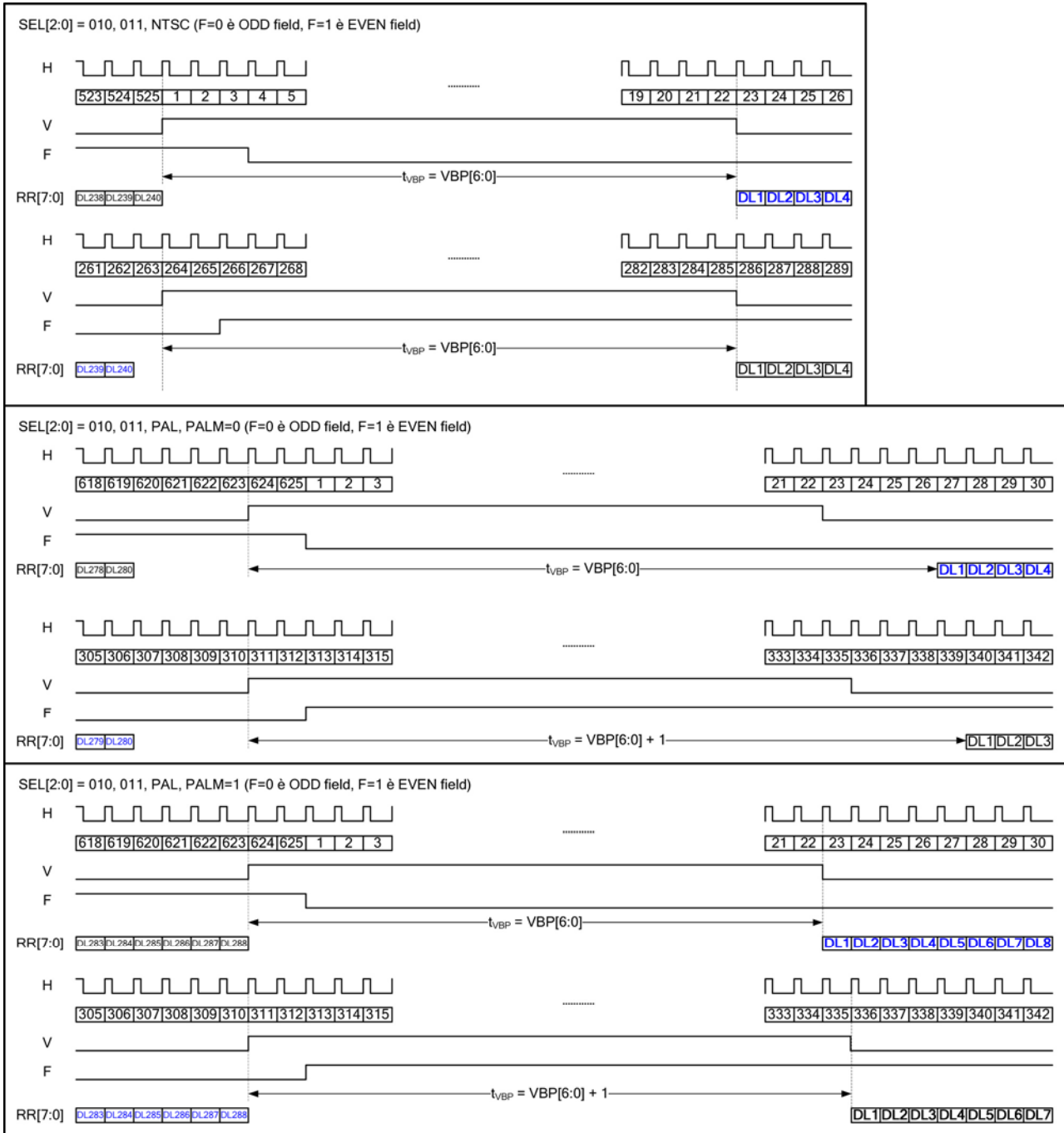
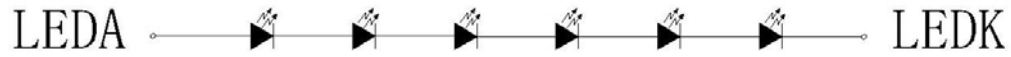

Figure 7.5 CCIR656 Vertical Timing

8. Backlight Characteristics

BL Circuit Diagram:



| Item | Symbol | MIN | TYP | MAX | UNIT | Test Condition |
|----------------------------|--------|-------|------|-----|-------------------|----------------|
| Supply Voltage | Vf | 18 | 19.2 | 20 | V | If=15mA |
| Supply Current | If | -- | 15 | -- | mA | -- |
| Luminous Intensity for LCM | -- | 480 | 550 | -- | Cd/m ² | If=15mA |
| Uniformity for LCM | -- | 80 | -- | -- | % | If=15mA |
| Life Time | -- | 50000 | -- | -- | Hr | If=15mA |
| Backlight Color | White | | | | | |

9. Optical Characteristics

(Note1 · Note2) (Using Normal Polarizer +CPT Backlight, reference only)

| ITEM | SYMBOL | CONDITION | MIN. | TYP. | MAX. | UNIT | REMARK | |
|---------------------------|--------|------------------------------|------------------------------|-------|-------|-------------------|--------|--------|
| Brightness | BL | $\theta = \varphi = 0^\circ$ | 480 | 550 | -- | cd/m ² | Note2 | |
| Contrast Ratio | CR | $\theta = \varphi = 0^\circ$ | 150 | 250 | -- | -- | Note3 | |
| Response Time | Tr+ Tf | $\theta = \varphi = 0^\circ$ | -- | 50 | 70 | ms | Note4 | |
| Viewing Angle | Upper | θ | CR \geq 10 | -- | 45 | -- | -- | Note 5 |
| | Down | | | -- | 45 | -- | -- | |
| | Right | φ | | -- | 35 | -- | -- | |
| | Left | | | -- | 15 | -- | -- | |
| Color Filter Chromaticity | White | X y | $\theta = \varphi = 0^\circ$ | 0.264 | 0.294 | 0.324 | -- | Note 6 |
| | | | | 0.304 | 0.334 | 0.364 | -- | |
| | Red | X y | $\theta = \varphi = 0^\circ$ | 0.603 | 0.633 | 0.663 | -- | |
| | | | | 0.296 | 0.326 | 0.356 | -- | |
| | Green | X y | $\theta = \varphi = 0^\circ$ | 0.267 | 0.297 | 0.327 | -- | |
| | | | | 0.547 | 0.577 | 0.607 | -- | |
| | Blue | X y | $\theta = \varphi = 0^\circ$ | 0.103 | 0.133 | 0.163 | -- | |
| | | | | 0.099 | 0.129 | 0.159 | -- | |

Note1: Definition of Operation Voltage (Vop)

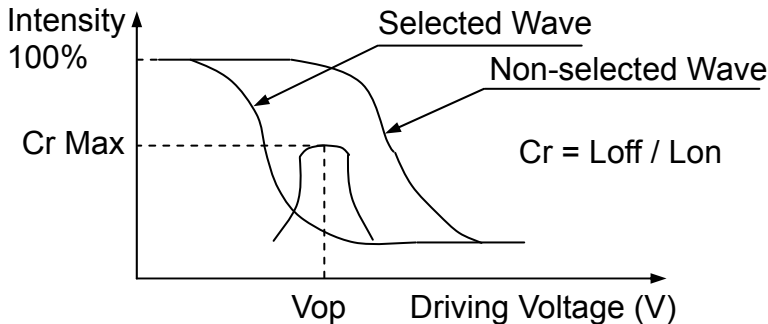

Note2: Definition of Luminance Uniformity : $L = L(\text{MIN}) / L(\text{MAX}) \times 100\%$

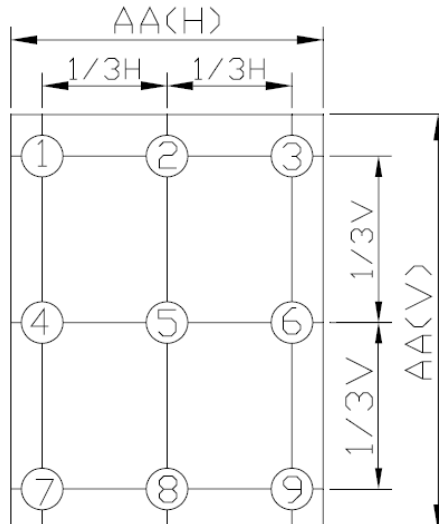

Note 3. Definition of Contrast Ratio:

$$CR = \text{White Luminance (ON)} / \text{Black Luminance (OFF)}$$

Note 4. Definition of response time : The response time is defined as the time interval between the 10% and 90% amplitudes.

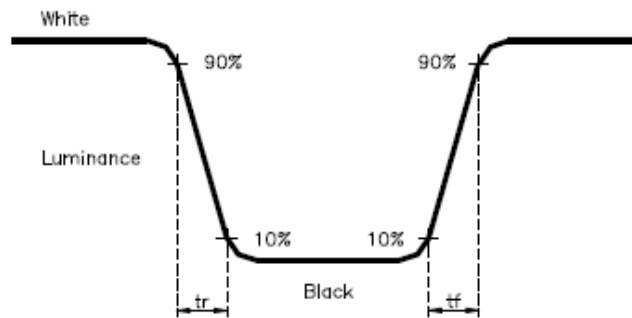

Note 5. Definition of view angle(θ , ψ) :

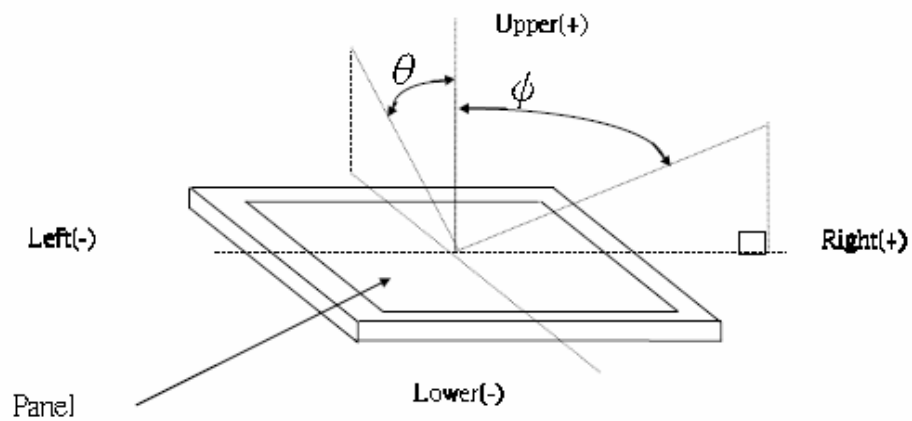

Note 6. Light source: C light.

10. Reliability Test Conditions and Methods

| NO. | TEST ITEMS | TEST CONDITION | INSPECTION AFTER TEST |
|--|----------------------------|---|---|
| <input type="checkbox"/> | High Temperature Storage | 80°C±2°C×200Hours | Inspection after 2~4hours storage at room temperature, the samples should be free from defects: 1, Air bubble in the LCD. 2, Seal leak. 3, Non-display. 4, Missing segments. 5, Glass crack. 6, Current IDD is twice higher than initial value. 7, The surface shall be free from damage. 8, The electric characteristic requirements shall be satisfied. |
| <input type="checkbox"/> | Low Temperature Storage | -30°C±2°C×200Hours | |
| <input type="checkbox"/> | High Temperature Operating | 70°C±2°C×120Hours | |
| <input type="checkbox"/> | Low Temperature Operating | -20°C±2°C×120Hours | |
| <input type="checkbox"/> | Temperature Cycle(Storage) | -20°C ↔ 25°C ↔ 70°C (30min) ← (5min) → (30min) 1cycle Total 10cycle | |
| <input type="checkbox"/> | Damp Proof Test (Storage) | 50°C±5°C×90%RH×120Hours | |
| <input type="checkbox"/> | Vibration Test | Frequency:10Hz~55Hz~10Hz Amplitude:1.5M X,Y,Z direction for total 3hours (Packing Condition) | |
| <input type="checkbox"/> | Drooping Test | Drop to the ground from 1M height one time every side of carton. (Packing Condition) | |
| <input type="checkbox"/> | ESD Test | Voltage:±8KV,R:330Ω,C:150PF,Air Mode,10times | |
| REMARK: 1, The Test samples should be applied to only one test item. 2, Sample side for each test item is 5~10pcs. 3,For Damp Proof Test, Pure water(Resistance > 10MΩ)should be used. 4,In case of malfunction defect caused by ESD damage, if it would be recovered to normal state after resetting, it would be judge as a good part. 5, EL evaluation should be accepted from reliability test with humidity and temperature: Some defects such as black spot/blemish can happen by natural chemical reaction with humidity and Fluorescence EL has. 6, Failure Judgment Criterion: Basic Specification Electrical Characteristic, Mechanical Characteristic, Optical Characteristic. | | | |

11. Inspection Standard

This standard apply to C-STN/TFT module

1. Spot check plan:

According to spot check level II ,MIL-STD-105D Level II ,the rank of accept or reject is below:

3A、 2A : major non-conformance : AQL 0.25 minor non-conformance : AQL 0.4

1A : major non-conformance : AQL 0.65 minor non-conformance : AQL 1.

2. Inspection condition:

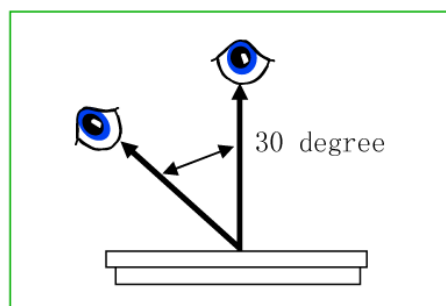

Under daylight lamp 20~40W, product distance inspector 'eye 30cm,incline degree 30°.

3. LCD area define:

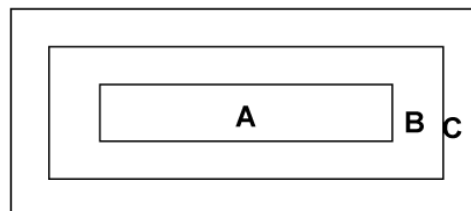

Area A: display area

Area B: VA area

Area C: out of VA area, not in sight after assembly

Remark: non-conformance at area C, but is OK that isn't influence reliability of product & assembly by customer.

4. Inspection standard

4.1 Major non-conformance

| NO. | Item | Inspection standard | Rate |
|-------|--------------------------|--|--------------|
| 4.1.1 | Function non-conformance | 1) No display, display abnormally 2) Miss line, short 3) B/L no function or function abnormally 4) TP no function | major |
| 4.1.2 | miss | No matter miss what component | |
| 4.1.3 | Out of size | Module dimension out of spec | |

4.2 Appearance non-conformance

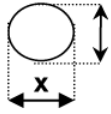
| NO. | Item | Inspection standard | Rate | | | | | | | | | | | | | | | | | | | | | | | | | | | | | | |
|-------------------------|--------------------------------|---|----------|-------------------|-------------------|--|--|-----------|----------|---|------------------|--------|--------|---------------|-------------------------|---|--|--------------|-------------------------|---|--|--|-------------------------|----------------------|---|--|---------------|---|------------|--------------------------------|--|--|-------|
| 4.2.1 | Black or white spot (power on) | dot non-conformance define Φ <div style="display: flex; align-items: center; justify-content: center; margin-top: 10px;"> $\Phi = \frac{+y}{2} \times x$  </div> | Minor | | | | | | | | | | | | | | | | | | | | | | | | | | | | | | |
| | | A grade <table border="1" style="width: 100%; border-collapse: collapse; margin-top: 10px;"> <thead> <tr> <th rowspan="2" style="width: 30%;">area size (mm)</th> <th colspan="3" style="text-align: center;">Most approve q'ty</th> </tr> <tr> <th style="width: 15%;">A</th> <th style="width: 15%;">B</th> <th style="width: 15%;">C</th> </tr> </thead> <tbody> <tr> <td>$\Phi \leq 0.10$</td> <td colspan="3" style="text-align: center;">ignore</td> </tr> <tr> <td>$0.10 < \Phi \leq 0.15$</td> <td colspan="3" style="text-align: center;">4</td> </tr> <tr> <td>$0.15 < \Phi \leq 0.20$</td> <td colspan="3" style="text-align: center;">2</td> </tr> <tr> <td>$0.20 < \Phi \leq 0.25$</td> <td colspan="3" style="text-align: center;">1</td> </tr> <tr> <td>$0.25 < \Phi$</td> <td colspan="3" style="text-align: center;">0</td> </tr> </tbody> </table> <p style="margin-top: 10px;">Most approve 4 damages, dot to dot $\geq 10\text{mm}$</p> | | area size (mm) | Most approve q'ty | | | A | B | C | $\Phi \leq 0.10$ | ignore | | | $0.10 < \Phi \leq 0.15$ | 4 | | | $0.15 < \Phi \leq 0.20$ | 2 | | | $0.20 < \Phi \leq 0.25$ | 1 | | | $0.25 < \Phi$ | 0 | | | | | |
| area size (mm) | Most approve q'ty | | | | | | | | | | | | | | | | | | | | | | | | | | | | | | | | |
| | A | B | C | | | | | | | | | | | | | | | | | | | | | | | | | | | | | | |
| $\Phi \leq 0.10$ | ignore | | | | | | | | | | | | | | | | | | | | | | | | | | | | | | | | |
| $0.10 < \Phi \leq 0.15$ | 4 | | | | | | | | | | | | | | | | | | | | | | | | | | | | | | | | |
| $0.15 < \Phi \leq 0.20$ | 2 | | | | | | | | | | | | | | | | | | | | | | | | | | | | | | | | |
| $0.20 < \Phi \leq 0.25$ | 1 | | | | | | | | | | | | | | | | | | | | | | | | | | | | | | | | |
| $0.25 < \Phi$ | 0 | | | | | | | | | | | | | | | | | | | | | | | | | | | | | | | | |
| 4.2.2 | Black or white line (power on) | A grade <table border="1" style="width: 100%; border-collapse: collapse; margin-top: 10px;"> <thead> <tr> <th colspan="2" style="text-align: center;">Size(mm)</th> <th colspan="3" style="text-align: center;">Most approve q'ty</th> </tr> <tr> <th style="width: 20%;">L(length)</th> <th style="width: 20%;">W(width)</th> <th style="width: 15%;">A</th> <th style="width: 15%;">B</th> <th style="width: 15%;">C</th> </tr> </thead> <tbody> <tr> <td>ignore</td> <td>$W \leq 0.03$</td> <td colspan="3" style="text-align: center;">ignore</td> </tr> <tr> <td>$L \leq 5.0$</td> <td>$0.03 < W \leq 0.05$</td> <td colspan="3" style="text-align: center;">3</td> </tr> <tr> <td>$L \leq 3.0$</td> <td>$0.05 < W \leq 0.07$</td> <td colspan="3" style="text-align: center;">2</td> </tr> <tr> <td></td> <td>$0.07 < W$</td> <td colspan="3" style="text-align: center;">Treat with dot non-conformance</td> </tr> </tbody> </table> <p style="margin-top: 10px;">Most approve 3 damages, line to line $\geq 10\text{mm}$</p> | Size(mm) | | Most approve q'ty | | | L(length) | W(width) | A | B | C | ignore | $W \leq 0.03$ | ignore | | | $L \leq 5.0$ | $0.03 < W \leq 0.05$ | 3 | | | $L \leq 3.0$ | $0.05 < W \leq 0.07$ | 2 | | | | $0.07 < W$ | Treat with dot non-conformance | | | Minor |
| Size(mm) | | Most approve q'ty | | | | | | | | | | | | | | | | | | | | | | | | | | | | | | | |
| L(length) | W(width) | A | B | C | | | | | | | | | | | | | | | | | | | | | | | | | | | | | |
| ignore | $W \leq 0.03$ | ignore | | | | | | | | | | | | | | | | | | | | | | | | | | | | | | | |
| $L \leq 5.0$ | $0.03 < W \leq 0.05$ | 3 | | | | | | | | | | | | | | | | | | | | | | | | | | | | | | | |
| $L \leq 3.0$ | $0.05 < W \leq 0.07$ | 2 | | | | | | | | | | | | | | | | | | | | | | | | | | | | | | | |
| | $0.07 < W$ | Treat with dot non-conformance | | | | | | | | | | | | | | | | | | | | | | | | | | | | | | | |

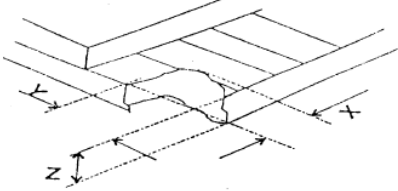
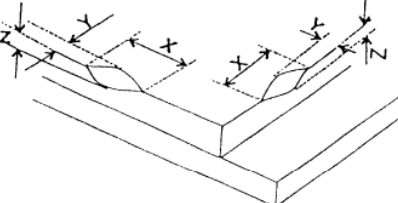
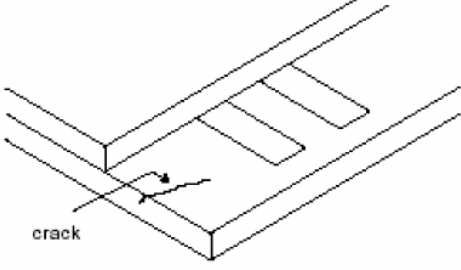
| 4.2.3 | Polarizer position | 1) Polarizer attach meet drawing, disallow out of LCD. 2) Polarizer must cover display area (special require unless) | Minor | | | | | | | | | | | | |
|-------|-----------------------|--|-------|---|---|------|----|--------|---|---|---|------|-------------|--------|-------|
| 4.2.4 | LCD non-conformance | <p>(i) crash at side (remark: S=ITO length)</p>  <table border="1" data-bbox="609 674 1179 788"> <thead> <tr> <th>X</th> <th>Y</th> <th>Z</th> </tr> </thead> <tbody> <tr> <td>≤3.0</td> <td>≤S</td> <td>ignore</td> </tr> </tbody> </table> <p>Crash disallow extend to ITO or seal.</p> <p>(ii) commonly surface scathe</p>  <table border="1" data-bbox="590 1133 1198 1247"> <thead> <tr> <th>X</th> <th>Y</th> <th>Z</th> </tr> </thead> <tbody> <tr> <td>≤2.0</td> <td><frame edge</td> <td>ignore</td> </tr> </tbody> </table> <p>(iii) crack</p> <p>Disallow extend crack</p>  | X | Y | Z | ≤3.0 | ≤S | ignore | X | Y | Z | ≤2.0 | <frame edge | ignore | Minor |
| X | Y | Z | | | | | | | | | | | | | |
| ≤3.0 | ≤S | ignore | | | | | | | | | | | | | |
| X | Y | Z | | | | | | | | | | | | | |
| ≤2.0 | <frame edge | ignore | | | | | | | | | | | | | |
| 4.2.5 | Contrast voltage warp | VOP/Vlcd voltage of confirmed sample ±0.15V | Minor | | | | | | | | | | | | |
| 4.2.6 | color | Color & luminance of module scope reference spec | Minor | | | | | | | | | | | | |
| 4.2.7 | Cross talk | Reference confirmed limit sample | Minor | | | | | | | | | | | | |

12. Handling Precautions

12.1 Mounting method

The LCD panel of AMSON TFT module consists of two thin glass plates with polarizers which easily be damaged. And since the module is so constructed as to be fixed by utilizing fitting holes in the printed circuit board.

Extreme care should be needed when handling the LCD modules.

12.2 Caution of LCD handling and cleaning

When cleaning the display surface, Use soft cloth with solvent [Recommended below] and wipe lightly

- Isopropyl alcohol
- Ethyl alcohol

Do not wipe the display surface with dry or hard materials that will damage the polarizer surface.

Do not use the following solvent:

- Water
- Aromatics

Do not wipe ITO pad area with the dry or hard materials that will damage the ITO patterns

Do not use the following solvent on the pad or prevent it from being contaminated:

- Soldering flux
- Chlorine (Cl) , Sulfur (S)

If goods were sent without being silicon coated on the pad, ITO patterns could be damaged due to the corrosion as time goes on.

If ITO corrosion happens by miss-handling or using some materials such as Chlorine (Cl), Sulfur (S) from customer, Responsibility is on customer.

12.3 Caution against static charge

The LCD module uses C-MOS LSI drivers, so we recommend that you:

Connect any unused input terminal to VDDIO or GND, do not input any signals before power is turned on, and ground your body, work/assembly areas, and assembly equipment to protect against static electricity.

12.4 packing

- Module employs LCD elements and must be treated as such.
- Avoid intense shock and falls from a height.
- To prevent modules from degradation, do not operate or store them exposed direct to sunshine or high temperature/humidity

12.5 Caution for operation

- It is an indispensable condition to drive LCD's within the specified voltage limit since the higher voltage than the limit causes the shorter LCD life.
- An electrochemical reaction due to direct current causes LCD's undesirable deterioration, so that the use of direct current drive should be avoided.
- Response time will be extremely delayed at lower temperature than the operating temperature range and on the other hand at higher temperature LCD's show dark color in them. However those phenomena do not mean malfunction or out of order with LCD's, which will come back in the specified operation temperature.
- If the display area is pushed hard during operation, some font will be abnormally displayed but it resumes normal condition after turning off once.
- Slight dew depositing on terminals is a cause for electro-chemical reaction resulting in terminal open circuit.

Usage under the maximum operating temperature, 50%Rh or less is required.

12.6 storing

In the case of storing for a long period of time for instance, for years for the purpose or replacement use, the following ways are recommended.

- Storage in a polyethylene bag with the opening sealed so as not to enter fresh air outside in it. And with no desiccant.
- Placing in a dark place where neither exposure to direct sunlight nor light's keeping the storage temperature range.
- Storing with no touch on polarizer surface by the anything else.
[It is recommended to store them as they have been contained in the inner container at the time of delivery from us.]

12.7 Safety

- It is recommendable to crash damaged or unnecessary LCD's into pieces and wash off liquid crystal by either of solvents such as acetone and ethanol, which should be burned up later.
- When any liquid leaked out of a damaged glass cell comes in contact with your hands, please wash it off well with soap and water.

13. Precaution for Use

13.1

A limit sample should be provided by the both parties on an occasion when the both parties agreed its necessity. Judgment by a limit sample shall take effect after the limit sample has been established and confirmed by the both parties.

13.2

On the following occasions, the handing of problem should be decided through discussion and agreement between responsible of the both parties.

- When a question is arisen in this specification.
- When a new problem is arisen this is not specified in this specification.
- When an inspection specifications change or operating condition change in customer is reported to AMSON TFT and some problem is arisen in this specification due to the change.
- When a new problem is arisen at the customer's operating set for sample evaluation in the customer site.

14. Packing Method

