

# Specification for Approval

Customer: \_\_\_\_\_

Model Name: \_\_\_\_\_

Supplier Approval			Customer approval
R&D Designed	R&D Approved	QC Approved	
<i>Peter</i>	<i>Peng Jun</i>		



## Table of Contents

List	Description	Page No.
	Cover	1
	Revision Record	2
	Table of Contents	3
1	Scope	4
2	General Information	4
3	External Dimensions	5
4	Interface Description	6
5	Absolute Maximum Ratings	8
6	DC Characteristics	8
7	Timing Characteristics	10
8	Backlight Characteristics	15
9	Optical Characteristics	16
10	Reliability Test Conditions and Methods	18
11	Inspection Standard	19
12	Handling Precautions	23
13	Precaution for Use	24
14	Packing Method	24

## 1. Scope

This specification defines general provisions as well as inspection standards for TFT module supplied by AMSON electronics.

If the event of unforeseen problem or unspecified items may occur, naturally shall negotiate and agree to solution

## 2. General Information

### LCM

ITEM	STANDARD VALUES	UNITS
LCD type	1.54" TFT	--
Dot arrangement	320(RGB) × 320	dots
Color filter array	RGB vertical stripe	--
Display mode	IPS / Transmissive / Normally Black	--
Viewing Direction	80/80/80/80	--
Driver IC	ST7796S	--
Module size	31.52(W) × 33.72(H) × 2.98(T)	mm
Active area	27.744(W) × 27.744(H)	mm
Dot pitch	0.0867(W) × 0.0867(H)	mm
Interface	MIPI-DSI	--
Operating temperature	-20 ~ +70	°C
Storage temperature	-30 ~ +80	°C
Back Light	3 White LED	--
Weight	TBD	g

### CTP

CTP type	1.54"	--
Outline Dimension	40.2(W) × 40.5(H) × 1.35(T)	mm
Touch area	28.12 × 28.12	mm
Max Number of Fingers	1 point and gestures	--
Driver IC	FT6236GMA	--
surface hardness	6H	--
Operating temperature	-20 ~ +70	°C
Storage temperature	-30 ~ +80	°C

## 3. External Dimensions

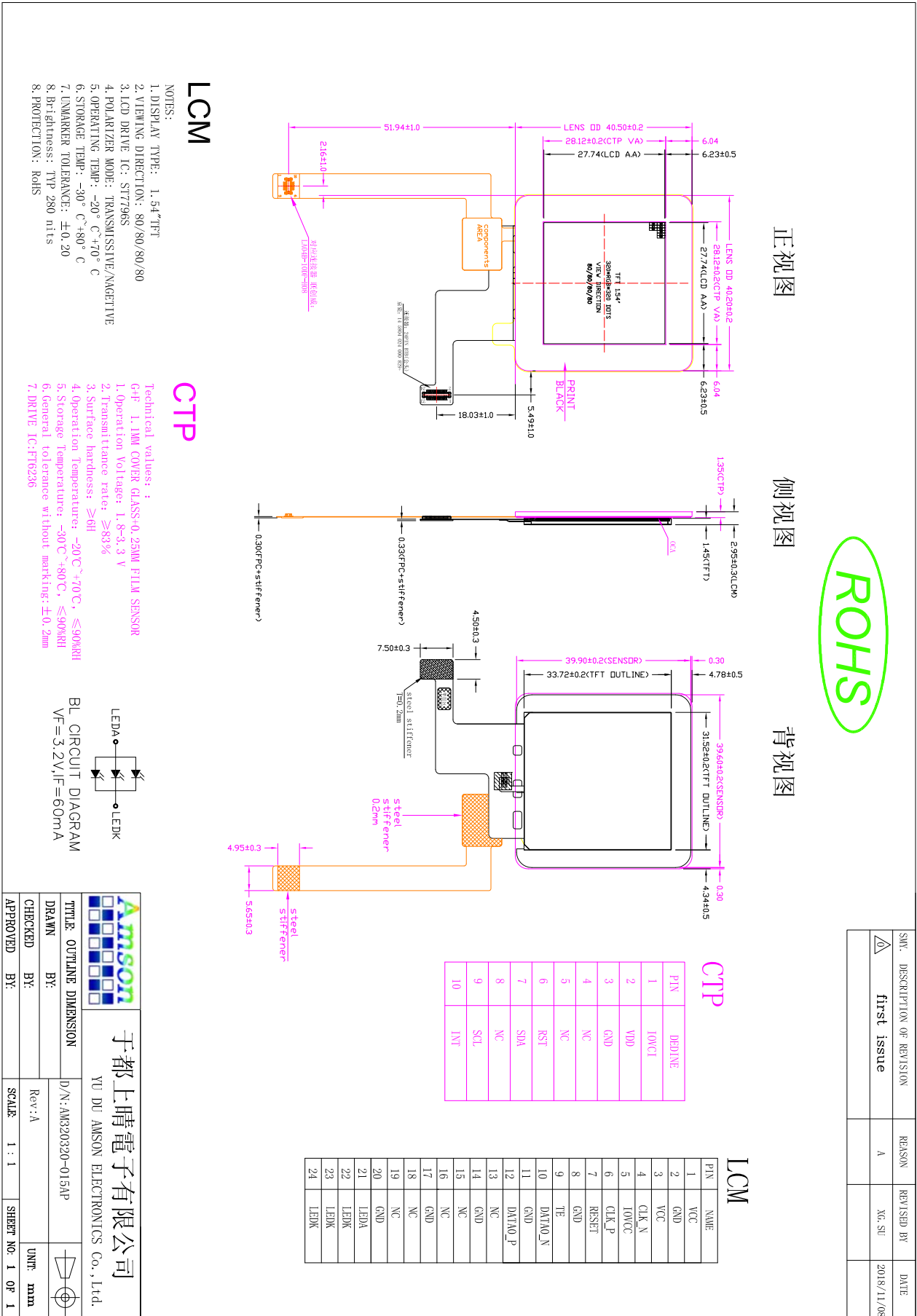

## 4. Interface Description

### 4.1 LCM Interface Description

PIN NO.	PIN NAME	DESCRIPTION
1	VCC	System power supply.
2	GND	System power ground.
3	VCC	System power supply.
4	CLK_N	DSI-CLK- differential clock signals.
5	IOVCC	System power supply.
6	CLK_P	DSI-CLK+ differential clock signals.
7	RESET	Reset signal input terminal, active at 'L'.
8	GND	System power ground.
9	TE	Tearing effect output. If not used, please open this pin.
10	DATA0_N	DSI-DATA- differential data signals.
11	GND	System power ground.
12	DATA0_P	DSI-DATA+ differential data signals.
13	NC	NC.
14	GND	System power ground.
15	NC	NC.
16	NC	NC.
17	GND	System power ground.
18	NC	NC.
19	NC	NC.
20	GND	System power ground.
21	LEDA	Power supply for backlight anode input terminal.
22	LEDK	Power supply for backlight cathode input terminal.
23	LEDK	Power supply for backlight cathode input terminal.
24	LEDK	Power supply for backlight cathode input terminal.

## 4.2 CTP Interface Description

PIN NO.	PIN NAME	DESCRIPTION
1	IOVCI	I/O power supply
2	VDD	power supply voltage
3	GND	System power ground.
4	NC	NC
5	NC	NC
6	RST	External Reset, Low is active
7	SDA	I2C data input and output
8	NC	System power ground.
9	SCL	I2C clock input
10	INT	External interrupt to the host

## 5. Absolute Maximum Ratings

Item	Symbol	Min.	Max.	Unit
Logic Supply Voltage	IOVCC	-0.3	4.6	V
Analog Supply Voltage	VCC	-0.3	4.6	V
CTP Logic Voltage	IOVCI	1.8	3.6	
CTP Analog Voltage	VDD	-0.3	3.6	
Input Voltage	V <sub>in</sub>	-0.3	IOVCC+0.3	V
Operating Temperature	T <sub>OP</sub>	-20	70	°C
Storage Temperature	T <sub>ST</sub>	-30	80	°C
Storage Humidity	HD	20	90	%RH

## 6. DC Characteristics

### 6.1 DC Characteristics for Panel and CTP Driving

Item	Symbol	Min.	Typ.	Max.	Unit	Remark
Logic Supply Voltage	IOVCC	1.65	-	3.3	V	-
Analog Supply Voltage	VCC	2.5	-	3.3	V	-
CTP Logic Voltage	IOVCI	2.8		3.3		
CTP Analog Voltage	VDD	2.8		3.3		
Input High Voltage	V <sub>IH</sub>	0.7IOVCC	-	IOVCC	V	Digital input pins
Input Low Voltage	V <sub>IL</sub>	GND	-	0.3IOVCC	V	Digital input pins
Output High Voltage	V <sub>OH</sub>	0.8IOVCC	-	IOVCC	V	Digital output pins
Output Low Voltage	V <sub>OL</sub>	GND	-	0.2IOVCC	V	Digital output pins
I/O Leak Current	I <sub>LI</sub>	-1.0	-	1.0	uA	-



## 6.2DC characteristics for MIPI DSI

- MIPI Signaling Voltage Levels

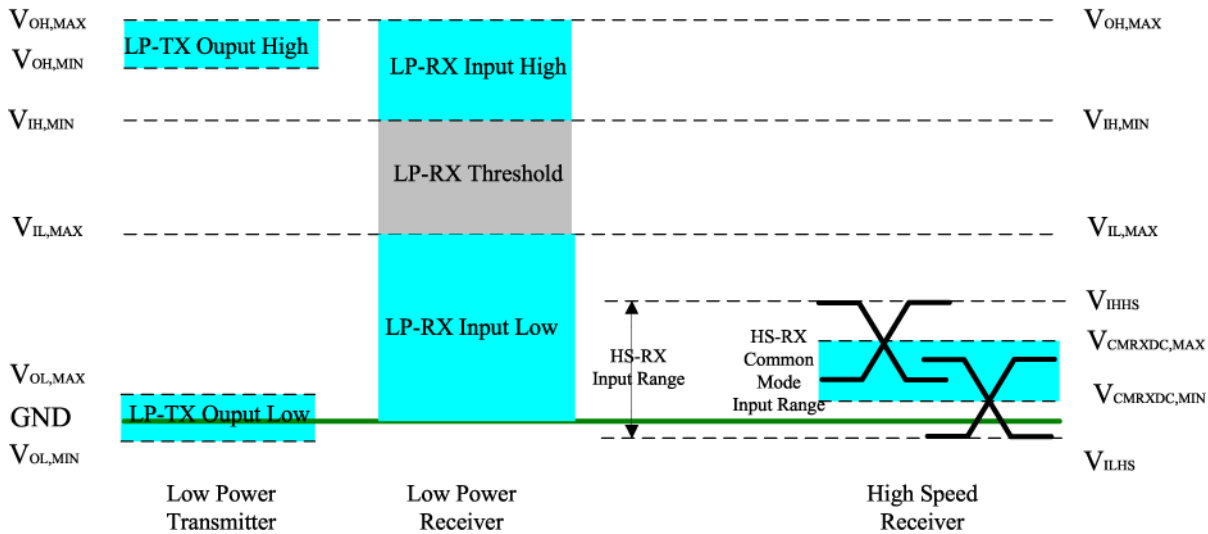

- MIPI DC characteristics

Parameter	Symbol	Specification			Unit
		MIN	TYP	MAX	
Operation Voltage for MIPI Receiver					
Low power mode operating voltage	$V_{LPH}$	1.1	1.2	1.3	V
MIPI Characteristics for High Speed Receiver					
Single-ended input low voltage	$V_{ILHS}$	-40	-	-	mV
Single-ended input high voltage	$V_{IHHS}$	-	-	460	mV
Common-mode voltage	$V_{CMRXDC}$	70	-	330	mV
Differential input impedance	$Z_{ID}$	80	100	125	ohm
MIPI Characteristics for Low Power Mode					
Pad signal voltage range	$V_i$	-50	-	1350	mV
Logic 0 input threshold	$V_{IL}$	0	-	550	mV
Logic 1 input threshold	$V_{IH}$	880	-	1350	mV
Output low level	$V_{OL}$	-50	-	50	mV
Output high level	$V_{OH}$	1.1	1.2	1.3	V

## 7. Timing Characteristics

### 7.1 MIPI Timing Characteristics

#### High Speed Mode – Clock Channel Timing

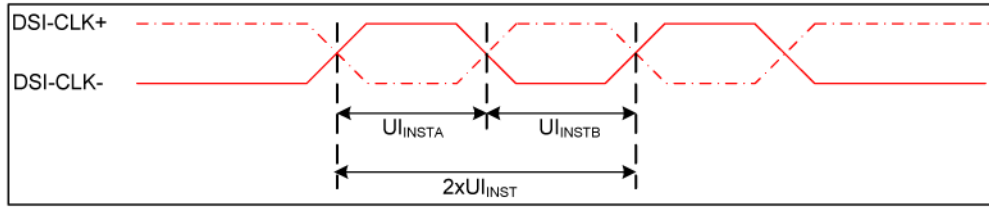

Signal	Symbol	Parameter	MIN	MAX	Unit	Description
DSI-DATA_P/N	2xUI INST	Double UI instantaneous	4	25	ns	
DSI-DATA_P/N	UI INSTA ,UI INSTB	UI instantaneous Half	2	12.5	ns	

#### High-Speed Data Transmission

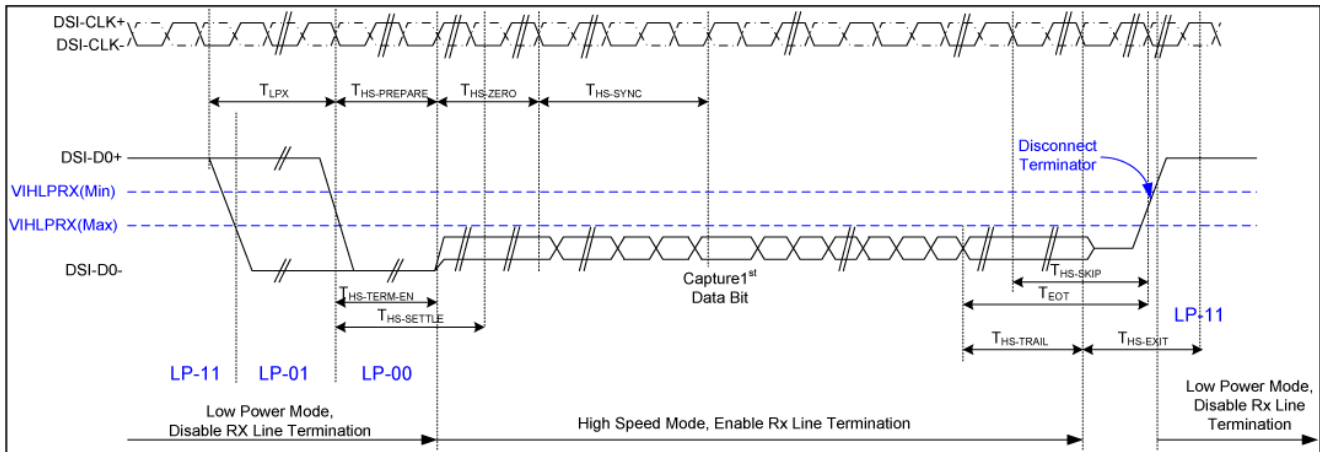

Parameter	Symbol	MIN	TYP	MAX	Unit
Time to drive LP-00 to prepare for HS transmission	$T_{HS-PREPARE}$	40+4UI		85+6UI	ns
Time from start of $t_{HS-TRAIL}$ or $t_{CLK-TRAIL}$ period to start of LP-11 state	$T_{EOT}$			105+12UI	ns
Time to enable data receiver line termination measured from when $D_n$ crosses $V_{ILMAX}$	$T_{HS-TERM-EN}$			35+4UI	ns
Time to drive flipped differential state after last payload data bit of a HS transmission	$T_{HS-TRAIL}$	60+4UI			ns
Time-out at RX to ignore transition period of EoT	$T_{HS-SKIP}$	40		55+4UI	ns
Time to drive LP-11 after HS burst	$T_{HS-EXIT}$	100			ns
Length of any Low-Power state period	$T_{LPX}$	50			ns
Sync sequence period	$T_{HS-SYNC}$		8UI		ns
Minimum lead HS-0 drive period before the Sync sequence	$T_{HS-ZERO}$	105+6UI			ns

## Switching the Clock Lane between Clock Transmission and Low-Power Mode

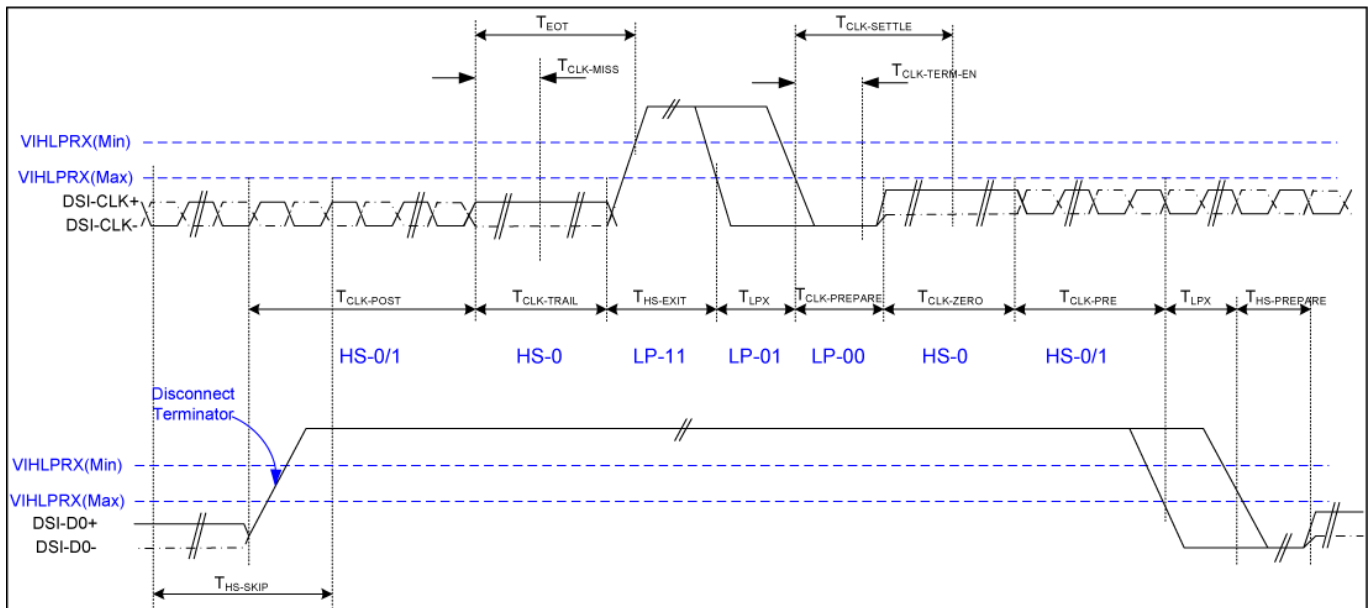

Parameter	Symbol	MIN	TYP	MAX	Unit
Time that the transmitter shall continue sending HS clock after the last associated Data Lane has transitioned to LP mode	$T_{CLK-POST}$	60+52UI			ns
Detection time that the clock has stopped toggling	$T_{CLK-MISS}$			60	ns
Time to drive LP-00 to prepare for HS clock transmission	$T_{CLK-PREPARE}$	38		95	ns
Minimum lead HS-0 drive period before starting Clock	$T_{CLK-PREPARE} + T_{CLK-ZERO}$	300			ns
Time to enable Clock Lane receiver line termination measured from when Dn cross VIL,MAX	$T_{HS-TERM-EN}$			38	ns
Minimum time that the HS clock must be set prior to any associated data lane beginning the transmission from LP to HS mode	$T_{CLK-PRE}$	8			UI
Time to drive HS differential state after last payload clock bit of a HS transmission burst	$T_{CLK-TRAIL}$	60			ns

## Bus Turnaround Procedure

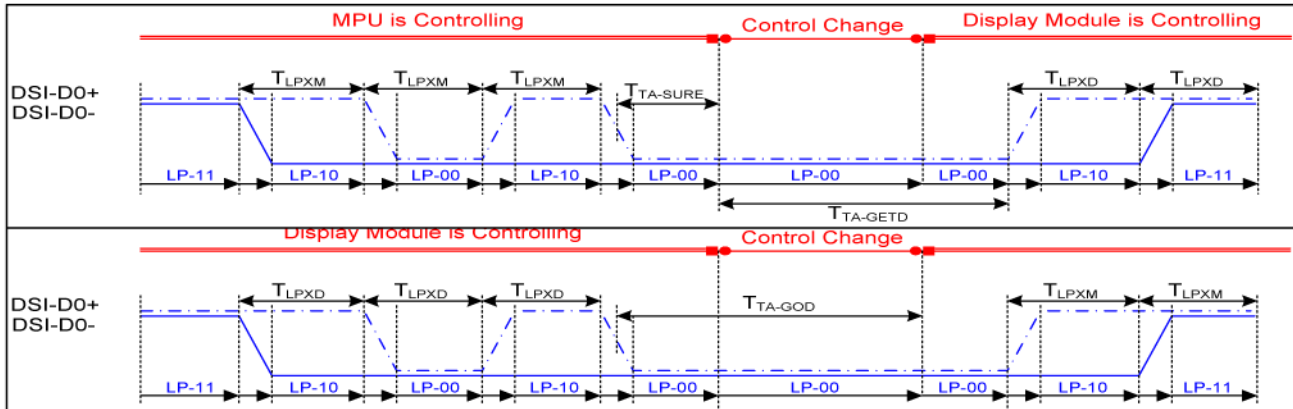

Parameter	Symbol	MIN	TYP	MAX	Unit
Length of any Low-Power state period : Master side	T <sub>LPX</sub>	50		75	ns
Length of any Low-Power state period : Slave side	T <sub>LPX</sub>	47.5	50	52.5	ns
Ratio of T <sub>LPX</sub> (MASTER)/ T <sub>LPX</sub> (SLAVE) between Master and Slave side	Ratio T <sub>LPX</sub>	2/3		3/2	
Time-out before new TX side start driving	T <sub>TA-SURE</sub>	T <sub>LPX</sub>		2 T <sub>LPX</sub>	ns
Time to drive LP-00 by new TX	T <sub>TA-GET</sub>		5 T <sub>LPX</sub>		ns
Time to drive LP-00 after Turnaround Request	T <sub>TA-GO</sub>		4 T <sub>LPX</sub>		ns

## 7.2 CTP Timing Characteristics

### 7.2.1 I2C Timing Characteristics

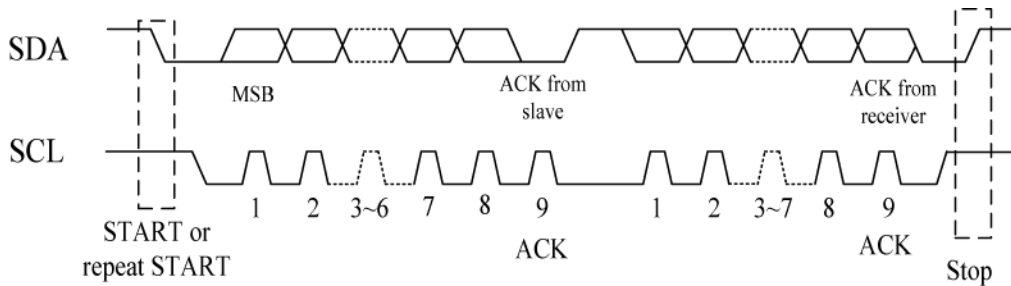

I2C Serial Data Transfer Format

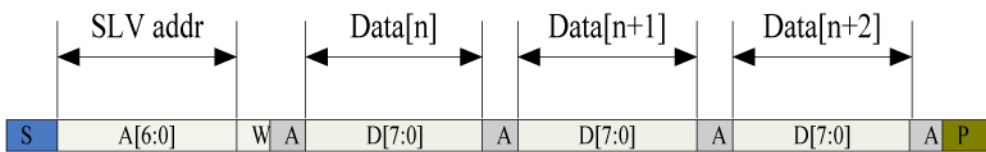

I2C master write, slave read

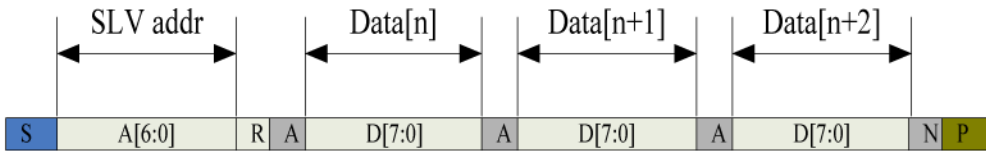

I2C master read, slave write

Parameter	Min	Max	Unit
SCL frequency	10	400	KHz
Bus free time between a STOP and START condition	4.7	\	us
Hold time (repeated) START condition	4.0	\	us
Data setup time	250	\	ns
Setup time for a repeated START condition	4.7	\	us
Setup Time for STOP condition	4.0	\	us

I2C Timing Characteristics

## 7.2.2 Power ON/Reset/Wake Sequence

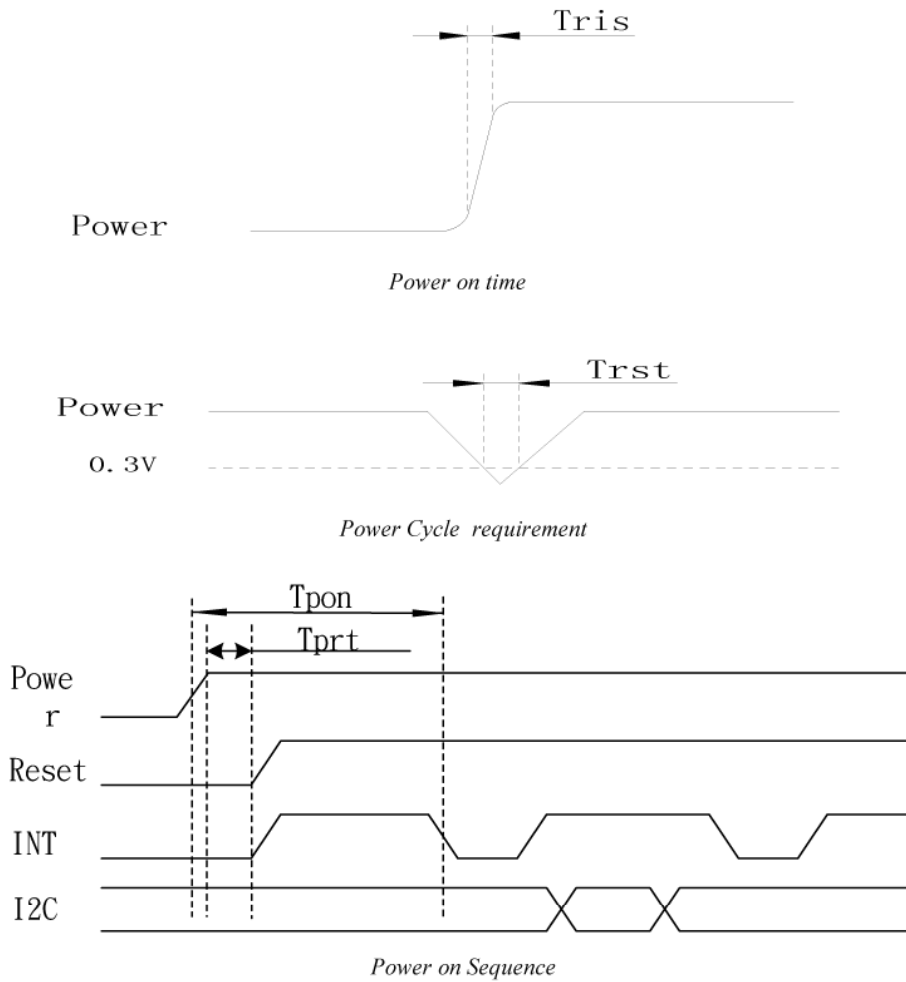

Reset time must be enough to guarantee reliable reset, the time of starting to report point after resetting approach to the time of starting to report point after powering on.

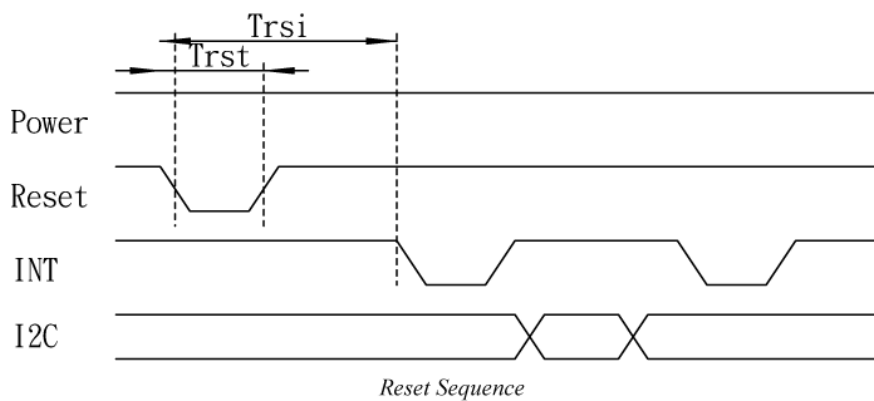

Parameter	Description	Min	Max	Units
$T_{ris}$	Rise time from 0.1VDD to 0.9VDD	-	3	ms
$T_{pon}$	Time of starting to report point after powering on	300	-	ms
$T_{prt}$	Time of being low after powering on	1	-	ms
$T_{rsi}$	Time of starting to report point after resetting	300	-	ms
$T_{rst}$	Reset time	5	-	ms

Power on/Reset/Wake Sequence Parameters

## 8. Backlight Characteristic

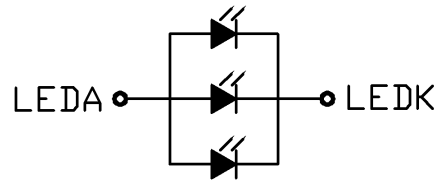

BL CIRCUIT DIAGRAM  
 $V_F = 3.2V, I_F = 60mA$

Item	Symbol	MIN	TYP	MAX	UNIT	Test Condition
Supply Voltage	Vf	2.9	3.2	3.5	V	If=60mA
Supply Current	If	-	60	75	mA	-
Luminous Intensity for LCM	-	230	280	-	Cd/m <sup>2</sup>	If=60mA
Life Time	-	20000	-	-	Hr	If=60mA
Backlight Color	White					

## 9. Optical Characteristics

Item	Conditions		Min.	Typ.	Max.	Unit	Note
Viewing Angle (CR>10)	Horizontal	$\theta_L$		80	-	degree	(1),(2),(6)
		$\theta_R$		80	-		
	Vertical	$\theta_T$		80	-		
		$\theta_B$		80	-		
Contrast Ratio	Center		-	900	-	-	(1),(3),(6)
Response Time	Rising		-	5	-	ms	(1),(4),(6)
	Falling		-	15	-	ms	
CF Color Chromaticity (CIE1931)	Red x		Typ. -0.05	TBD	Typ. +0.05	-	(1), (6)
	Red y			TBD		-	
	Green x			TBD		-	
	Green y			TBD		-	
	Blue x			TBD		-	
	Blue y			TBD		-	
	White x			TBD		-	
	White y			TBD		-	
NTSC	CIE1931		-	55.3	-	%	(1),(6)

Note (1) Measurement Setup: The LCD module should be stabilized at given temp. 25°C for 15 minutes to avoid abrupt temperature change during measuring. In order to stabilize the luminance, the measurement should be executed after lighting backlight for 15 minutes in a windless room.

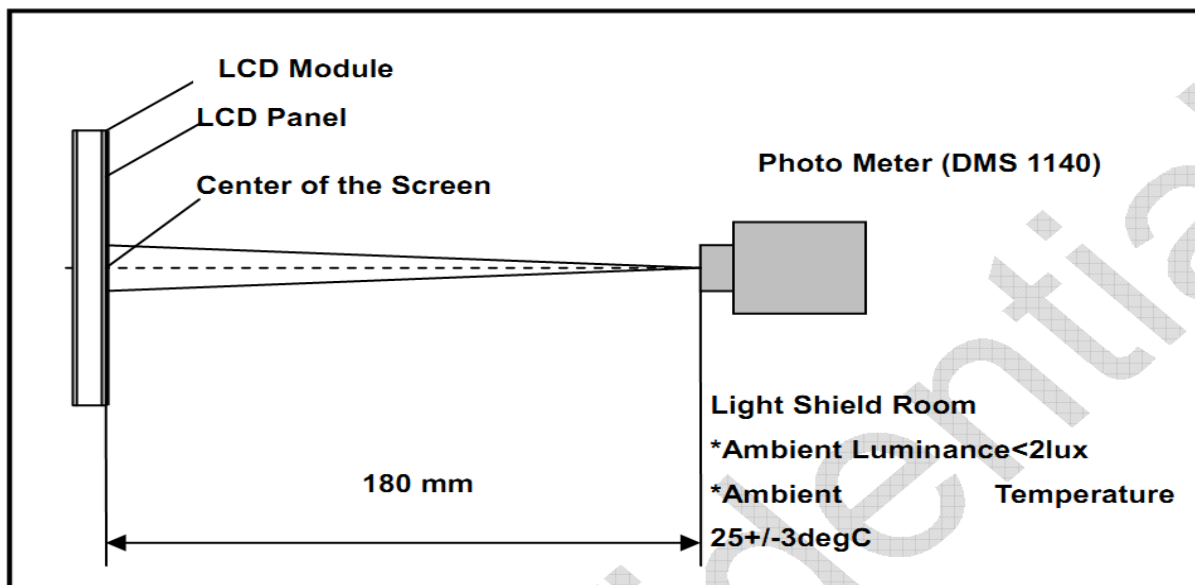



Note (2) Definition of Viewing Angle

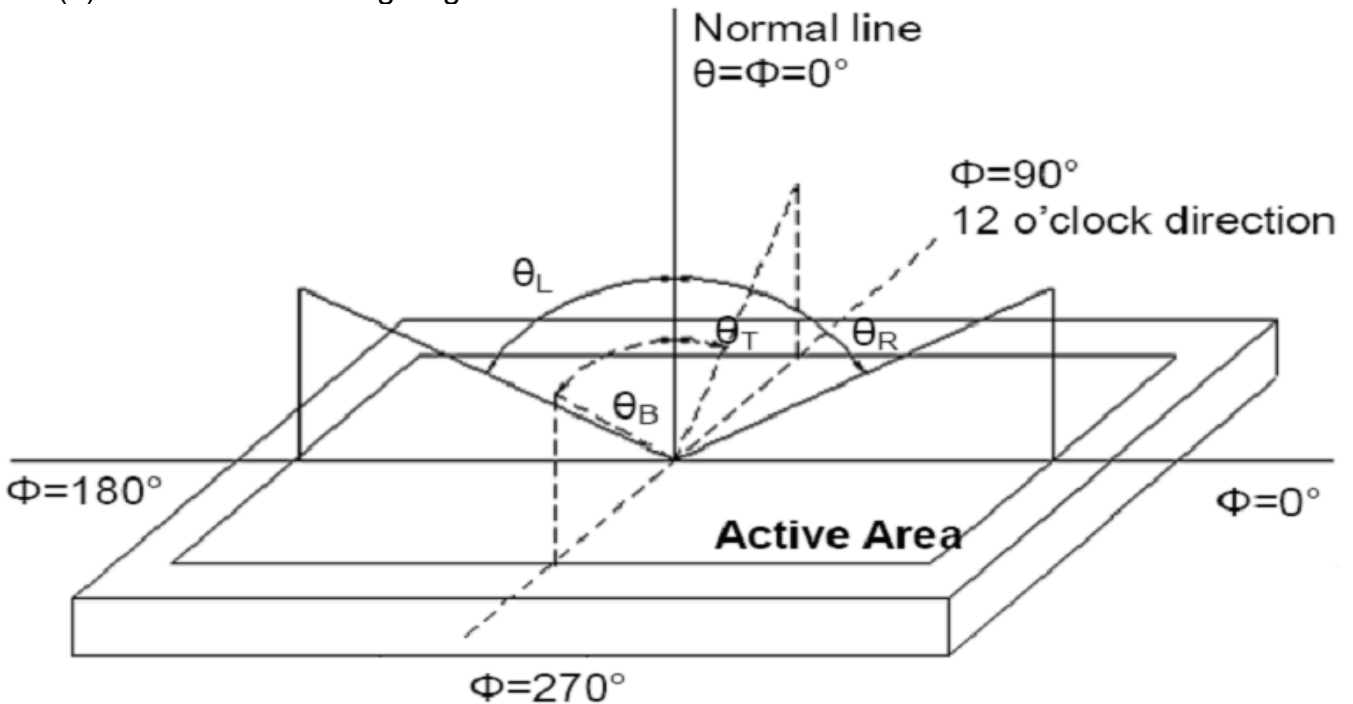

Note (3) Definition of Contrast Ratio (CR)

The contrast ratio can be calculated by the following expression

$$\text{Contrast Ratio (CR)} = L_{63} / L_0$$

L63: Luminance of gray level 63, L0: Luminance of gray level 0

Note (4) Definition of response time

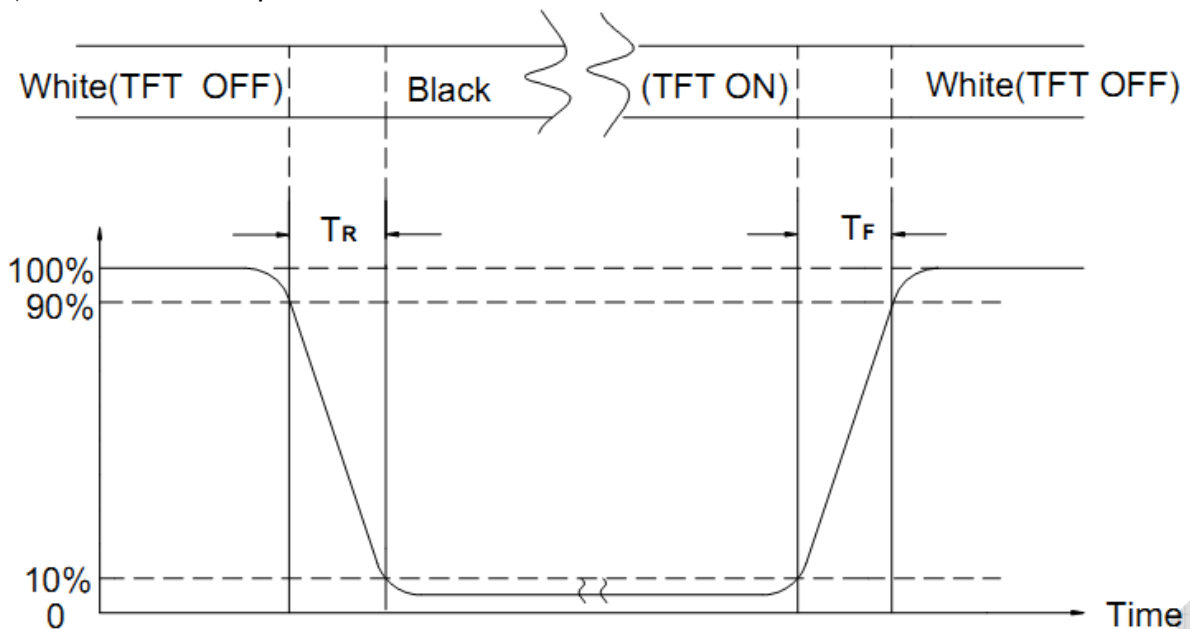

Note (5) Definition of Transmittance (Module is without signal input)

$$\text{Transmittance} = \text{Center Luminance of LCD} / \text{Center Luminance of Back Light} \times 100\%$$

Note (6) Definition of color chromaticity (CIE1931)

Color coordinates measured at the center point of LCD

## 10. Reliability Test Conditions And Methods

NO.	TEST ITEMS	TEST CONDITION	INSPECTION AFTER TEST
①	High Temperature Storage	80°C±2°C×96Hours	Inspection after 2~4hours storage at room temperature, the samples should be free from defects: 1, Air bubble in the LCD. 2, Seal leak. 3, Non-display. 4, Missing segments. 5, Glass crack. 6, Current IDD is twice higher than initial value. 7, The surface shall be free from damage. 8, The electric characteristic requirements shall be satisfied.
②	Low Temperature Storage	-30°C±2°C×96Hours	
③	High Temperature Operating	70°C±2°C×96Hours	
④	Low Temperature Operating	-20°C±2°C×96Hours	
⑤	Temperature Cycle(Storage)	-20°C ↔ 25°C ↔ 70°C (30min) ↔ (5min) ↔ (30min) 1cycle Total 10cycle	
⑥	Damp Proof Test (Storage)	50°C±5°C×90%RH×120Hours	
⑦	Vibration Test	Frequency:10Hz~55Hz~10Hz Amplitude:1.5MM X,Y,Z direction for total 3hours (packing condition test will be tested by a carton)	
⑧	Drooping Test	Drop to the ground from 1M height one time every side of carton. (packing condition test will be tested by a carton)	
⑨	ESD Test	Voltage:±8KV,R:330Ω,C:150PF,Air Mode,10times	

### REMARK:

- 1, The Test samples should be applied to only one test item.
- 2, Sample side for each test item is 5~10pcs.
- 3, For Damp Proof Test, Pure water(Resistance > 10MΩ) should be used.
- 4, In case of malfunction defect caused by ESD damage, if it would be recovered to normal state after resetting, it would be judge as a good part.
- 5, EL evaluation should be accepted from reliability test with humidity and temperature: Some defects such as black spot/blemish can happen by natural chemical reaction with humidity and Fluorescence EL has.
- 6, Failure Judgment Criterion: Basic Specification Electrical Characteristic, Mechanical Characteristic, Optical Characteristic.

## 11. Inspection Standard

### 11.1 Incoming Inspection and Standard:

The below incoming inspection are applied to the TFT LCM Modules supplied by AMSON Optoelectronic Industry CO.,LTD. The customers should inspect the LCM within 14 days after receiving the goods. The result of inspection should be notified to the Seller in the writing copy promptly, if the customer do not send them within 14 days, the seller has the right to judge as acceptance of goods. The inspection lot size is treated as the quantity per shipment and per model. The sampling plan shall be inspected under MIL-STD015E in Level II by single sampling. The acceptable quality level (AQL) are categorized as below grades:

CRITICAL= 0.65%, MAJOR= 0.65%, MINOR= 1.5%

### 11.2 Inspection condition and Warranty policy:

The delivered LCM should be stored properly, ideally under climate-controlled environment at 25 (±5) degree Celsius as well as 60% (±10) Relative Humidity. The LCM shall be inspected in the viewing angle of 45 degree from the four major angles (U/D/L/R) under the single fluorescent lamp of 20W (equal to 300 to 500 lux). For warranty, AMSON Optoelectronic Industry CO.,LTD. will provide 12 months of warranty period as standard, and provide the new replacement for the defective products which belong to the Seller's responsibility verified by the quality department.

### 11.3 Inspection Criteria:

#### 11.3.1 Critical defect (重度缺失)

Item No.	Inspection content	Judgement
11.3.1.1	Functional defects	No display, abnormal display, short circuit, missing line, off-contrast and chromaticity, Touch Panel non-function
11.3.1.2	Model mixed	Other model mixed

#### 11.3.2 Major defect: (主要缺失)

Item No.	Inspection content	Judgement
11.3.2.1	Product indication	Missing model no. and wrong model no. is indicated on the LCM.
11.3.2.2	Glass cracking	The LCD and touch panel glass crack or breakage
11.3.2.3	Missing component	The function component missing such as connector, cable, etc.

### 11.3.3 Minor defect (LCD) : (次要缺失)

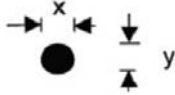
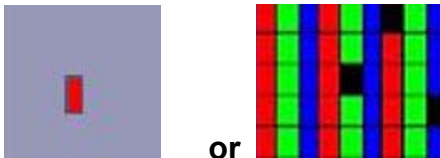
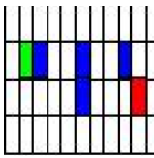
Item No.	Inspection content	Judgement												
11.3.3.1	Black/White spot Foreign particles Dust in the cell	$\phi = (x+y) / 2$  <table border="1"> <thead> <tr> <th>Diameter (mm)</th> <th>Acceptable Q'ty</th> </tr> </thead> <tbody> <tr> <td><math>\Phi \leq 0.1</math></td> <td>Ignore</td> </tr> <tr> <td><math>0.1 &lt; \Phi \leq 0.25</math></td> <td>3 (Distance&gt;5mm)</td> </tr> <tr> <td><math>0.25 &lt; \Phi</math></td> <td>Not allowed</td> </tr> </tbody> </table>	Diameter (mm)	Acceptable Q'ty	$\Phi \leq 0.1$	Ignore	$0.1 < \Phi \leq 0.25$	3 (Distance>5mm)	$0.25 < \Phi$	Not allowed				
Diameter (mm)	Acceptable Q'ty													
$\Phi \leq 0.1$	Ignore													
$0.1 < \Phi \leq 0.25$	3 (Distance>5mm)													
$0.25 < \Phi$	Not allowed													
11.3.3.2	Linear defect Black/white line Black/white scratch	<table border="1"> <thead> <tr> <th>Length(mm)</th> <th>Width (mm)</th> <th>Acceptable Q'ty</th> </tr> </thead> <tbody> <tr> <td></td> <td><math>W \leq 0.03</math></td> <td>Ignore</td> </tr> <tr> <td><math>L \leq 5.0</math></td> <td><math>0.03 &lt; W \leq 0.07</math></td> <td>3</td> </tr> <tr> <td></td> <td><math>0.07 &lt; W</math></td> <td>Follow 11.3.3.1</td> </tr> </tbody> </table>	Length(mm)	Width (mm)	Acceptable Q'ty		$W \leq 0.03$	Ignore	$L \leq 5.0$	$0.03 < W \leq 0.07$	3		$0.07 < W$	Follow 11.3.3.1
Length(mm)	Width (mm)	Acceptable Q'ty												
	$W \leq 0.03$	Ignore												
$L \leq 5.0$	$0.03 < W \leq 0.07$	3												
	$0.07 < W$	Follow 11.3.3.1												
11.3.3.3	Polarizer Bubbles Dent on polarizer	<table border="1"> <thead> <tr> <th>Diameter (mm)</th> <th>Acceptable Q'ty</th> </tr> </thead> <tbody> <tr> <td><math>\Phi \leq 0.2</math></td> <td>Ignore</td> </tr> <tr> <td><math>0.2 &lt; \Phi \leq 0.5</math></td> <td>2 (Distance&gt;5mm)</td> </tr> <tr> <td><math>0.5 &lt; \Phi</math></td> <td>Not allowed</td> </tr> </tbody> </table>	Diameter (mm)	Acceptable Q'ty	$\Phi \leq 0.2$	Ignore	$0.2 < \Phi \leq 0.5$	2 (Distance>5mm)	$0.5 < \Phi$	Not allowed				
Diameter (mm)	Acceptable Q'ty													
$\Phi \leq 0.2$	Ignore													
$0.2 < \Phi \leq 0.5$	2 (Distance>5mm)													
$0.5 < \Phi$	Not allowed													
11.3.3.4	Electrical defect Dot	<p><b>Bright dot and Dark dot definition:</b></p>  <p>or</p>  <p>(Two adjacent dot)</p> <p><b>Inspection pattern: black, white, red, green, and blue screen.</b></p> <table border="1"> <thead> <tr> <th>Items</th> <th>Acceptable Q'ty</th> </tr> </thead> <tbody> <tr> <td>Bright dot</td> <td><math>N \leq 4</math> (Distance &gt;5mm)</td> </tr> <tr> <td>Dark dot</td> <td><math>N \leq 4</math> (Distance &gt;5mm)</td> </tr> </tbody> </table>	Items	Acceptable Q'ty	Bright dot	$N \leq 4$ (Distance >5mm)	Dark dot	$N \leq 4$ (Distance >5mm)						
Items	Acceptable Q'ty													
Bright dot	$N \leq 4$ (Distance >5mm)													
Dark dot	$N \leq 4$ (Distance >5mm)													

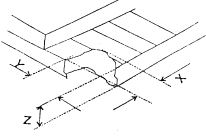
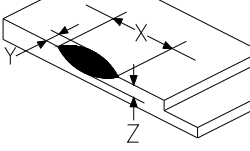
<b>11.3.3.5</b>	<b>Glass Defect- Corner chipping</b>	 <table border="1" data-bbox="703 389 1410 665"> <thead> <tr> <th>Size(mm)</th> <th>Judgement</th> </tr> </thead> <tbody> <tr> <td> <math>X \leq 3\text{mm}, Y \leq S,</math>  <math>Z \leq T</math>            (S= ITO length,            T=Single glass            thickness)         </td> <td>Accept</td> </tr> </tbody> </table>	Size(mm)	Judgement	$X \leq 3\text{mm}, Y \leq S,$ $Z \leq T$ (S= ITO length, T=Single glass thickness)	Accept
Size(mm)	Judgement					
$X \leq 3\text{mm}, Y \leq S,$ $Z \leq T$ (S= ITO length, T=Single glass thickness)	Accept					
<b>11.3.3.6</b>	<b>Glass Defect- Side fragment</b>	 <table border="1" data-bbox="703 864 1410 1072"> <thead> <tr> <th>Size(mm)</th> <th>Judgement</th> </tr> </thead> <tbody> <tr> <td> <math>X \leq 2 \text{ mm}, Y \leq \text{border edge}</math>  <math>Z \leq T</math>            (T= single glass thickness)         </td> <td>Accept</td> </tr> </tbody> </table>	Size(mm)	Judgement	$X \leq 2 \text{ mm}, Y \leq \text{border edge}$ $Z \leq T$ (T= single glass thickness)	Accept
Size(mm)	Judgement					
$X \leq 2 \text{ mm}, Y \leq \text{border edge}$ $Z \leq T$ (T= single glass thickness)	Accept					

### 11.3.4 Minor defect (Touch Panel)

Item No.	Inspection content	Judgement								
<b>11.3.4.1</b>	<b>Scratch, dust, particles, foreign materials in "linear type"</b>	<table border="1" data-bbox="703 1397 1410 1659"> <thead> <tr> <th>Size (mm)</th> <th>Acceptable Q'ty</th> </tr> </thead> <tbody> <tr> <td><math>W \leq 0.05\text{mm}, L \leq 10\text{mm}</math></td> <td>Ignore</td> </tr> <tr> <td><math>0.05\text{mm} &lt; W \leq 0.07\text{mm}, L \leq 10\text{mm}</math></td> <td>3</td> </tr> <tr> <td><math>W &gt; 0.07\text{mm}</math></td> <td>Reject</td> </tr> </tbody> </table>	Size (mm)	Acceptable Q'ty	$W \leq 0.05\text{mm}, L \leq 10\text{mm}$	Ignore	$0.05\text{mm} < W \leq 0.07\text{mm}, L \leq 10\text{mm}$	3	$W > 0.07\text{mm}$	Reject
Size (mm)	Acceptable Q'ty									
$W \leq 0.05\text{mm}, L \leq 10\text{mm}$	Ignore									
$0.05\text{mm} < W \leq 0.07\text{mm}, L \leq 10\text{mm}$	3									
$W > 0.07\text{mm}$	Reject									
<b>11.3.4.2</b>	<b>Scratch, dust, particles, foreign materials in "round type"</b>	<table border="1" data-bbox="703 1738 1410 1973"> <thead> <tr> <th>Diameter (mm)</th> <th>Acceptable Q'ty</th> </tr> </thead> <tbody> <tr> <td><math>\Phi \leq 0.25\text{mm}</math></td> <td>Ignore</td> </tr> <tr> <td><math>0.25\text{mm} &lt; \Phi \leq 0.35\text{mm}</math></td> <td>5</td> </tr> <tr> <td><math>\Phi &gt; 0.35\text{mm}</math></td> <td>Reject</td> </tr> </tbody> </table>	Diameter (mm)	Acceptable Q'ty	$\Phi \leq 0.25\text{mm}$	Ignore	$0.25\text{mm} < \Phi \leq 0.35\text{mm}$	5	$\Phi > 0.35\text{mm}$	Reject
Diameter (mm)	Acceptable Q'ty									
$\Phi \leq 0.25\text{mm}$	Ignore									
$0.25\text{mm} < \Phi \leq 0.35\text{mm}$	5									
$\Phi > 0.35\text{mm}$	Reject									

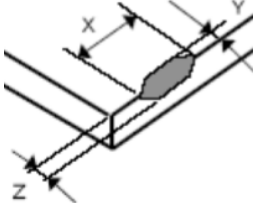
<b>11.3.4.3</b>	<b>Air bubbles</b>	<table border="1"> <thead> <tr> <th>Diameter (mm)</th> <th>Acceptable Q'ty</th> </tr> </thead> <tbody> <tr> <td><math>\Phi \leq 0.2\text{mm}</math></td> <td>Ignore</td> </tr> <tr> <td><math>0.2\text{mm} &lt; \Phi \leq 0.5\text{mm}</math></td> <td>3</td> </tr> <tr> <td><math>\Phi &gt; 0.5\text{mm}</math></td> <td>Reject</td> </tr> </tbody> </table>	Diameter (mm)	Acceptable Q'ty	$\Phi \leq 0.2\text{mm}$	Ignore	$0.2\text{mm} < \Phi \leq 0.5\text{mm}$	3	$\Phi > 0.5\text{mm}$	Reject
Diameter (mm)	Acceptable Q'ty									
$\Phi \leq 0.2\text{mm}$	Ignore									
$0.2\text{mm} < \Phi \leq 0.5\text{mm}$	3									
$\Phi > 0.5\text{mm}$	Reject									
<b>11.3.4.5</b>	<b>Scratch on printing area</b>	<table border="1"> <thead> <tr> <th>Size (mm)</th> <th>Acceptable Q'ty</th> </tr> </thead> <tbody> <tr> <td><math>W \leq 0.03\text{mm}, L \leq 5\text{ mm}</math></td> <td>Ignore</td> </tr> <tr> <td><math>0.03\text{mm} &lt; W \leq 0.05\text{mm}, L \leq 5\text{mm}</math></td> <td>3</td> </tr> <tr> <td><math>W &gt; 0.05\text{mm}</math> or <math>L &gt; 5\text{mm}</math></td> <td>Reject</td> </tr> </tbody> </table>	Size (mm)	Acceptable Q'ty	$W \leq 0.03\text{mm}, L \leq 5\text{ mm}$	Ignore	$0.03\text{mm} < W \leq 0.05\text{mm}, L \leq 5\text{mm}$	3	$W > 0.05\text{mm}$ or $L > 5\text{mm}$	Reject
Size (mm)	Acceptable Q'ty									
$W \leq 0.03\text{mm}, L \leq 5\text{ mm}$	Ignore									
$0.03\text{mm} < W \leq 0.05\text{mm}, L \leq 5\text{mm}$	3									
$W > 0.05\text{mm}$ or $L > 5\text{mm}$	Reject									
<b>11.3.4.6</b>	<b>Corner chipping</b>	 <table border="1"> <thead> <tr> <th>Size(mm)</th> <th>Judgement</th> </tr> </thead> <tbody> <tr> <td> <math>X \leq 2\text{mm}, Y \leq 2\text{mm}</math>  <math>Z &lt; 1/2T</math>            (T= single glass thickness)         </td> <td>Accept</td> </tr> </tbody> </table>	Size(mm)	Judgement	$X \leq 2\text{mm}, Y \leq 2\text{mm}$ $Z < 1/2T$ (T= single glass thickness)	Accept				
Size(mm)	Judgement									
$X \leq 2\text{mm}, Y \leq 2\text{mm}$ $Z < 1/2T$ (T= single glass thickness)	Accept									
<b>11.3.4.7</b>	<b>Edge chipping</b>	 <table border="1"> <thead> <tr> <th>Size(mm)</th> <th>Judgement</th> </tr> </thead> <tbody> <tr> <td> <math>X \leq 3\text{ mm}, Y \leq 3\text{ mm}</math>  <math>Z \leq 1/2 T</math>            (T= single glass thickness)         </td> <td>Accept</td> </tr> </tbody> </table>	Size(mm)	Judgement	$X \leq 3\text{ mm}, Y \leq 3\text{ mm}$ $Z \leq 1/2 T$ (T= single glass thickness)	Accept				
Size(mm)	Judgement									
$X \leq 3\text{ mm}, Y \leq 3\text{ mm}$ $Z \leq 1/2 T$ (T= single glass thickness)	Accept									

## 12. Handling Precautions

### 12.1 Mounting method

The LCD panel of AMSON TFT module consists of two thin glass plates with polarizers which easily be damaged. And since the module is so constructed as to be fixed by utilizing fitting holes in the printed circuit board.

Extreme care should be needed when handling the LCD modules.

### 12.2 Caution of LCD handling and cleaning

When cleaning the display surface, Use soft cloth with solvent

[Recommended below] and wipe lightly

- Isopropyl alcohol
- Ethyl alcohol

Do not wipe the display surface with dry or hard materials that will damage the polarizer surface.

Do not use the following solvent:

- Water
- Aromatics

Do not wipe ITO pad area with the dry or hard materials that will damage the ITO patterns

Do not use the following solvent on the pad or prevent it from being contaminated:

- Soldering flux
- Chlorine (Cl) , Sulfur (S)

If goods were sent without being silicon coated on the pad, ITO patterns could be damaged due to the corrosion as time goes on.

If ITO corrosion happens by miss-handling or using some materials such as Chlorine (Cl), Sulfur (S) from customer, Responsibility is on customer.

### 12.3 Caution against static charge

The LCD module uses C-MOS LSI drivers, so we recommend that you:

Connect any unused input terminal to POWER or GROUND, do not input any signals before power is turned on, and ground your body, work/assembly areas, and assembly equipment to protect against static electricity.

### 12.4 packing

- Module employs LCD elements and must be treated as such.
- Avoid intense shock and falls from a height.
- To prevent modules from degradation, do not operate or store them exposed direct to sunshine or high temperature/humidity

### 12.5 Caution for operation

- It is an indispensable condition to drive LCD's within the specified voltage limit since the higher voltage than the limit causes the shorter LCD life.
- An electrochemical reaction due to direct current causes LCD's undesirable deterioration, so that the use of direct current drive should be avoided.
- Response time will be extremely delayed at lower temperature than the operating temperature range and on the other hand at higher temperature LCD's show dark color in them. However those phenomena do not mean malfunction or out of order with LCD's, which will come back in the specified operation temperature.
- If the display area is pushed hard during operation, some font will be abnormally displayed but it resumes normal condition after turning off once.
- Slight dew depositing on terminals is a cause for electro-chemical reaction resulting in terminal open circuit.

Usage under the maximum operating temperature, 50%Rh or less is required.

## 12.6 storing

In the case of storing for a long period of time for instance, for years for the purpose or replacement use, the following ways are recommended.

- Storage in a polyethylene bag with the opening sealed so as not to enter fresh air outside in it . And with no desiccant.
- Placing in a dark place where neither exposure to direct sunlight nor light's keeping the storage temperature range.
- Storing with no touch on polarizer surface by the anything else.  
[It is recommended to store them as they have been contained in the inner container at the time of delivery from us

## 12.7 Safety

- It is recommendable to crash damaged or unnecessary LCD's into pieces and wash off liquid crystal by either of solvents such as acetone and ethanol, which should be burned up later.
- When any liquid leaked out of a damaged glass cell comes in contact with your hands, please wash it off well with soap and water

## 13. Precaution for Use

### 13.1

A limit sample should be provided by the both parties on an occasion when the both parties agreed its necessity. Judgment by a limit sample shall take effect after the limit sample has been established and confirmed by the both parties.

### 13.2

On the following occasions, the handing of problem should be decided through discussion and agreement between responsible of the both parties.

- When a question is arisen in this specification.
- When a new problem is arisen which is not specified in this specifications?
- When an inspection specifications change or operating condition change in customer is reported to AMSON TFT and some problem is arisen in this specification due to the change.
- When a new problem is arisen at the customer's operating set for sample evaluation in the customer site.

## 14. Packing Method

TBD