

Specification for Approval

Customer: _____

Model Name: _____

Supplier Approval			Customer approval
R&D Designed	R&D Approved	QC Approved	
<i>Peter</i>	<i>Peng Jun</i>		

Table of Contents

List	Description	Page No.
	Cover	1
	Revision Record	2
	Table of Contents	3
1	Scope	4
2	General Information	4
3	External Dimensions	5
4	Interface Description	6
5	Absolute Maximum Ratings	7
6	DC Characteristics	7
7	Timing Characteristics	8
8	Backlight Characteristics	12
9	Optical Characteristics	13
10	Reliability Test Conditions and Methods	15
11	Inspection Standard	16
12	Handling Precautions	20
13	Precaution for Use	21
14	Packing Method	21

1. Scope

This specification defines general provisions as well as inspection standards for TFT module supplied by AMSON electronics.

If the event of unforeseen problem or unspecified items may occur, naturally shall negotiate and agree to solution.

2. General Information

ITEM	STANDARD VALUES	UNITS
LCD type	4.3" TFT	--
Dot arrangement	480(RGB)×272	dots
Color filter array	RGB vertical stripe	--
Display mode	TN / Transmission / Normally White	-
Gray Scale Inversion Direction	12 O'clock	
Eyes Viewing Direction	6 O'clock	--
Driver IC	ST7282	--
Module size	105.5(W)×67.2(H)×3.0(T)	mm
Active area	95.04(W)×53.86(H)	mm
Dot pitch	0.198 (W)×0.198 (H)	mm
Interface	24-bit Parallel RGB Interface	--
Operating temperature	-20 ~ +70	°C
Storage temperature	-30 ~ +80	°C
Back Light	7 White LEDS	--

4. Interface Description

PIN NO.	PIN NAME	DESCRIPTION
1	LEDK	LED backlight (Cathode).
2	LEDA	LED backlight (Anode).
3	GND	Ground for logic.
4	VDD	Power supply for voltage
5-12	R0-R7	Red Data.
13-20	G0-G7	Green Data.
21-28	B0-B7	Blue Data.
29	GND	Ground for logic.
30	PCLK	Dot clock signal input. Latching input data at its rising edge.
31	DISP	Display on/off.
32	HSYNC	Horizontal sync input. Negative polarity.
33	VSYNC	Vertical sync input. Negative polarity.
34	DE	Data enable input. Active high to enable the input data bus.
35	NC	No connection
36	GND	Ground for logic.
37	NC	No connection
38	NC	No connection
39	NC	No connection
40	NC	No connection

5. Absolute Maximum Ratings

Item	Symbol	Min.	Max.	Unit
Logic Supply Voltage	VDD	-0.3	4.0	V
Input Voltage	V _{in}	-0.3	VDD+0.3	V
Operating Temperature	T _{OP}	-20	70	°C
Storage Temperature	T _{ST}	-30	80	°C
Storage Humidity	HD	20	90	%RH

6. DC Characteristics

Item	Symbol	Min.	Typ.	Max.	Unit	Remark
Logic Supply Voltage	VDD	3.0	3.3	3.6	V	-
Input High Voltage	V _{IH}	0.8*VDD	-	VDD	V	-
Input Low Voltage	V _{IL}	GND	-	0.2* VDD	V	-
Output High Voltage	V _{OH}	0.9*VDD	-	VDD	V	-
Output Low Voltage	V _{OL}	GND	-	0.1*VDD	V	-
I/O Leak Current	I _{LI}	-1	-	1	uA	-

7. Timing Characteristics

7.1.1 Power on sequence

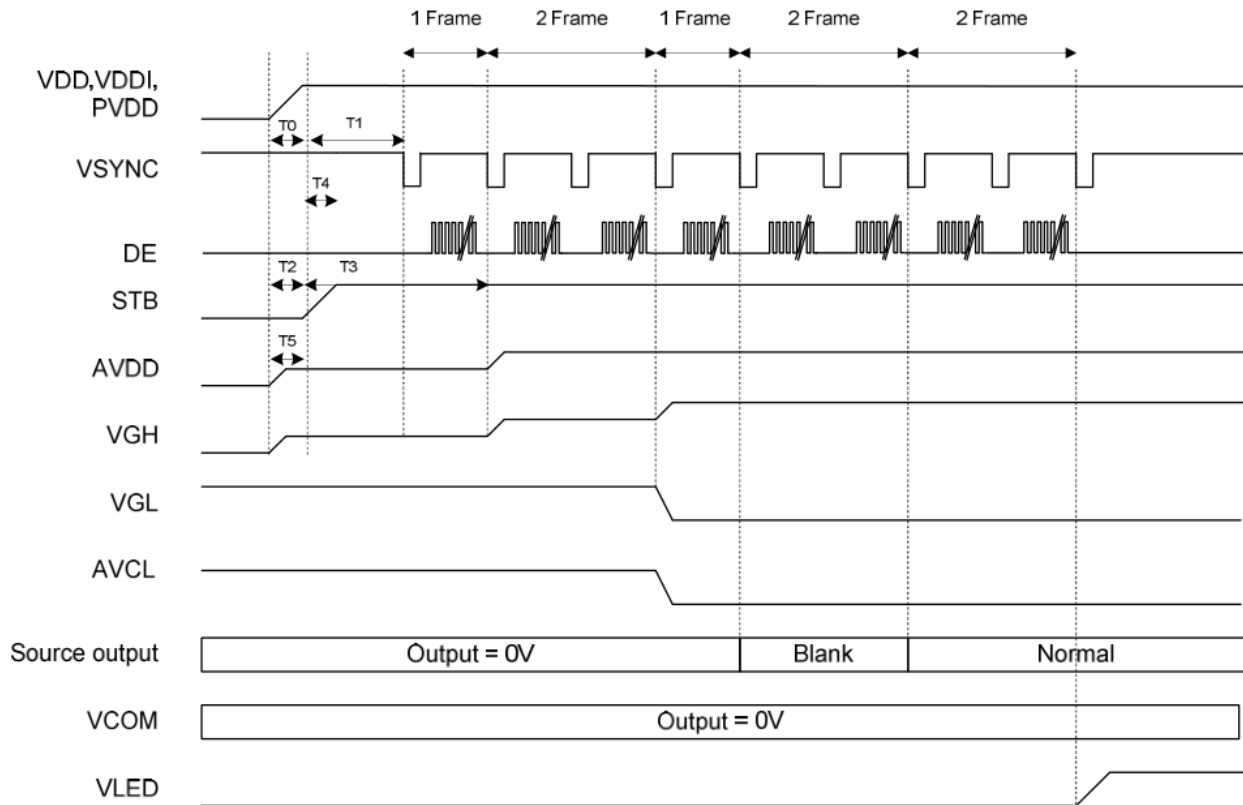

	Description	Min. Time
T0	Determined by the external power	
T1	Time from stable VDD, VDDI, PVDD set-up to the first VSYNC	T1=0
T2	Time from AVDD=0V to AVDD=3.3V	T2=T0
T3	Time from AVDD=3.3V to AVDD=6.0V	T3=T1+ (1*Frame)
T4	Time from stable VDD, VDDI, PVDD set-up to DISP asserted	T4=0
T5	Time from VGH=0V to VGH=3.3V	T5=T0

7.1.2 Power off sequence

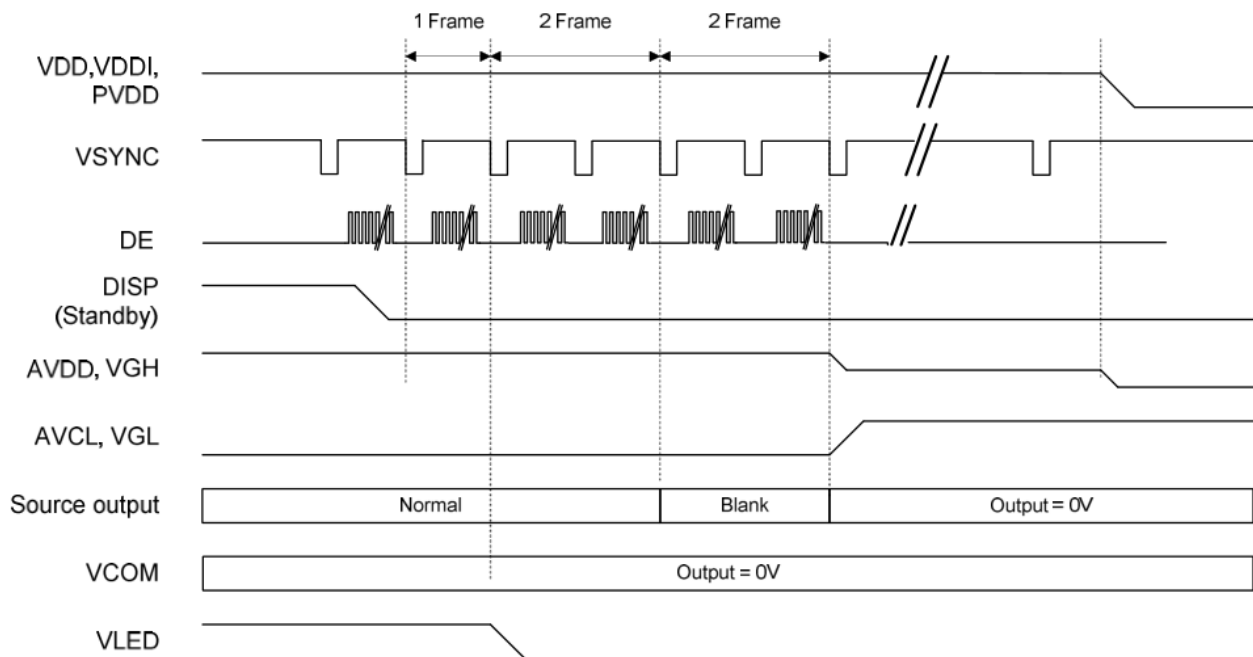

7.2 Parallel 24-bit RGB Timing Table

Item	Symbol	Min.	Typ.	Max.	Unit	Remark
DCLK Frequency	Fclk	8	9	12	MHz	
DCLK Period	Tclk	83	111	125	ns	
HSYNC	Period Time	Th	485	531	DCLK	
	Display Period	Thdisp		480	DCLK	
	Back Porch	Thbp	3	43	DCLK	By H_Blanking setting
	Front Porch	Thfp	2	8	DCLK	
	Pulse Width	Thw	2	4	DCLK	
VSYNC	Period Time	Tv	276	292	H	
	Display Period	Tvdisp		272	H	
	Back Porch	Tvbp	2	12	H	By V_Blanking setting
	Front Porch	Tvfp	2	8	H	
	Pulse Width	Tvw	2	4	H	

7.3 SYNC Mode Timing Diagram

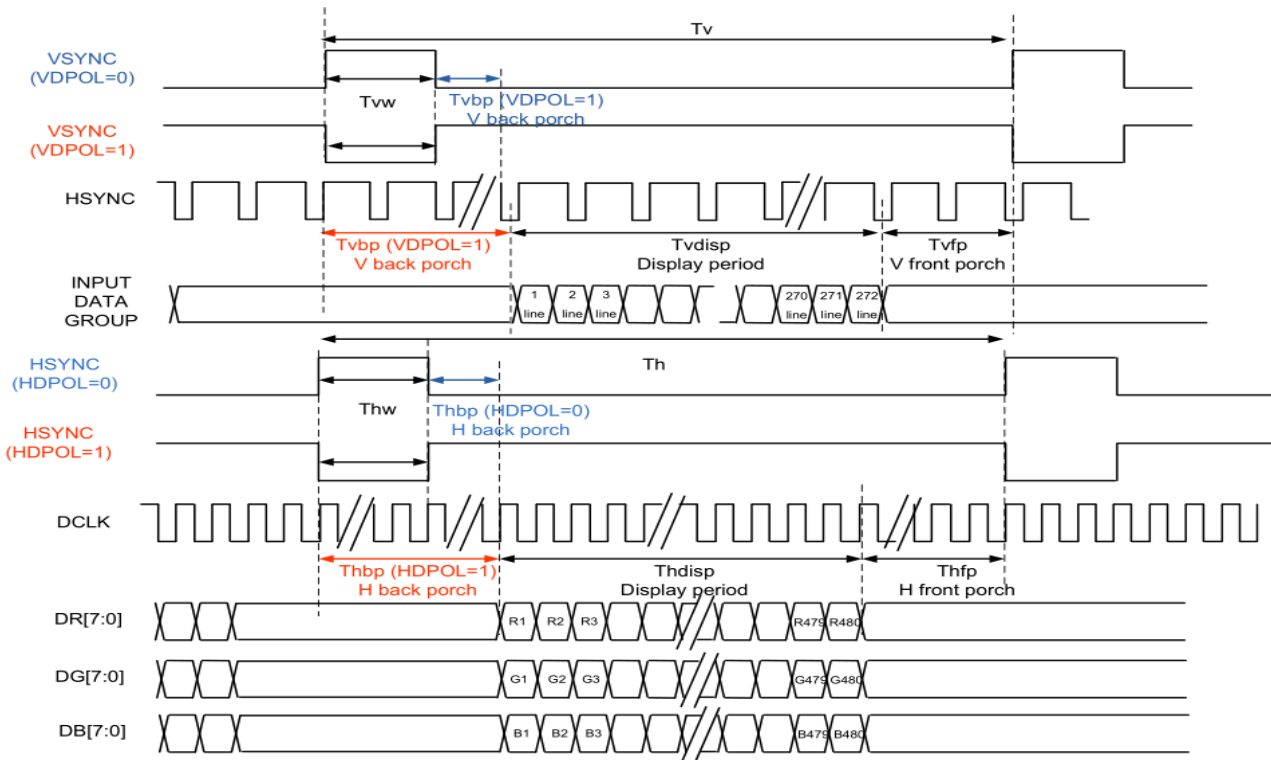

7.4 SYNC-DE Mode Timing Diagram

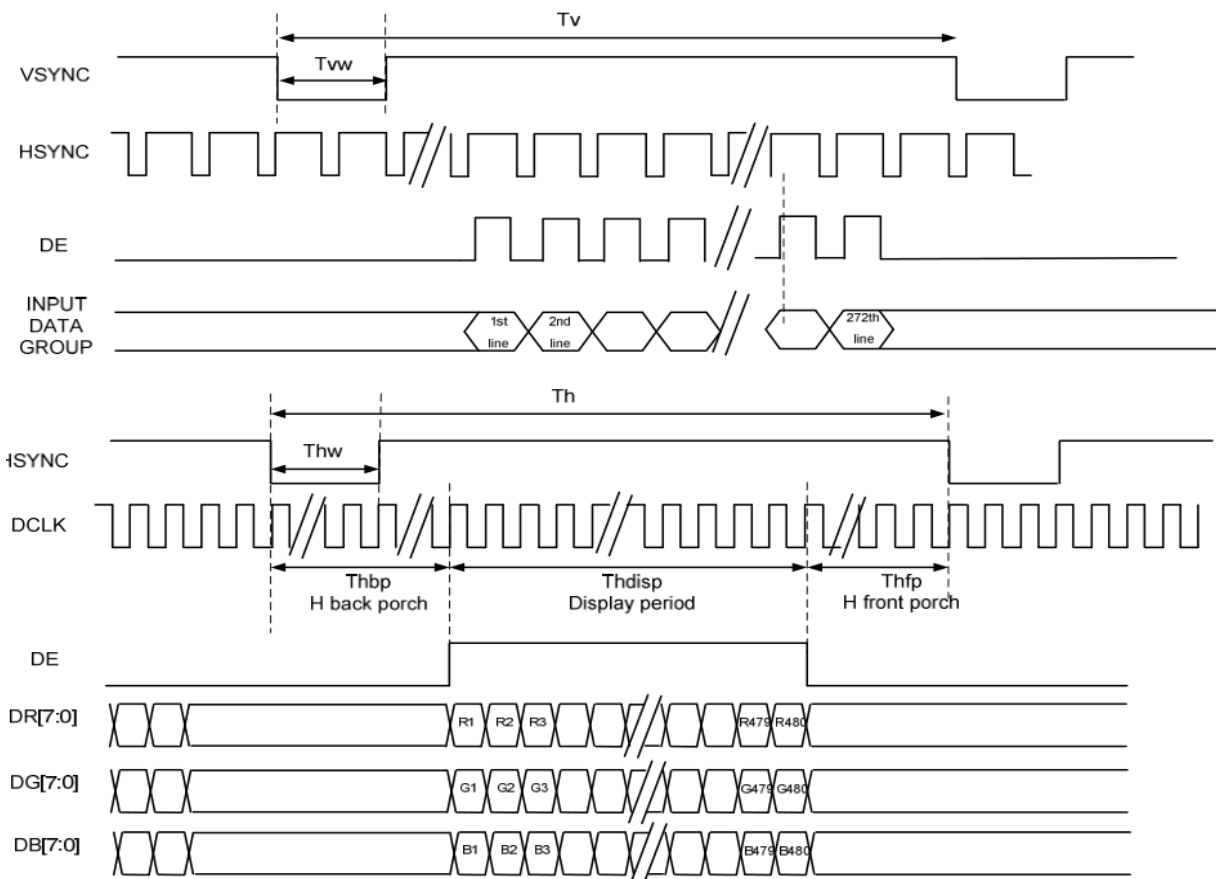

7.5 DE Mode Timing Diagram

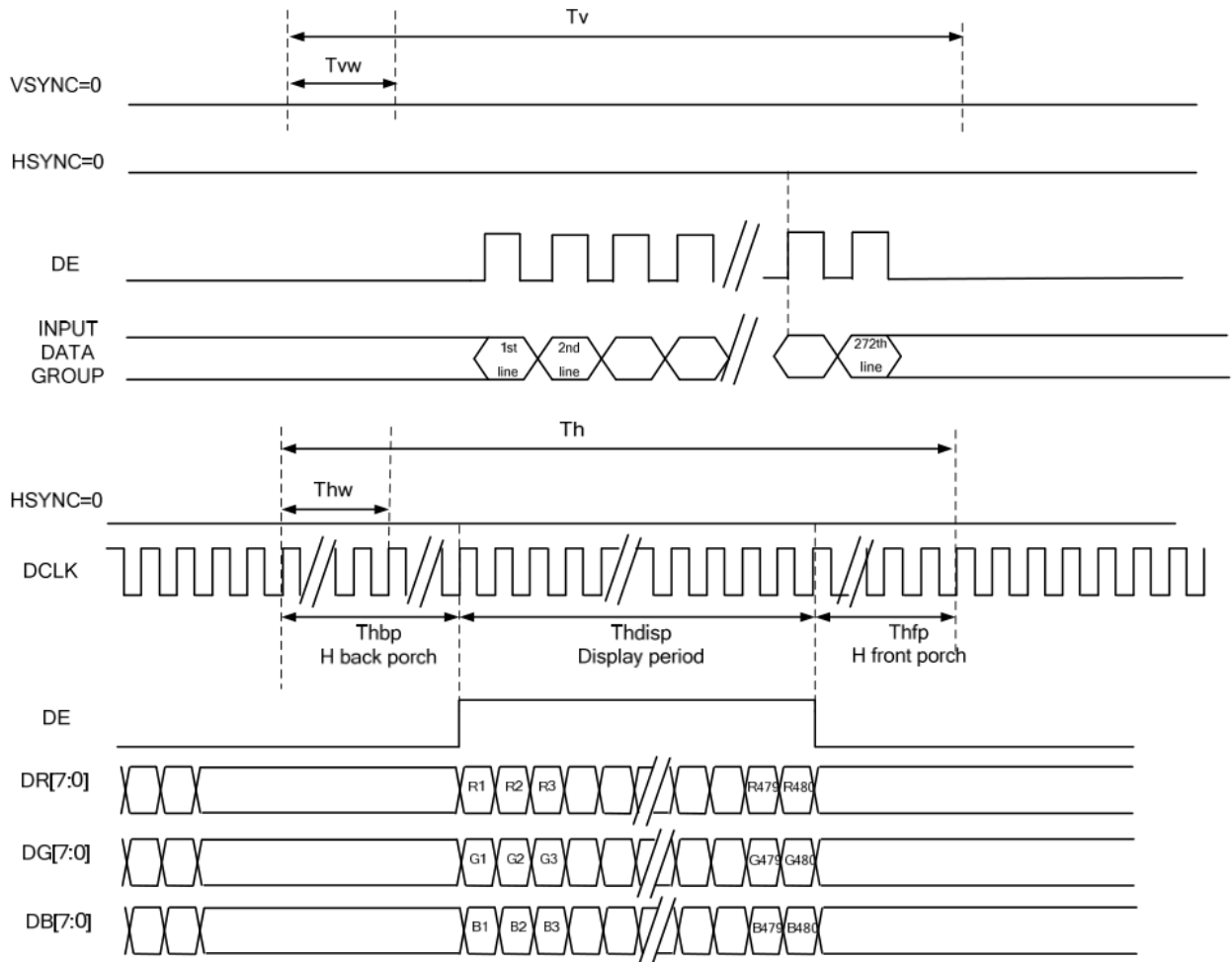

8. Backlight Characteristic

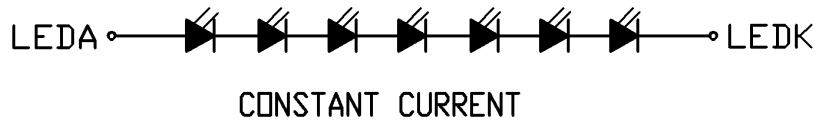

Item	Symbol	MIN	TYP	MAX	UNIT	Test Condition
Supply Voltage	Vf	21	22.4	25.2	V	If=20mA
Supply Current	If	-	20	-	mA	-
Luminous Intensity for LCM	-	250	300	-	cd/m ²	If=20mA
Uniformity for LCM	-	80	-	-	%	If=20mA
Life Time	-	20000	-	-	Hr	If=20mA
Backlight Color	White					

9. Optical Characteristics

Item	Conditions	Min.	Typ.	Max.	Unit	Note	
Viewing Angle (CR>10)	Horizontal	θ_L	60	70	-	degree	(1),(2),(6)
		θ_R	60	70	-		
	Vertical	θ_T	40	50	-		
		θ_B	60	70	-		
Contrast Ratio	Center	400	500	-	-	(1),(3),(6)	
Response Time	Rising	-	25	35	ms	(1),(4),(6)	
	Falling				ms		
CF Color Chromaticity (CIE1931)	Red x	Typ. -0.05	TBD	Typ. +0.05	-	(1), (6)	
	Red y		TBD		-		
	Green x		TBD		-		
	Green y		TBD		-		
	Blue x		TBD		-		
	Blue y		TBD		-		
	White x		TBD		-		
	White y		TBD		-		

Note (1) Measurement Setup: The LCD module should be stabilized at given temp. 25°C for 15 minutes to avoid abrupt temperature change during measuring. In order to stabilize the luminance, the measurement should be executed after lighting backlight for 15 minutes in a windless room.

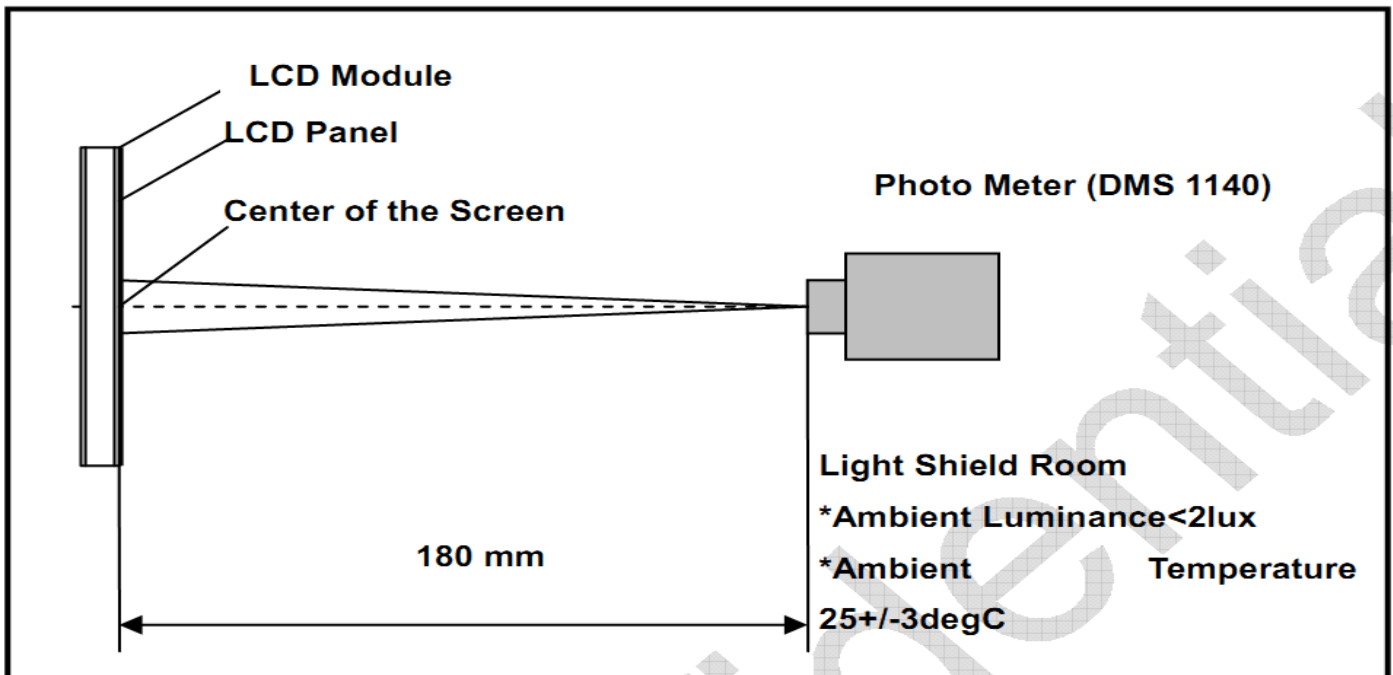

Note (2) Definition of Viewing Angle

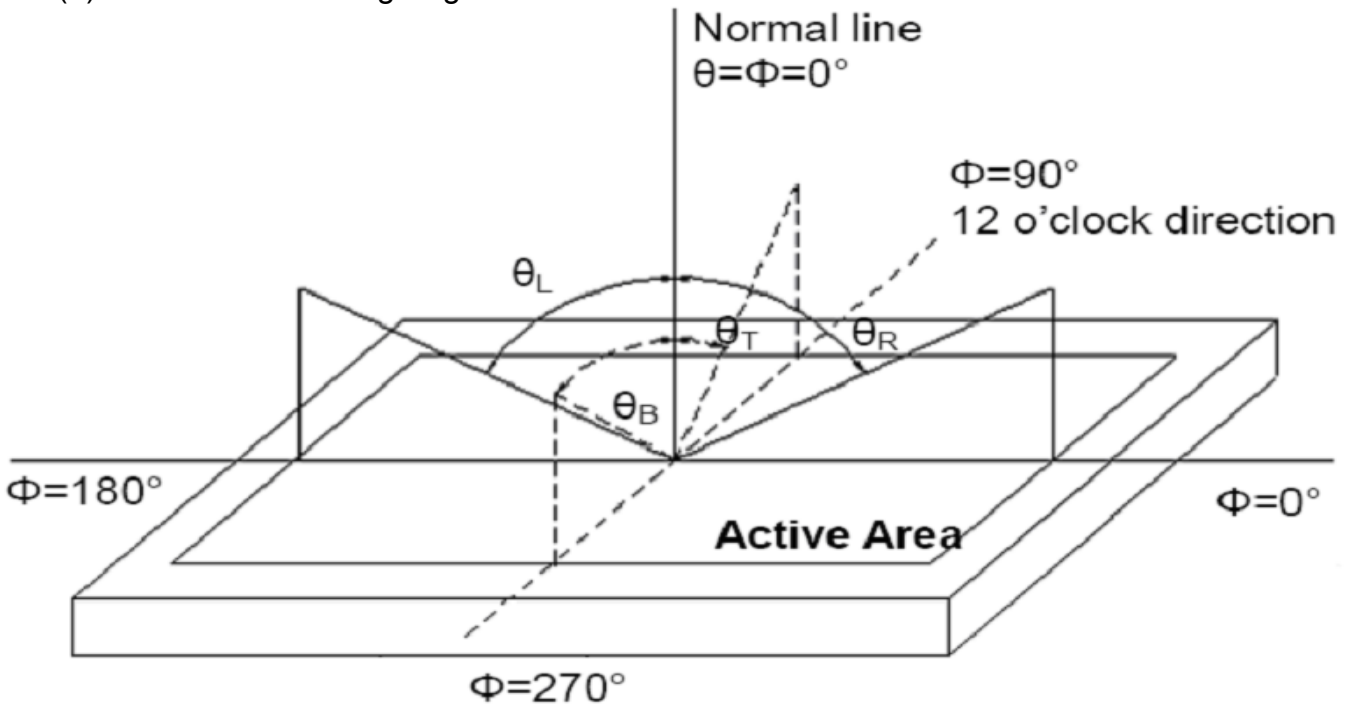

Note (3) Definition of Contrast Ratio (CR)

The contrast ratio can be calculated by the following expression

$$\text{Contrast Ratio (CR)} = L_{63} / L_0$$

L63: Luminance of gray level 63, L0: Luminance of gray level 0

Note (4) Definition of response time

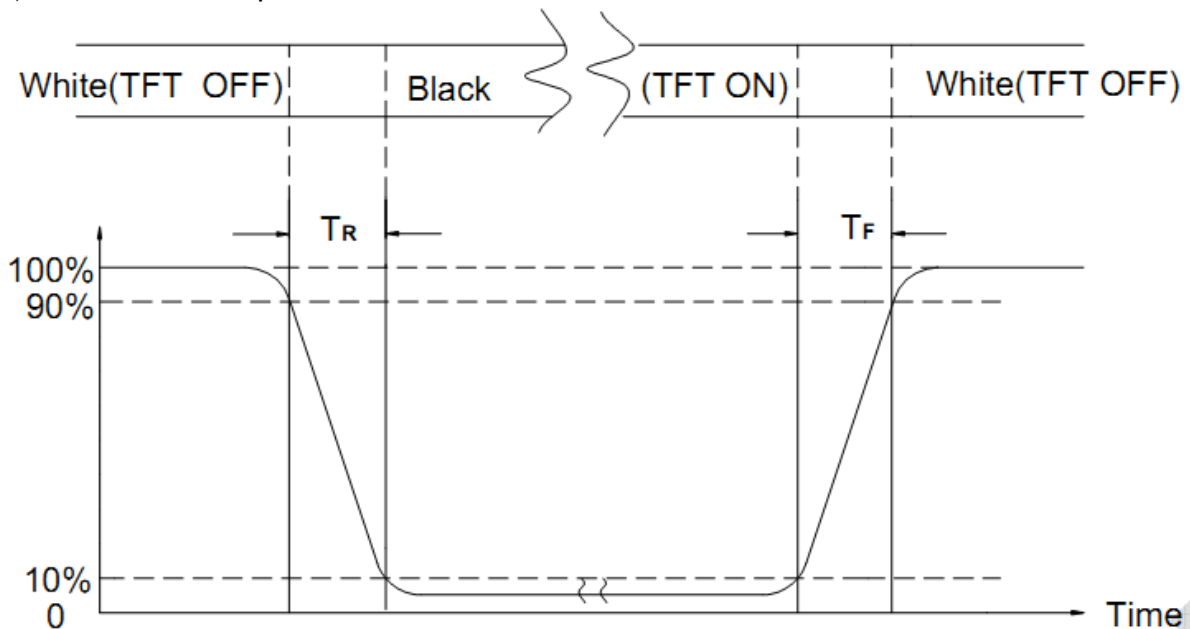

Note (5) Definition of Transmittance (Module is without signal input)

$$\text{Transmittance} = \text{Center Luminance of LCD} / \text{Center Luminance of Back Light} \times 100\%$$

Note (6) Definition of color chromaticity (CIE1931)

Color coordinates measured at the center point of LCD

10. Reliability Test Conditions and Methods

NO.	TEST ITEMS	TEST CONDITION	INSPECTION AFTER TEST
□	High Temperature Storage	80°C±2°C×96Hours	Inspection after 2~4hours storage at room temperature, the samples should be free from defects: 1, Air bubble in the LCD. 2, Seal leak. 3, Non-display. 4, Missing segments. 5, Glass crack. 6, Current IDD is twice higher than initial value. 7, The surface shall be free from damage. 8, The electric characteristic requirements shall be satisfied.
□	Low Temperature Storage	-30°C±2°C×96Hours	
□	High Temperature Operating	70°C±2°C×96Hours	
□	Low Temperature Operating	-20°C±2°C×96Hours	
□	Temperature Cycle(Storage)	-20°C ↔ 25°C ↔ 70°C (30min) ← (5min) → (30min) 1cycle Total 10cycle	
□	Damp Proof Test (Storage)	50°C±5°C×90%RH×96Hours	
□	Vibration Test	Frequency:10Hz~55Hz~10Hz Amplitude:1.5MM X,Y,Z direction for total 3hours (packing condition test will be tested by a carton)	
□	Drooping Test	Drop to the ground from 1M height one time every side of carton. (packing condition test will be tested by a carton)	
□	ESD Test	Voltage:±8KV,R:330Ω,C:150PF,Air Mode,10times	

REMARK:

- 1, The Test samples should be applied to only one test item.
- 2, Sample side for each test item is 5~10pcs.
- 3,For Damp Proof Test, Pure water(Resistance > 10MΩ)should be used.
- 4,In case of malfunction defect caused by ESD damage, if it would be recovered to normal state after resetting, it would be judge as a good part.
- 5, EL evaluation should be accepted from reliability test with humidity and temperature: Some defects such as black spot/blemish can happen by natural chemical reaction with humidity and Fluorescence EL has.
- 6, Failure Judgment Criterion: Basic Specification Electrical Characteristic, Mechanical Characteristic, Optical Characteristic.

11. Inspection Standard

11.1 Incoming Inspection and Standard:

The below incoming inspection are applied to the TFT LCM Modules supplied by AMSON Optoelectronic Industry CO.,LTD. The customers should inspect the LCM within 14 days after receiving the goods. The result of inspection should be notified to the Seller in the writing copy promptly, if the customer do not send them within 14 days, the seller has the right to judge as acceptance of goods. The inspection lot size is treated as the quantity per shipment and per model. The sampling plan shall be inspected under MIL-STD015E in Level II by single sampling. The acceptable quality level (AQL) are categorized as below grades:

CRITICAL= 0.65%, MAJOR= 0.65%, MINOR= 1.5%

11.2 Inspection condition and Warranty policy:

The delivered LCM should be stored properly, ideally under climate-controlled environment at 25 (±5) degree Celsius as well as 60% (±10) Relative Humidity. The LCM shall be inspected in the viewing angle of 45 degree from the four major angles (U/D/L/R) under the single fluorescent lamp of 20W (equal to 300 to 500 lux). For warranty, AMSON Optoelectronic Industry CO.,LTD. will provide 12 months of warranty period as standard, and provide the new replacement for the defective products which belong to the Seller's responsibility verified by the quality department.

11.3 Inspection Criteria:

11.3.1 Critical defect (重度缺失)

Item No.	Inspection content	Judgement
11.3.1.1	Functional defects	No display, abnormal display, short circuit, missing line, off-contrast and chromaticity, Touch Panel non-function
11.3.1.2	Model mixed	Other model mixed

11.3.2 Major defect: (主要缺失)

Item No.	Inspection content	Judgement
11.3.2.1	Product indication	Missing model no. and wrong model no. is indicated on the LCM.

11.3.2.2	Glass cracking	The LCD and touch panel glass crack or breakage
11.3.2.3	Missing component	The function component missing such as connector, cable, etc.

11.3.3 Minor defect (LCD) : (次要缺失)

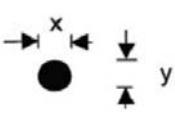
Item No.	Inspection content	Judgement												
11.3.3.1	Black/White spot Foreign particles Dust in the cell	<div style="text-align: center;"> $\phi = (x+y) / 2$  </div> <table border="1" style="width: 100%; margin-top: 10px; border-collapse: collapse;"> <thead> <tr> <th style="width: 50%; padding: 5px;">Diameter (mm)</th> <th style="padding: 5px;">Acceptable Q'ty</th> </tr> </thead> <tbody> <tr> <td style="text-align: center; padding: 5px;">$\Phi \leq 0.1$</td> <td style="text-align: center; padding: 5px;">Ignore</td> </tr> <tr> <td style="text-align: center; padding: 5px;">$0.1 < \Phi \leq 0.25$</td> <td style="text-align: center; padding: 5px;">3 (Distance>5mm)</td> </tr> <tr> <td style="text-align: center; padding: 5px;">$0.25 < \Phi$</td> <td style="text-align: center; padding: 5px;">Not allowed</td> </tr> </tbody> </table>	Diameter (mm)	Acceptable Q'ty	$\Phi \leq 0.1$	Ignore	$0.1 < \Phi \leq 0.25$	3 (Distance>5mm)	$0.25 < \Phi$	Not allowed				
Diameter (mm)	Acceptable Q'ty													
$\Phi \leq 0.1$	Ignore													
$0.1 < \Phi \leq 0.25$	3 (Distance>5mm)													
$0.25 < \Phi$	Not allowed													
11.3.3.2	Linear defect Black/white line Black/white scratch	<table border="1" style="width: 100%; margin-top: 10px; border-collapse: collapse;"> <thead> <tr> <th style="width: 33%; padding: 5px;">Length(mm)</th> <th style="width: 33%; padding: 5px;">Width (mm)</th> <th style="padding: 5px;">Acceptable Q'ty</th> </tr> </thead> <tbody> <tr> <td style="padding: 5px;"></td> <td style="text-align: center; padding: 5px;">$W \leq 0.03$</td> <td style="text-align: center; padding: 5px;">Ignore</td> </tr> <tr> <td style="text-align: center; padding: 5px;">$L \leq 5.0$</td> <td style="text-align: center; padding: 5px;">$0.03 < W \leq 0.07$</td> <td style="text-align: center; padding: 5px;">3</td> </tr> <tr> <td style="padding: 5px;"></td> <td style="text-align: center; padding: 5px;">$0.07 < W$</td> <td style="text-align: center; padding: 5px;">Follow 11.3.3.1</td> </tr> </tbody> </table>	Length(mm)	Width (mm)	Acceptable Q'ty		$W \leq 0.03$	Ignore	$L \leq 5.0$	$0.03 < W \leq 0.07$	3		$0.07 < W$	Follow 11.3.3.1
Length(mm)	Width (mm)	Acceptable Q'ty												
	$W \leq 0.03$	Ignore												
$L \leq 5.0$	$0.03 < W \leq 0.07$	3												
	$0.07 < W$	Follow 11.3.3.1												

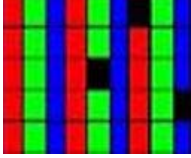
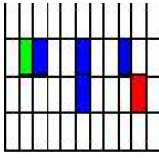
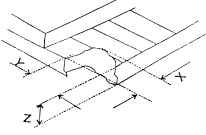
<p>11.3.3.3</p>	<p>Polarizer Bubbles Dent on polarizer</p>	<table border="1"> <thead> <tr> <th>Diameter (mm)</th> <th>Acceptable Q'ty</th> </tr> </thead> <tbody> <tr> <td>$\Phi \leq 0.2$</td> <td>Ignore</td> </tr> <tr> <td>$0.2 < \Phi \leq 0.5$</td> <td>2 (Distance>5mm)</td> </tr> <tr> <td>$0.5 < \Phi$</td> <td>Not allowed</td> </tr> </tbody> </table>	Diameter (mm)	Acceptable Q'ty	$\Phi \leq 0.2$	Ignore	$0.2 < \Phi \leq 0.5$	2 (Distance>5mm)	$0.5 < \Phi$	Not allowed
Diameter (mm)	Acceptable Q'ty									
$\Phi \leq 0.2$	Ignore									
$0.2 < \Phi \leq 0.5$	2 (Distance>5mm)									
$0.5 < \Phi$	Not allowed									
<p>11.3.3.4</p>	<p>Electrical Defect Dot</p>	<p>Bright dot and Dark dot definition:</p>  <p>or</p>   <p>(Two adjacent dot)</p> <p>Inspection pattern: black, white, red, green, and blue screen.</p> <table border="1"> <thead> <tr> <th>Items</th> <th>Acceptable Q'ty</th> </tr> </thead> <tbody> <tr> <td>Bright dot</td> <td>$N \leq 4$ (Distance >5mm)</td> </tr> <tr> <td>Dark dot</td> <td>$N \leq 4$ (Distance >5mm)</td> </tr> </tbody> </table>	Items	Acceptable Q'ty	Bright dot	$N \leq 4$ (Distance >5mm)	Dark dot	$N \leq 4$ (Distance >5mm)		
Items	Acceptable Q'ty									
Bright dot	$N \leq 4$ (Distance >5mm)									
Dark dot	$N \leq 4$ (Distance >5mm)									
<p>11.3.3.5</p>	<p>Glass Defect- Corner chipping</p>	 <table border="1"> <thead> <tr> <th>Size(mm)</th> <th>Judgement</th> </tr> </thead> <tbody> <tr> <td> $X \leq 3\text{mm}, Y \leq S,$ $Z \leq T$ (S= ITO length, T=Single glass thickness) </td> <td>Accept</td> </tr> </tbody> </table>	Size(mm)	Judgement	$X \leq 3\text{mm}, Y \leq S,$ $Z \leq T$ (S= ITO length, T=Single glass thickness)	Accept				
Size(mm)	Judgement									
$X \leq 3\text{mm}, Y \leq S,$ $Z \leq T$ (S= ITO length, T=Single glass thickness)	Accept									

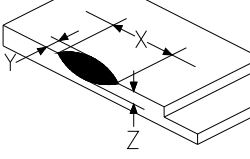
<p>11.3.3.6</p>	<p>Glass Defect- Side fragment</p>	 <table border="1" data-bbox="703 434 1410 810"> <thead> <tr> <th data-bbox="703 434 1010 512">Size(mm)</th> <th data-bbox="1013 434 1410 512">Judgement</th> </tr> </thead> <tbody> <tr> <td data-bbox="703 517 1010 810"> $X \leq 2 \text{ mm}$, $Y \leq \text{border edge}$ $Z \leq T$ (T= single glass thickness) </td> <td data-bbox="1013 517 1410 810"> <p>Accept</p> </td> </tr> </tbody> </table>	Size(mm)	Judgement	$X \leq 2 \text{ mm}$, $Y \leq \text{border edge}$ $Z \leq T$ (T= single glass thickness)	<p>Accept</p>
Size(mm)	Judgement					
$X \leq 2 \text{ mm}$, $Y \leq \text{border edge}$ $Z \leq T$ (T= single glass thickness)	<p>Accept</p>					

12. Handling Precautions

12.1 Mounting method

The LCD panel of AMSON TFT module consists of two thin glass plates with polarizers which easily be damaged. And since the module is so constructed as to be fixed by utilizing fitting holes in the printed circuit board.

Extreme care should be needed when handling the LCD modules.

12.2 Caution of LCD handling and cleaning

When cleaning the display surface, Use soft cloth with solvent

[Recommended below] and wipe lightly

- Isopropyl alcohol
- Ethyl alcohol

Do not wipe the display surface with dry or hard materials that will damage the polarizer surface.

Do not use the following solvent:

- Water
- Aromatics

Do not wipe ITO pad area with the dry or hard materials that will damage the ITO patterns

Do not use the following solvent on the pad or prevent it from being contaminated:

- Soldering flux
- Chlorine (Cl) , Sulfur (S)

If goods were sent without being silicon coated on the pad, ITO patterns could be damaged due to the corrosion as time goes on.

If ITO corrosion happens by miss-handling or using some materials such as Chlorine (Cl), Sulfur (S) from customer, Responsibility is on customer.

12.3 Caution against static charge

The LCD module uses C-MOS LSI drivers, so we recommend that you:

Connect any unused input terminal to power or ground, do not input any signals before power is turned on, and ground your body, work/assembly areas, and assembly equipment to protect against static electricity.

12.4 packing

- Module employs LCD elements and must be treated as such.
- Avoid intense shock and falls from a height.
- To prevent modules from degradation, do not operate or store them exposed directly to sunshine or high temperature/humidity

12.5 Caution for operation

- It is an indispensable condition to drive LCD's within the specified voltage limit since the higher voltage than the limit causes the shorter LCD life.
- An electrochemical reaction due to direct current causes LCD's undesirable deterioration, so that the use of direct current drive should be avoided.
- Response time will be extremely delayed at lower temperature than the operating temperature range and on the other hand at higher temperature LCD's show dark color in them. However those phenomena do not mean malfunction or out of order with LCD's, which will come back in the specified operation temperature.
- If the display area is pushed hard during operation, some font will be abnormally displayed but it resumes normal condition after turning off once.
- Slight dew depositing on terminals is a cause for electro-chemical reaction resulting in terminal open circuit.

Usage under the maximum operating temperature, 50%Rh or less is required.

12.6 storing

In the case of storing for a long period of time for instance, for years for the purpose or replacement use, the following ways are recommended.

- Storage in a polyethylene bag with the opening sealed so as not to enter fresh air outside in it. And with no desiccant.
- Placing in a dark place where neither exposure to direct sunlight nor light's keeping the storage temperature range.
- Storing with no touch on polarizer surface by the anything else.
[It is recommended to store them as they have been contained in the inner container at the time of delivery from us

12.7 Safety

- It is recommendable to crash damaged or unnecessary LCD's into pieces and wash off liquid crystal by either of solvents such as acetone and ethanol, which should be burned up later.
- When any liquid leaked out of a damaged glass cell comes in contact with your hands, please wash it off well with soap and water

13. Precaution for Use

13.1

A limit sample should be provided by the both parties on an occasion when the both parties agreed its necessity. Judgment by a limit sample shall take effect after the limit sample has been established and confirmed by the both parties.

13.2

On the following occasions, the handing of problem should be decided through discussion and agreement between responsible of the both parties.

- When a question is arisen in this specification
- When a new problem is arisen which is not specified in this specifications
- When an inspection specifications change or operating condition change in customer is reported to AMSON TFT , and some problem is arisen in this specification due to the change
- When a new problem is arisen at the customer's operating set for sample evaluation in the customer site.

14. Packing Method

TBD