

Specification for Approval

Customer: _____

Model Name: _____

Supplier Approval			Customer approval
R&D Designed	R&D Approved	QC Approved	
<i>Peter</i>	<i>Peng Jun</i>		

Table of Contents

List	Description	Page No.
	Cover	1
	Revision Record	2
	Table of Contents	3
1	Scope	4
2	General Information	4
3	External Dimensions	5
4	Interface Description	6
5	Absolute Maximum Ratings	6
6	Electrical Characteristics	7
7	Timing Characteristics	7
8	Backlight Characteristics	10
9	Touch Panel Characteristics	11
10	Optical Characteristics	12
11	Reliability Test Conditions and Methods	14
12	Inspection Standard	15
13	Handling Precautions	18
14	Precaution for Use	19
15	Packing Method	20

1. Scope

This specification defines general provisions as well as inspection standards for TFT module supplied by AMSON electronics.

If the event of unforeseen problem or unspecified items may occur, naturally shall negotiate and agree to solution.

2. General Information

ITEM	STANDARD VALUES	UNITS
LCD type	5.0" TFT	--
Dot arrangement	800(RGB) × 480	dots
Color filter array	RGB vertical stripe	--
Display mode	TN / Transmission / Normally White	--
Viewing Direction	6 o'clock (Gray scale inversion)	--
Module size	120.80(W) × 75.90(H) × 4.20(T)	mm
Active area	108.0(W) × 64.8(H)	mm
Dot pitch	0.135(W) × 0.135(H)	mm
Interface	24-bit Parallel RGB Interface	--
Operating temperature	-20 ~ +70	°C
Storage temperature	-30 ~ +80	°C
Back Light	12 White LED	--
Weight	TBD	g

4. Interface Description

Pin	Symbol	Description.
1	LEDK	LED backlight (Cathode).
2	LEDA	LED backlight (Anode).
3	GND	Ground.
4	VDD	Power supply.
5~12	R0~R7	Red Data.
13~20	G0~G7	Green Data.
21~28	B0~B7	Blue Data.
29	GND	Ground.
30	DCLK	Clock.
31	DISP	Display on/off.
32	HSD	Horizontal sync input in RGB mode.
33	VSD	Vertical sync input in RGB mode.
34	DE	Data input Enable.
35	NC	No connection.
36	GND	Ground.
37	XR	TP Right.
38	YD	TP Bottom.
39	XL	TP Left.
40	YU	TP Up.

5. Absolute Maximum Ratings

Item	Symbol	Min.	Max.	Unit
Logic Supply Voltage	VDD	-0.3	5.0	V
Input Voltage	VIN	0	VDD	V
Operating Temperature	TOP	-20	70	°C
Storage Temperature	TST	-30	80	°C
Storage Humidity	HD	20	90	%RH

6. DC Characteristics

Item	Symbol	Min.	Typ.	Max.	Unit	Remark
Power Supply Voltage	VDD	2.3	3.3	3.6	V	-
Input High Voltage	V _{IH}	0.7VDD	--	VDD	V	Digital input pins
Input Low Voltage	V _{IL}	GND	--	0.3VDD	V	Digital input pins
Output High Voltage	V _{OH}	VDD-0.4	--	VDD	V	Digital output pins
Output Low Voltage	V _{OL}	GND	--	GND+0.4	V	Digital output pins
I/O Leak Current	I _{LI}	--	--	± 1.0	uA	-

7. Timing Characteristics

7.1 Power ON/OFF Sequence

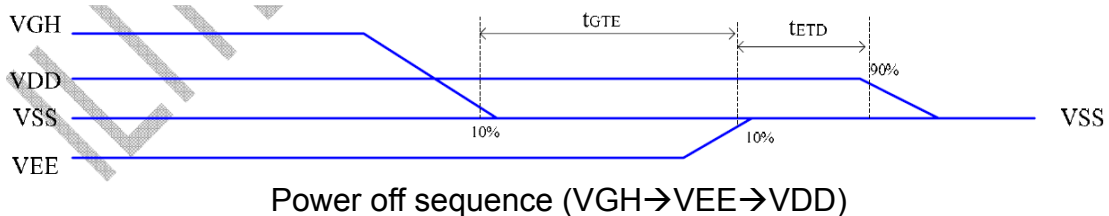
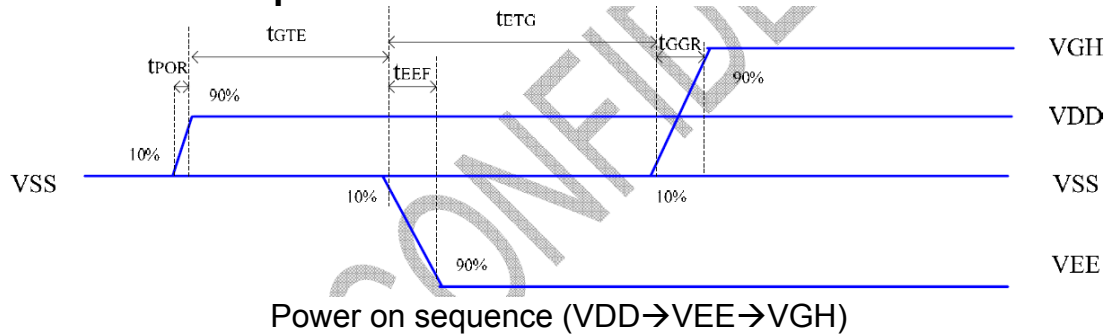

7.2 Timing Diagram of interface Signal Parallel 24-bit RGB Mode

Parameter	Symbol	Min.	Typ.	Max.	Unit	Conditions
CLKIN Frequency	Fclk	-	40	50	MHz	VDD = 3.0V ~3.6V
CLKIN Cycle Time	Tclk	20	25	-	ns	
CLKIN Pulse Duty	Tcwh	40	50	60	%	Tclk
Time from HSD to Source Output	Thso	-	64	-	CLKIN	
Time from HSD to LD	Thld	-	64	-	CLKIN	
Time from HSD to STV	Thstv	-	2	-	CLKIN	
Time from HSD to CKV	Thckv	-	20	-	CLKIN	
Time from HSD to OEV	Thoev	-	4	-	CLKIN	
LD Pulse Width	Twld	-	10	-	CLKIN	
CKV Pulse Width	Twckv	-	66	-	CLKIN	
OEV Pulse Width	Twoev	-	74	-	CLKIN	

Input Clock and Data Timing Diagram

DE Mode

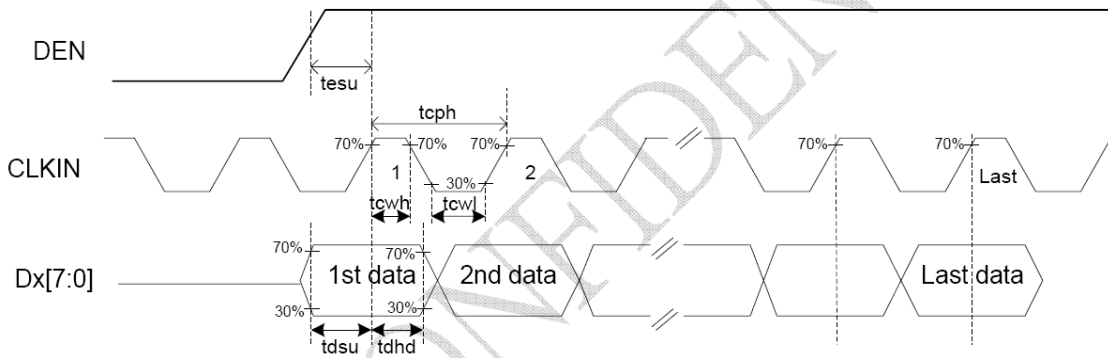

HV Mode

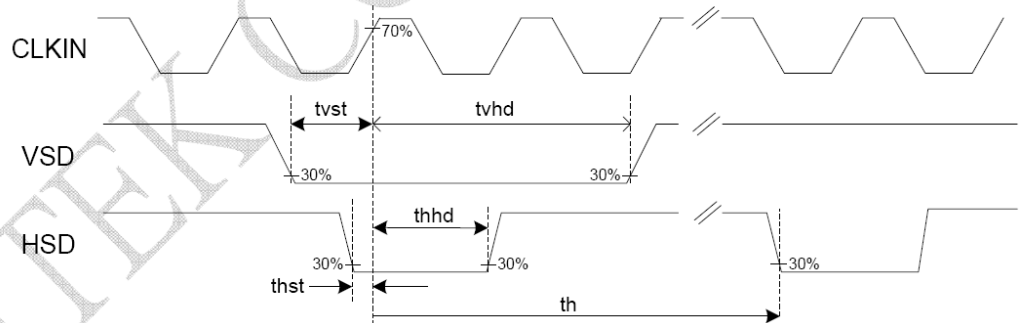

Source output timing diagram

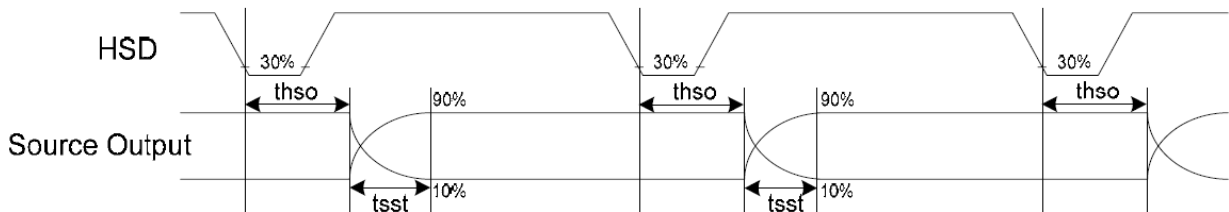

Output Loading condition

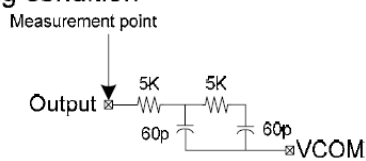

Vertical Timing Diagram of HV Mode (Dual Gate)

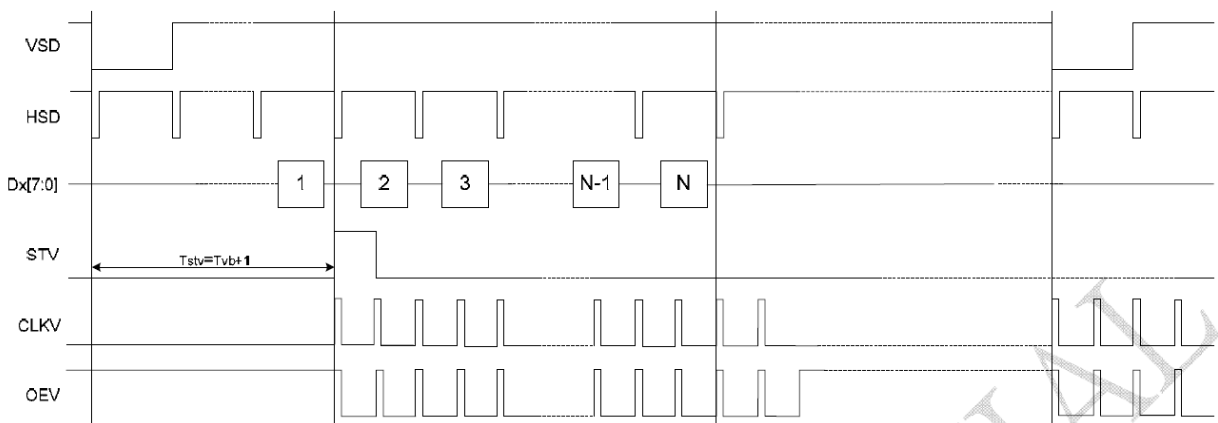

Vertical Timing Diagram of DE Mode (Dual Gate)

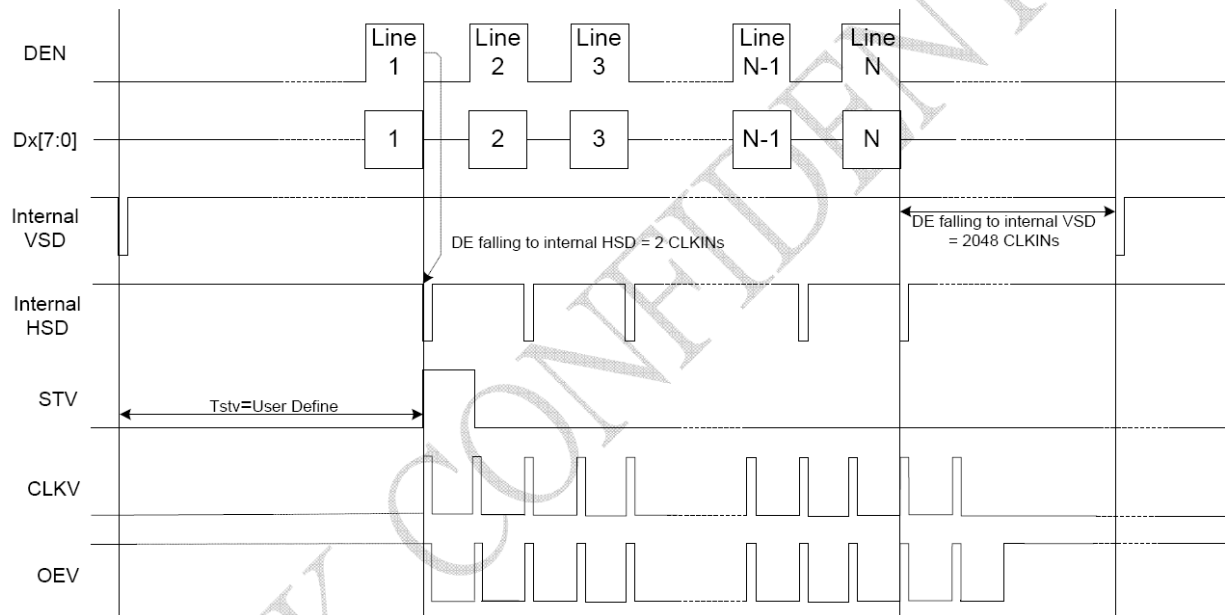

Gate Output Timing Diagram (Dual Gate)

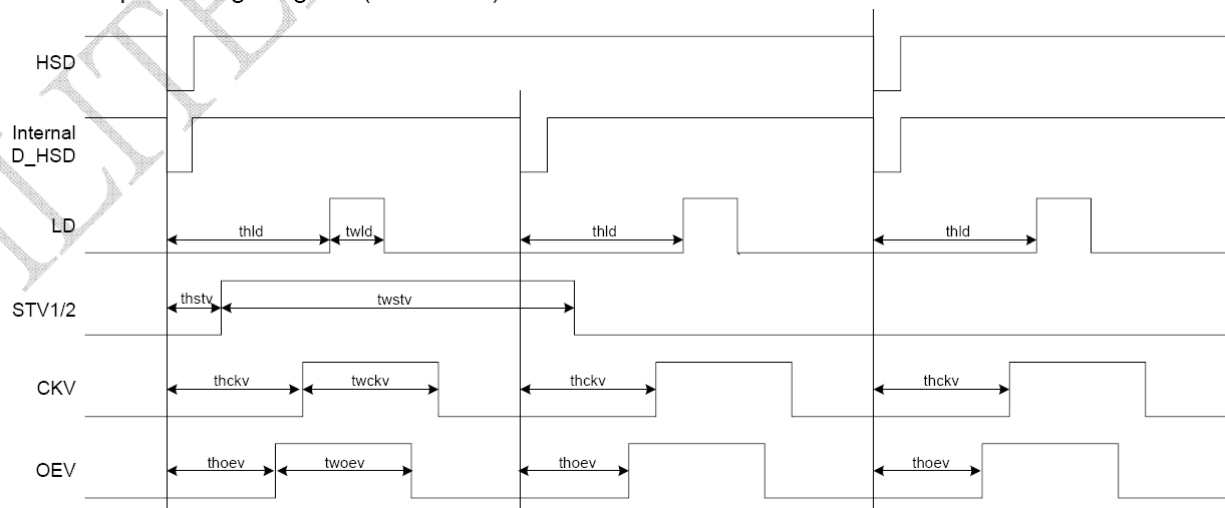

Vertical Timing Diagram of HV Mode (Cascade)

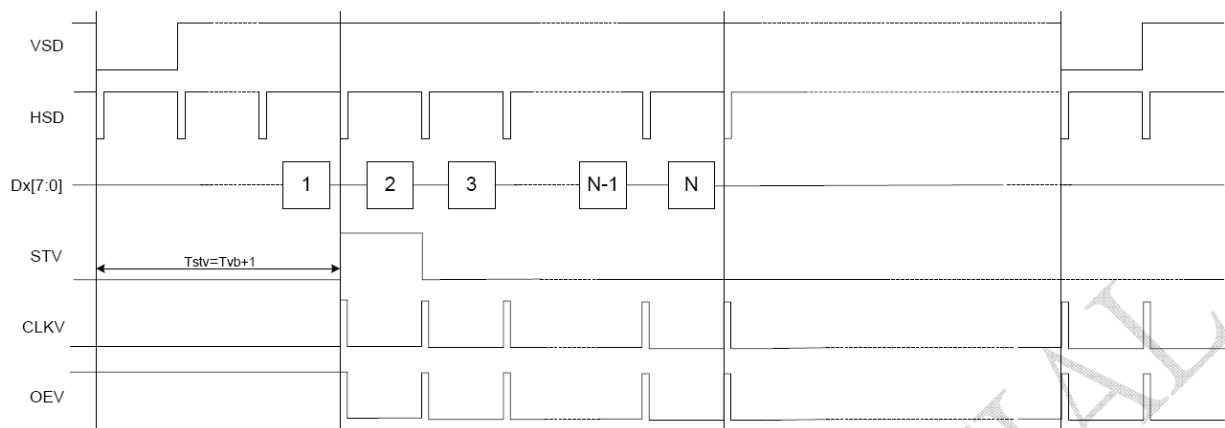

Vertical Timing Diagram of DE Mode (Cascade)

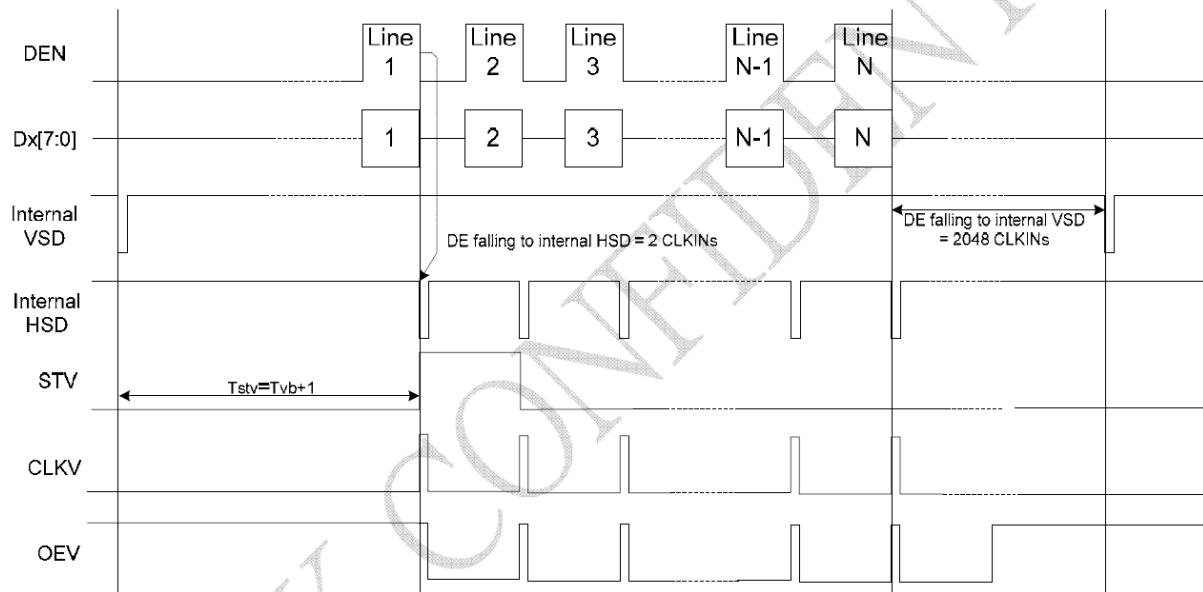

Gate Output Timing Diagram (Cascade)

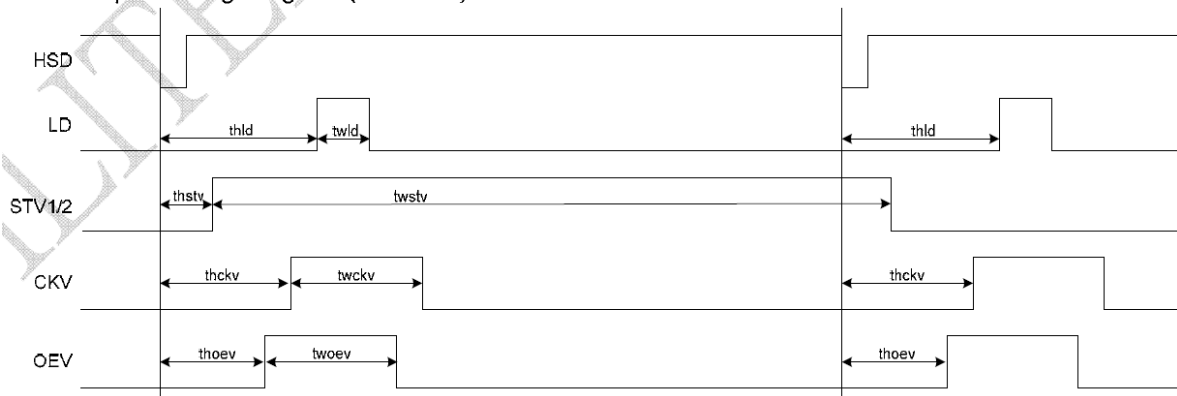

8. Backlight Characteristics

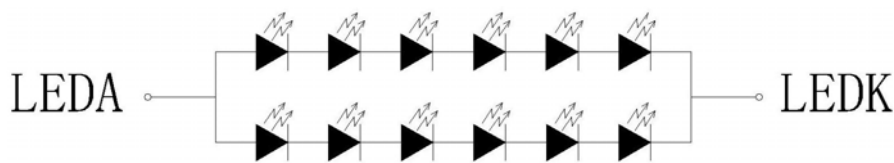

BL CIRCUIT DIAGRAM
 $V_f = 19.8V, I_f = 40mA$

Item	Symbol	MIN	TYP	MAX	UNIT	Test Condition
Supply Voltage	V_f	18.0	19.8	21.0	V	$I_f = 40mA$
Supply Current	I_f	--	40	50	mA	--
Luminous Intensity for LCM (With TP)	--	320	400	--	Cd/m^2	$I_f = 40mA$
Uniformity for LCM	--	80	--	--	%	$I_f = 40mA$
Life Time	--	50000	--	--	Hr	$I_f = 40mA$
Backlight Color	White					

9. Touch Panel Characteristics

9.1 General Standard Specification

Item	Specification
Input Method	Finger or Stylus pen
ITO Glass	T=1.10mm, 500±150 Ω/sq
ITO Film	T=0.188mm, 500±150 Ω/sq
Operating Temperature Range	-20°C ~ +70°C 90%RH ↓ (Except for dew gathering)
Storage Temperature Range	-30°C ~ +80°C 90%RH ↓ (Except for dew gathering)
Surface Hardness	3H- pressure 500gf , 45deg.
Hitting Durability	1,000,000 times (pressure 150g , frequency 1 time/s)
Pen Sliding Durability	100,000 times (pressure 150g , speed 60mm/s, 10~100mm)
Light Transparency	77% min.
Activation Force	150gf less individual point on with polyacetal stylus pen (R0.8mm)

9.2 Electrical Characteristic Specification

Item	Specification
Operating Voltage	DC 3~15V
Circuit Resistance	X- axis : 200Ω ~ 1100Ω
	Y- axis : 200Ω ~ 800Ω
Insulation Resistance	>20 MΩ (DC25V 1min)
Chatting	<10ms
Linearity	≤1.5%

10. Optical Characteristics

(Transmittance, contrast, RT, viewing angle results are using CPT LC+ EWV Polarizer+ CPT's BLU (2L1D) reference only) (Note1, Note2)

Item	Symbol	Condition	Min.	Typ.	Max.	Unit	Note
Transmittance (With EWV PZ)	T		—	4.48	—	%	
Contrast	CR		480	600	—		(1)(2)
Response time	Rising	T_R	—	2	4	msec	(1)(3)
	Falling	T_F	—	6	12		
Color gamut	S		—	50	—	%	C light
Color chromaticity (CIE1931)	White	W_x	$\theta=0$ Normal viewing angle	0.295	0.310	0.325	(1)(4) CF Glass C light
		W_y		0.334	0.349	0.364	
	Red	R_x		0.611	0.626	0.641	
		R_y		0.331	0.346	0.361	
	Green	G_x		0.307	0.322	0.337	
		G_y		0.537	0.552	0.567	
	Blue	B_x		0.134	0.149	0.164	
		B_y		0.168	0.183	0.198	
Viewing angle (With EWV PZ)	Hor.	θ_L	$CR>10$	65	75	—	
		θ_R		65	75	—	
	Ver.	θ_U		50	60	—	
		θ_D		60	70	—	
Optima View Direction			6 O' clock				(5)

Measuring Condition:

Dark room, $25\pm 2^\circ\text{C}$, 15min. warm-up time.

Measuring Equipment

FPM520 of Western Display technologies, INC., which utilized SR-3 for Chromaticity and BM-5A for other optical characteristics.

Note (1) Definition of Viewing Angle:

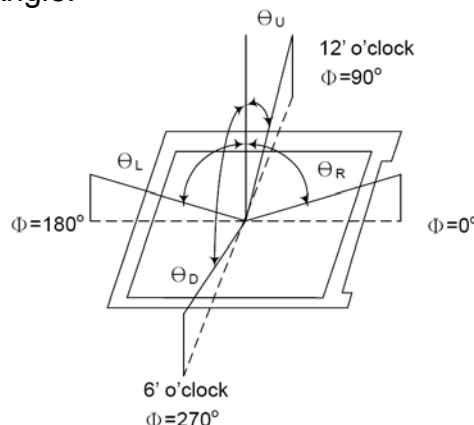

Note (2) Definition of Contrast Ratio (CR): Measured at the center point of panel

CR = Luminance with all pixels white / Luminance with all pixels black

Note (3) Definition of Response Time: Sum of TR and TF

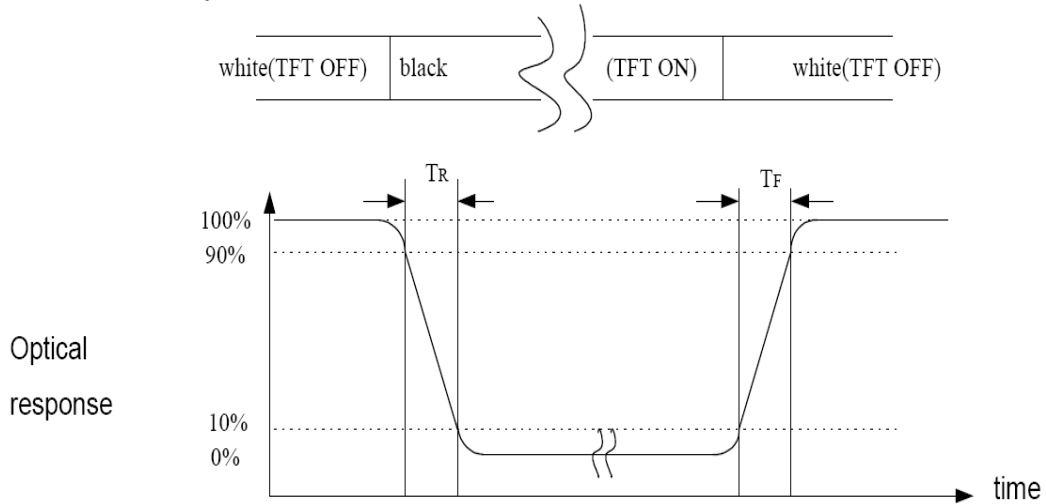

Note (4) Definition of optical measurement setup

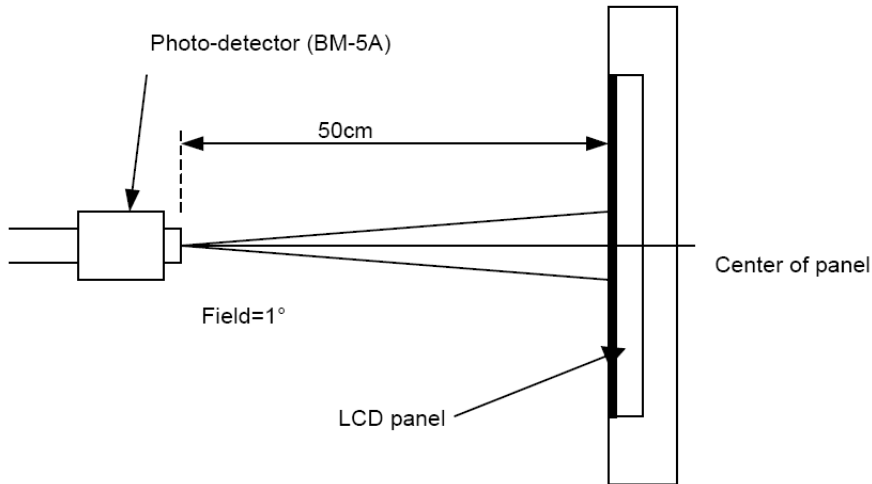

Note (5) Rubbing Direction (The different Rubbing Direction will cause the different optima view direction). TFT Face UP

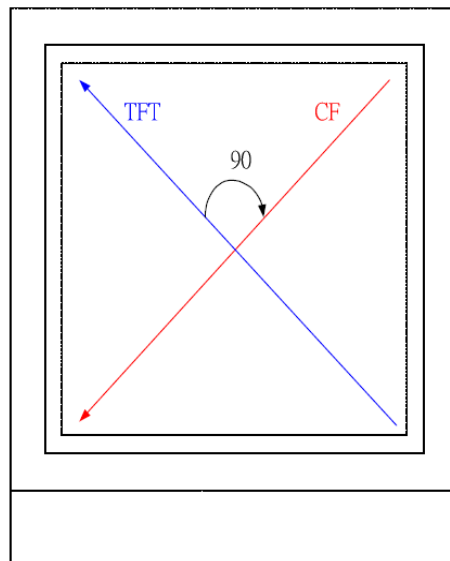

11. Reliability Test Conditions and Methods

NO.	TEST ITEMS	TEST CONDITION	INSPECTION AFTER TEST
<input type="checkbox"/>	High Temperature Storage	80°C±2°C×200Hours	Inspection after 2~4hours storage at room temperature, the samples should be free from defects: 1, Air bubble in the LCD. 2, Seal leak. 3, Non-display. 4, Missing segments. 5, Glass crack. 6, Current IDD is twice higher than initial value. 7, The surface shall be free from damage. 8, The electric characteristic requirements shall be satisfied.
<input type="checkbox"/>	Low Temperature Storage	-30°C±2°C×200Hours	
<input type="checkbox"/>	High Temperature Operating	70°C±2°C×120Hours	
<input type="checkbox"/>	Low Temperature Operating	-20°C±2°C×120Hours	
<input type="checkbox"/>	Temperature Cycle(Storage)	$ \begin{array}{ccccc} -20^{\circ}\text{C} & \longleftrightarrow & 25^{\circ}\text{C} & \longleftrightarrow & 70^{\circ}\text{C} \\ (30\text{min}) & & (5\text{min}) & & (30\text{min}) \\ & & \longleftarrow & & \longrightarrow \\ & & \text{1cycle} & & \\ & & \text{Total 10cycle} & & \end{array} $	
<input type="checkbox"/>	Damp Proof Test (Storage)	50°C±5°C×90%RH×120Hours	
<input type="checkbox"/>	Vibration Test	Frequency:10Hz~55Hz~10Hz Amplitude:1.5M X,Y,Z direction for total 3hours (Packing Condition)	
<input type="checkbox"/>	Drooping Test	Drop to the ground from 1M height one time every side of carton. (Packing Condition)	
<input type="checkbox"/>	ESD Test	Voltage:±8KV,R:330Ω,C:150PF,Air Mode,10times	

REMARK:

- 1, The Test samples should be applied to only one test item.
- 2, Sample side for each test item is 5~10pcs.
- 3, For Damp Proof Test, Pure water(Resistance > 10MΩ) should be used.
- 4, In case of malfunction defect caused by ESD damage, if it would be recovered to normal state after resetting, it would be judge as a good part.
- 5, EL evaluation should be accepted from reliability test with humidity and temperature: Some defects such as black spot/blemish can happen by natural chemical reaction with humidity and Fluorescence EL has.
- 6, Failure Judgment Criterion: Basic Specification Electrical Characteristic, Mechanical Characteristic, Optical Characteristic.

12. Inspection Standard

This standard apply to C-STN/TFT module

1. Spot check plan:

According to spot check level II ,MIL-STD-105D Level II ,the rank of accept or reject is below:

3A、 2A : major non-conformance : AQL 0.25 minor non-conformance : AQL 0.4

1A : major non-conformance : AQL 0.65 minor non-conformance : AQL 1.

2. Inspection condition:

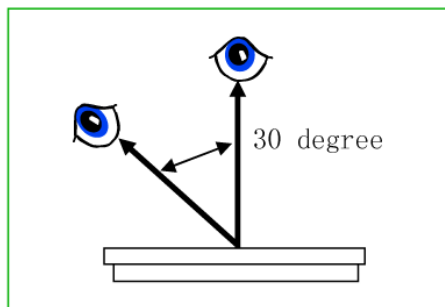

Under daylight lamp 20~40W, product distance inspector 'eye 30cm,incline degree 30°.

3. LCD area define:

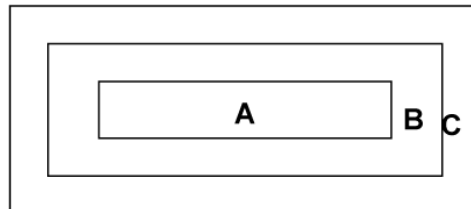

Area A: display area

Area B: VA area

Area C: out of VA area, not in sight after assembly

Remark: non-conformance at area C, but is OK that isn't influence reliability of product & assembly by customer.

4. Inspection standard

4.1 Major non-conformance

NO.	Item	Inspection standard	Rate
4.1.1	Function non-conformance	1) No display, display abnormally 2) Miss line, short 3) B/L no function or function abnormally 4) TP no function	major
4.1.2	miss	No matter miss what component	
4.1.3	Out of size	Module dimension out of spec	

4.2 Appearance non-conformance

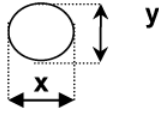
NO.	Item	Inspection standard	Rate																														
4.2.1	Black or white spot (power on)	dot non-conformance define Φ  $\Phi = \frac{x+y}{2}$	Minor																														
		A grade <table border="1"> <thead> <tr> <th rowspan="2">area size (mm)</th> <th colspan="3">Most approve q'ty</th> </tr> <tr> <th>A</th> <th>B</th> <th>C</th> </tr> </thead> <tbody> <tr> <td>$\Phi \leq 0.10$</td> <td colspan="3">ignore</td> </tr> <tr> <td>$0.10 < \Phi \leq 0.15$</td> <td>4</td> <td colspan="2" rowspan="3">ignore</td> </tr> <tr> <td>$0.15 < \Phi \leq 0.20$</td> <td>2</td> </tr> <tr> <td>$0.20 < \Phi \leq 0.25$</td> <td>1</td> </tr> <tr> <td>$0.25 < \Phi$</td> <td>0</td> <td colspan="2"></td> </tr> </tbody> </table> <p>Most approve 4 damages, dot to dot $\geq 10\text{mm}$</p>		area size (mm)	Most approve q'ty			A	B	C	$\Phi \leq 0.10$	ignore			$0.10 < \Phi \leq 0.15$	4	ignore		$0.15 < \Phi \leq 0.20$	2	$0.20 < \Phi \leq 0.25$	1	$0.25 < \Phi$	0									
area size (mm)	Most approve q'ty																																
	A	B	C																														
$\Phi \leq 0.10$	ignore																																
$0.10 < \Phi \leq 0.15$	4	ignore																															
$0.15 < \Phi \leq 0.20$	2																																
$0.20 < \Phi \leq 0.25$	1																																
$0.25 < \Phi$	0																																
4.2.2	Black or white line (power on)	A grade <table border="1"> <thead> <tr> <th colspan="2">Size(mm)</th> <th colspan="3">Most approve q'ty</th> </tr> <tr> <th>L(length)</th> <th>W(width)</th> <th>A</th> <th>B</th> <th>C</th> </tr> </thead> <tbody> <tr> <td>ignore</td> <td>$W \leq 0.03$</td> <td colspan="3">ignore</td> </tr> <tr> <td>$L \leq 5.0$</td> <td>$0.03 < W \leq 0.05$</td> <td colspan="3">3</td> </tr> <tr> <td>$L \leq 3.0$</td> <td>$0.05 < W \leq 0.07$</td> <td colspan="3">2</td> </tr> <tr> <td></td> <td>$0.07 < W$</td> <td colspan="3">Treat with dot non-conformance</td> </tr> </tbody> </table> <p>Most approve 3 damages, line to line $\geq 10\text{mm}$</p>	Size(mm)		Most approve q'ty			L(length)	W(width)	A	B	C	ignore	$W \leq 0.03$	ignore			$L \leq 5.0$	$0.03 < W \leq 0.05$	3			$L \leq 3.0$	$0.05 < W \leq 0.07$	2				$0.07 < W$	Treat with dot non-conformance			Minor
Size(mm)		Most approve q'ty																															
L(length)	W(width)	A	B	C																													
ignore	$W \leq 0.03$	ignore																															
$L \leq 5.0$	$0.03 < W \leq 0.05$	3																															
$L \leq 3.0$	$0.05 < W \leq 0.07$	2																															
	$0.07 < W$	Treat with dot non-conformance																															

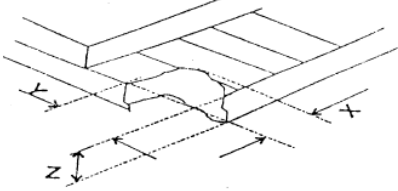
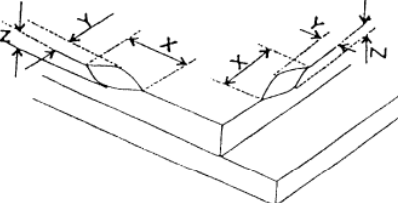
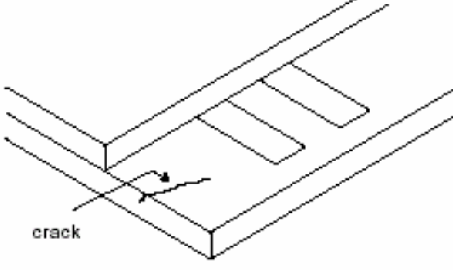
4.2.3	Polarizer position	1) Polarizer attach meet drawing, disallow out of LCD. 2) Polarizer must cover display area (special require unless)	Minor												
4.2.4	LCD non-conformance	<p>(i) crash at side (remark: S=ITO length)</p>  <table border="1" data-bbox="609 672 1177 788"> <thead> <tr> <th>X</th> <th>Y</th> <th>Z</th> </tr> </thead> <tbody> <tr> <td>≤3.0</td> <td>≤S</td> <td>ignore</td> </tr> </tbody> </table> <p>Crash disallow extend to ITO or seal.</p> <p>(ii) commonly surface scathe</p>  <table border="1" data-bbox="590 1131 1197 1247"> <thead> <tr> <th>X</th> <th>Y</th> <th>Z</th> </tr> </thead> <tbody> <tr> <td>≤2.0</td> <td><frame edge</td> <td>ignore</td> </tr> </tbody> </table> <p>(iii) crack</p> <p>Disallow extend crack</p> 	X	Y	Z	≤3.0	≤S	ignore	X	Y	Z	≤2.0	<frame edge	ignore	Minor
X	Y	Z													
≤3.0	≤S	ignore													
X	Y	Z													
≤2.0	<frame edge	ignore													
4.2.5	Contrast voltage warp	VOP/Vlcd voltage of confirmed sample ±0.15V	Minor												
4.2.6	color	Color & luminance of module scope reference spec	Minor												
4.2.7	Cross talk	Reference confirmed limit sample	Minor												

13. Handling Precautions

13.1 Mounting method

The LCD panel of AMSON TFT module consists of two thin glass plates with polarizers which easily be damaged. And since the module is so constructed as to be fixed by utilizing fitting holes in the printed circuit board.

Extreme care should be needed when handling the LCD modules.

13.2 Caution of LCD handling and cleaning

When cleaning the display surface, Use soft cloth with solvent

[Recommended below] and wipe lightly

- Isopropyl alcohol
- Ethyl alcohol

Do not wipe the display surface with dry or hard materials that will damage the polarizer surface.

Do not use the following solvent:

- Water
- Aromatics

Do not wipe ITO pad area with the dry or hard materials that will damage the ITO patterns

Do not use the following solvent on the pad or prevent it from being contaminated:

- Soldering flux
- Chlorine (Cl) , Sulfur (S)

If goods were sent without being silicon coated on the pad, ITO patterns could be damaged due to the corrosion as time goes on.

If ITO corrosion happens by miss-handling or using some materials such as Chlorine (Cl), Sulfur (S) from customer, Responsibility is on customer.

13.3 Caution against static charge

The LCD module uses C-MOS LSI drivers, so we recommend that you:

Connect any unused input terminal to VDD or GND, do not input any signals before power is turned on, and ground your body, work/assembly areas, and assembly equipment to protect against static electricity.

13.4 packing

- Module employs LCD elements and must be treated as such.
- Avoid intense shock and falls from a height.
- To prevent modules from degradation, do not operate or store them exposed direct to sunshine or high temperature/humidity

13.5 Caution for operation

- It is an indispensable condition to drive LCD's within the specified voltage limit since the higher voltage than the limit causes the shorter LCD life.
- An electrochemical reaction due to direct current causes LCD's undesirable deterioration, so that the use of direct current drive should be avoided.
- Response time will be extremely delayed at lower temperature than the operating temperature range and on the other hand at higher temperature LCD's show dark color in them. However those phenomena do not mean malfunction or out of order with LCD's, which will come back in the specified operation temperature.
- If the display area is pushed hard during operation, some font will be abnormally displayed but it resumes normal condition after turning off once.
- Slight dew depositing on terminals is a cause for electro-chemical reaction resulting in terminal open circuit.

Usage under the maximum operating temperature, 50%Rh or less is required.

13.6 storing

In the case of storing for a long period of time for instance, for years for the purpose or replacement use, the following ways are recommended.

- Storage in a polyethylene bag with the opening sealed so as not to enter fresh air outside in it. And with no desiccant.
- Placing in a dark place where neither exposure to direct sunlight nor light's keeping the storage temperature range.
- Storing with no touch on polarizer surface by the anything else.
[It is recommended to store them as they have been contained in the inner container at the time of delivery from us.]

13.7 Safety

- It is recommendable to crash damaged or unnecessary LCD's into pieces and wash off liquid crystal by either of solvents such as acetone and ethanol, which should be burned up later.
- When any liquid leaked out of a damaged glass cell comes in contact with your hands, please wash it off well with soap and water.

14. Precaution for Use

14.1

A limit sample should be provided by the both parties on an occasion when the both parties agreed its necessity. Judgment by a limit sample shall take effect after the limit sample has been established and confirmed by the both parties.

14.2

On the following occasions, the handing of problem should be decided through discussion and agreement between responsible of the both parties.

- When a question is arisen in this specification.
- When a new problem is arisen this is not specified in this specification.
- When an inspection specifications change or operating condition change in customer is reported to AMSON TFT and some problem is arisen in this specification due to the change.
- When a new problem is arisen at the customer's operating set for sample evaluation in the customer site.

15. Packing Method

