

Specification for Approval

Customer: _____

Model Name: _____

Supplier Approval			Customer approval
R&D Designed	R&D Approved	QC Approved	
<i>Peter</i>	<i>Peng Jun</i>		

Revision Record

REV NO.	REV DATE	CONTENTS	Note
A	2019-11-20	NEW ISSUE	

Table of Contents

List	Description	Page No.
	Cover	1
	Revision Record	2
	Table of Contents	3
1	Scope	4
2	General Information	4
3	External Dimensions	5
4	Interface Description	6
5	Absolute Maximum Ratings	7
6	DC Characteristics	7
7	Timing Characteristics	8
8	Backlight Characteristics	11
9	Optical Characteristics	12
10	Reliability Test Conditions and Methods	14
11	Handling Precautions	15
12	Precaution for Use	16
13	Packing Method	16

1. Scope

This specification defines general provisions as well as inspection standards for TFT module supplied by AMSON electronics.

If the event of unforeseen problem or unspecified items may occur, naturally shall negotiate and agree to solution

2. General Information

ITEM	STANDARD VALUES	UNITS
LCD type	1.9" TFT	--
Dot arrangement	170(RGB)×320	dots
Color filter array	RGB vertical stripe	--
Display mode	IPS / Transmissive / Normally Black	-
Gray Scale Inversion Direction	80/80/80/80	--
Eyes Viewing Direction	ALL	--
Driver IC	ST7789V	--
Module size	25.80(W)×49.72(H)×1.36(T)	mm
Active area	22.70(W)×42.72(H)	mm
Interface	4 line SPI / 8-bit MCU interface	--
Operating temperature	-20 ~ +70	°C
Storage temperature	-30 ~ +80	°C
Back Light	4 White LED	--

3. External Dimensions

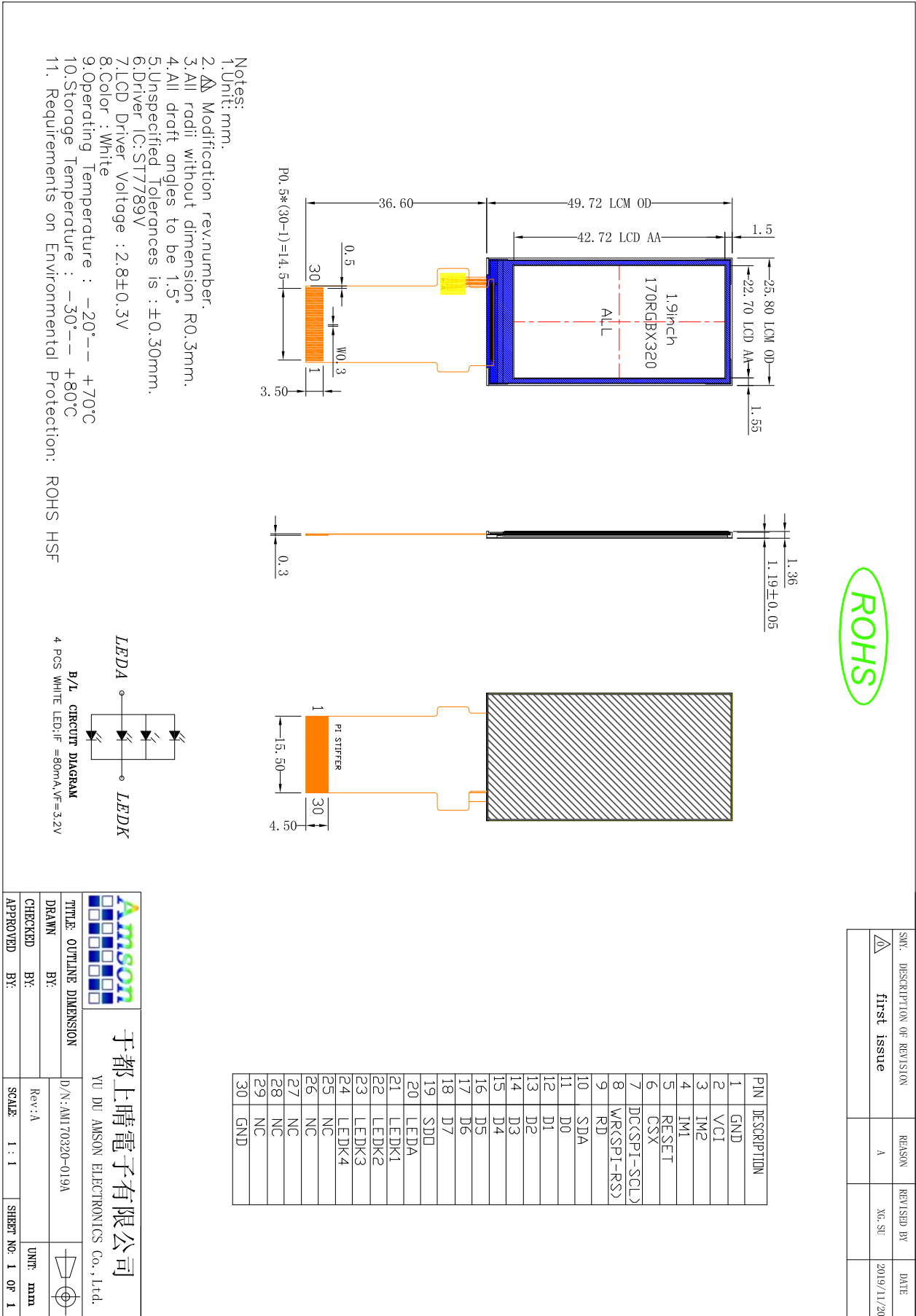

4. Interface Description

PIN NO.	PIN NAME	DESCRIPTION
1	GND	Ground
2	VCI	Power Supply 2.8V Voltage
3	IM2	when IM1=0, IM2=0, 8080-8bit; when IM1=1, IM2=1, 4-line SPI serial
4	IM1	
5	RESET	LCM Reset input signal
6	CSX	Input pin for chip selection signal
7	DC(SPI-SCL)	When connecting to an 8080-series microprocessor, this pin receives the data/command selection pin .This pin is used to be serial interface clock in 4-line serial interface
8	WR(SPI-RS)	When connecting to an 8080-series microprocessor, this pin receives the write signal. Display data/command selection pin in 4-line serial interface.
9	RD	When connecting to an 8080-series microprocessor, this pin receives the Read signal. Read operation is initiated when this pin is pulled LOW and the chip is selected. When serial interface is selected, this pin must be connected to Ground.
10	SDA	SPI interface input/output pin. The data is latched on the rising edge of the SCL signal.
11-18	D0-D7	MCU parallel interface data bus.
19	SDO	SPI interface output pin.
20	LEDA	LED Anode
21	LEDK	LED Cathode
22	LEDK	LED Cathode
23	LEDK	LED Cathode
24	LEDK	LED Cathode
25-29	NC	No Connect
30	GND	Ground

5. Absolute Maximum Ratings

Item	Symbol	Min.	Max.	Unit
Power Supply Voltage	V _{CI}	-0.3	4.6	V
Operating Temperature	T _{OP}	-20	70	°C
Storage Temperature	T _{ST}	-30	80	°C
Storage Humidity	HD	20	90	%RH

6. DC Characteristics

Item	Symbol	Min.	Typ.	Max.	Unit	Remark
Power Supply Voltage	V _{CI}	2.6	2.8	3.3	V	-
Supply Current	I _{CC}	-	-	25	mA	V _{CI} =2.8V.T _a =25°C
Input High Voltage	V _{IH}	0.8IOVCC	-	IOVCC	V	-
Input Low Voltage	V _{IL}	GND	-	0.2IOVCC	V	-
Output High Voltage	V _{OH}	0.8IOVCC	-	IOVCC	V	-
Output Low Voltage	V _{OL}	GND	-	0.2IOVCC	V	-
I/O Leak Current	I _{LI}	-1.0	-	1.0	uA	-

Note: Voltage greater than above may damage the module.
 All voltages are specified relative to VSS=0V.

7. Timing Characteristics

7.1 Serial Interface Characteristics (4-line serial):

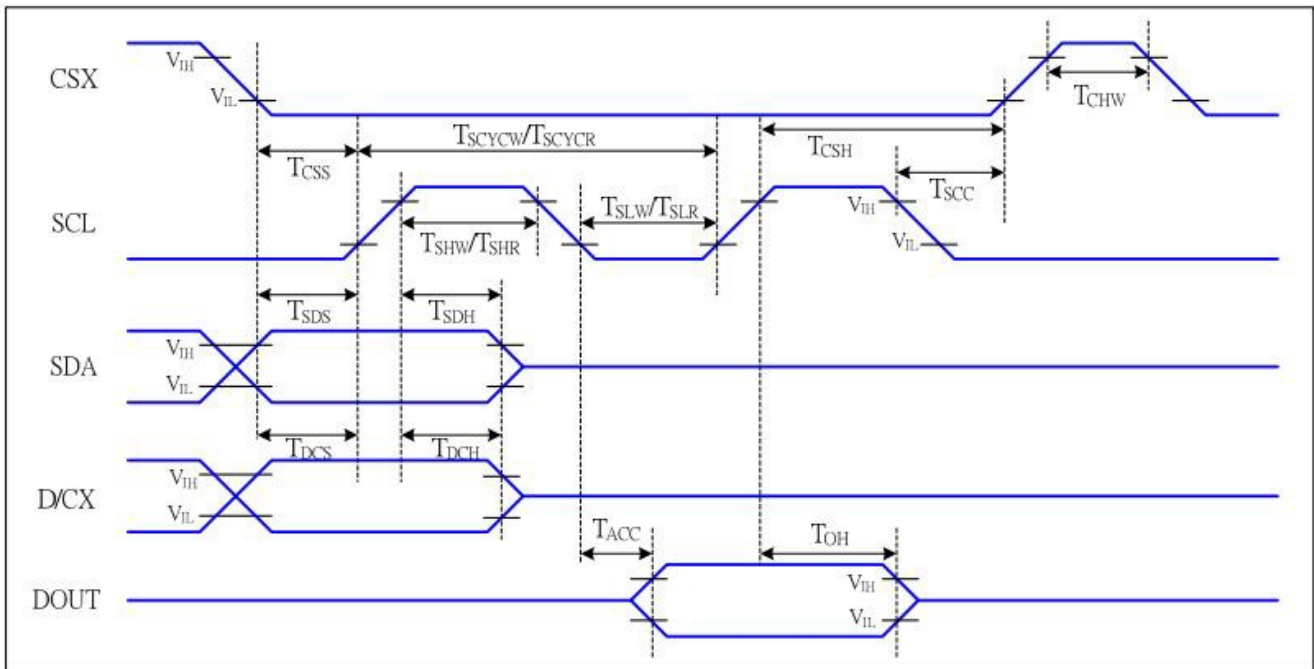

Signal	Symbol	Parameter	MIN	MAX	Unit	Description
CSX	T _{css}	Chip select setup time (write)	15		ns	
	T _{sch}	Chip select hold time (write)	15		ns	
	T _{css}	Chip select setup time (read)	60		ns	
	T _{scc}	Chip select hold time (read)	65		ns	
	T _{ch}	Chip select "H" pulse width	40		ns	
SCL	T _{scy} _W	Serial clock cycle (Write)	66		ns	-write command & data ram
	T _{shw}	SCL "H" pulse width (Write)	15		ns	
	T _{slw}	SCL "L" pulse width (Write)	15		ns	
	T _{scy} _R	Serial clock cycle (Read)	150		ns	-read command & data ram
	T _{shr}	SCL "H" pulse width (Read)	60		ns	
	T _{slr}	SCL "L" pulse width (Read)	60		ns	
D/CX	T _{dcs}	D/CX setup time	10		ns	
	T _{dch}	D/CX hold time	10		ns	
SDA (DIN)	T _{sdh}	Data hold time	10		ns	
	T _{sdh}	Data hold time	10		ns	
DOUT	T _{acc}	Access time	10	50	ns	For maximum CL=30pF
	T _{oh}	Output disable time	15	50	ns	For minimum CL=8pF

7.2 i80-System Interface Timing Characteristics

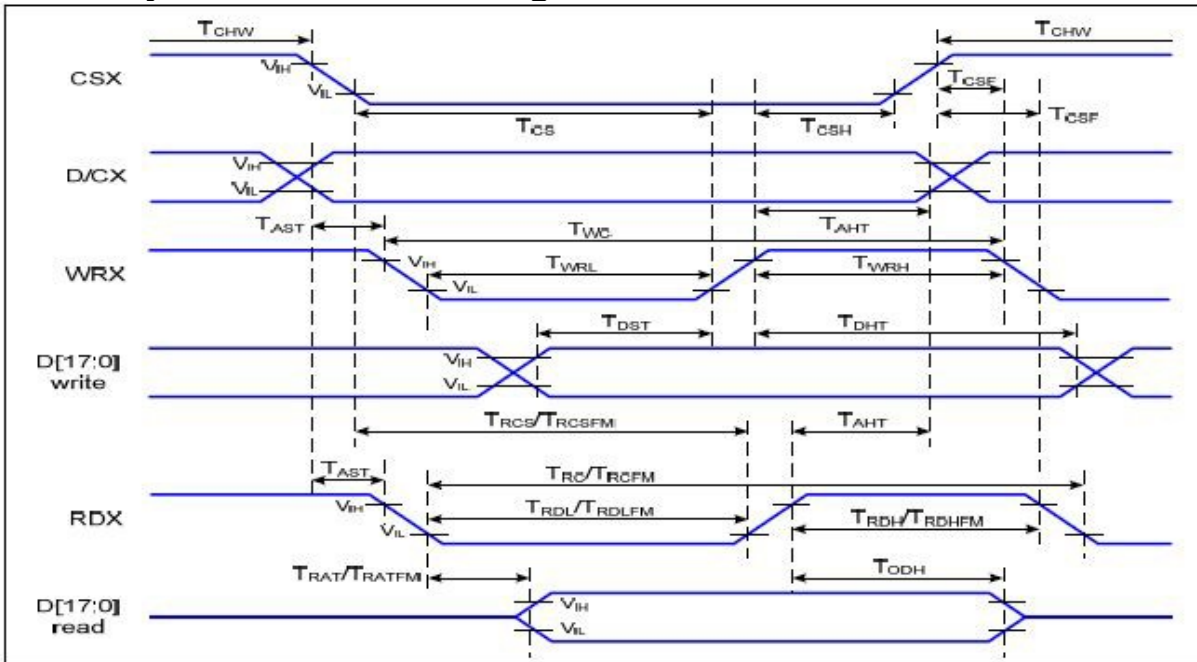
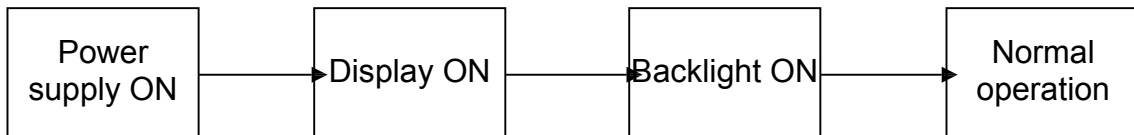
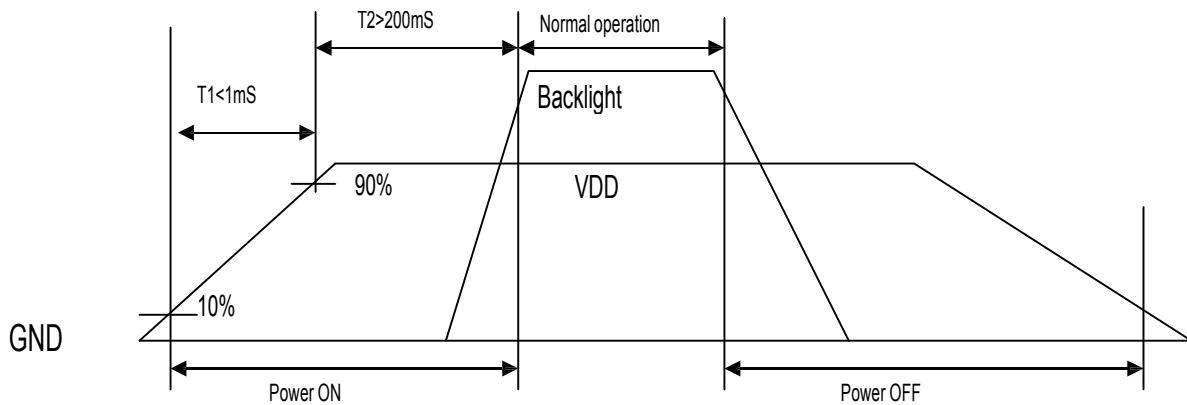

Figure 1 Parallel Interface Timing Characteristics (8080-Series MCU Interface)

VDDI=1.65 to 3.3V, VDD=2.4 to 3.3V, AGND=DGND=0V, Ta= -30 to 70 °C

Signal	Symbol	Parameter	Min	Max	Unit	Description
D/CX	T_{AST}	Address setup time	0		ns	
	T_{AHT}	Address hold time (Write/Read)	10		ns	
CSX	T_{CHW}	Chip select "H" pulse width	0		ns	
	T_{CS}	Chip select setup time (Write)	15		ns	
	T_{RCS}	Chip select setup time (Read ID)	45		ns	
	T_{RCSFM}	Chip select setup time (Read FM)	355		ns	
	T_{CSF}	Chip select wait time (Write/Read)	10		ns	
	T_{CSH}	Chip select hold time	10		ns	
WRX	T_{WC}	Write cycle	66		ns	
	T_{WRH}	Control pulse "H" duration	15		ns	
	T_{WRL}	Control pulse "L" duration	15		ns	
RDX (ID)	T_{RC}	Read cycle (ID)	160		ns	When read ID data
	T_{RDH}	Control pulse "H" duration (ID)	90		ns	
	T_{RDL}	Control pulse "L" duration (ID)	45		ns	
RDX (FM)	T_{RCFM}	Read cycle (FM)	450		ns	When read from frame memory
	T_{RDHF}	Control pulse "H" duration (FM)	90		ns	
	T_{RDLF}	Control pulse "L" duration (FM)	355		ns	
D[17:0]	T_{DST}	Data setup time	10		ns	For CL=30pF

7.3 Power ON/OFF Timing



Power ON sequence

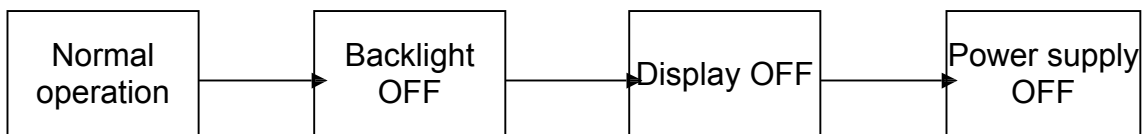

Power OFF sequence

8. Backlight Characteristic

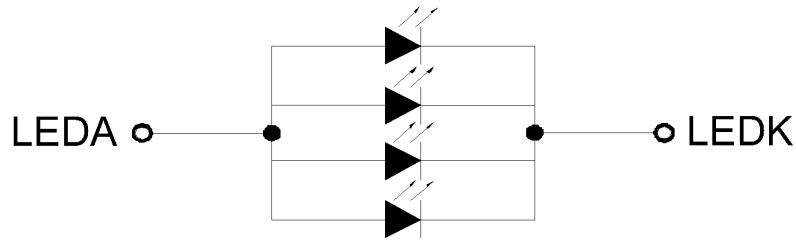

BL CIRCUIT DIAGRAM:

Item	Symbol	MIN	TYP	MAX	UNIT	Test Condition
Supply Voltage	Vf	-	3.2	-	V	If=80mA
Supply Current	If	-	80	-	mA	-
Luminous Intensity for LCM	-	300	350	-	cd/m ²	If=80mA
Uniformity for LCM	-	70	80	-	%	If=80mA
Life Time	-	20000	-	-	Hr	If=80mA
Backlight Color	White					

9. Optical Characteristics

Item	Conditions	Min.	Typ.	Max.	Unit	Note	
Viewing Angle (CR>10)	Horizontal	θ_L	80	-	-	degree	(1),(2),(6)
		θ_R	80	-	-		
	Vertical	θ_T	80	-	-		
		θ_B	80	-	-		
Contrast Ratio	Center	700	900	-	-	(1),(3),(6)	
Response Time	Rising	-	30	35	ms	(1),(4),(6)	
	Falling						
CF Color Chromaticity (CIE1931)	Red x	Typ. -0.05	TBD	Typ. +0.05	-	(1), (6)	
	Red y		TBD		-		
	Green x		TBD		-		
	Green y		TBD		-		
	Blue x		TBD		-		
	Blue y		TBD		-		
	White x		TBD		-		
	White y		TBD		-		
Transmittance	-	-	5.5	-	%	(1),(5),(6)	

Note (1) Measurement Setup: The LCD module should be stabilized at given temp. 25°C for 15 minutes to avoid abrupt temperature change during measuring. In order to stabilize the luminance, the measurement should be executed after lighting backlight for 15 minutes in a windless room.

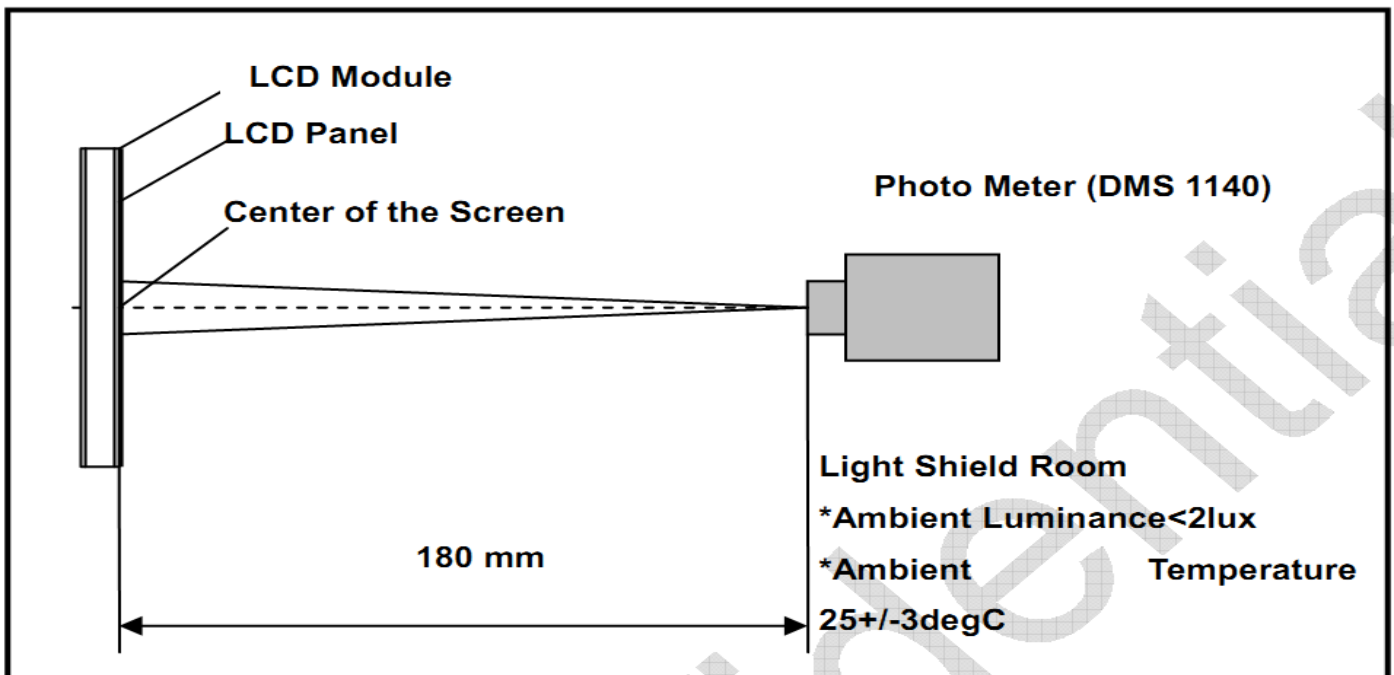

Note (2) Definition of Viewing Angle

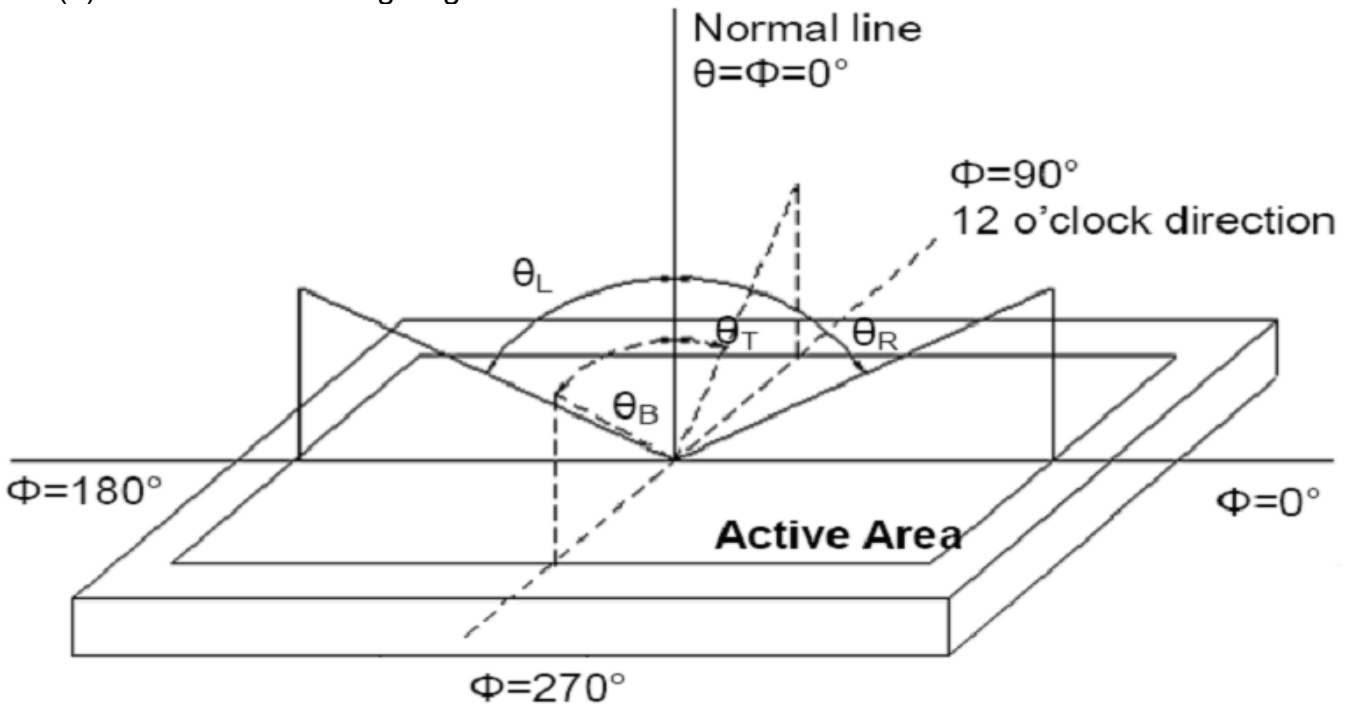

Note (3) Definition of Contrast Ratio (CR)

The contrast ratio can be calculated by the following expression

$$\text{Contrast Ratio (CR)} = L_{63} / L_0$$

L63: Luminance of gray level 63, L0: Luminance of gray level 0

Note (4) Definition of response time

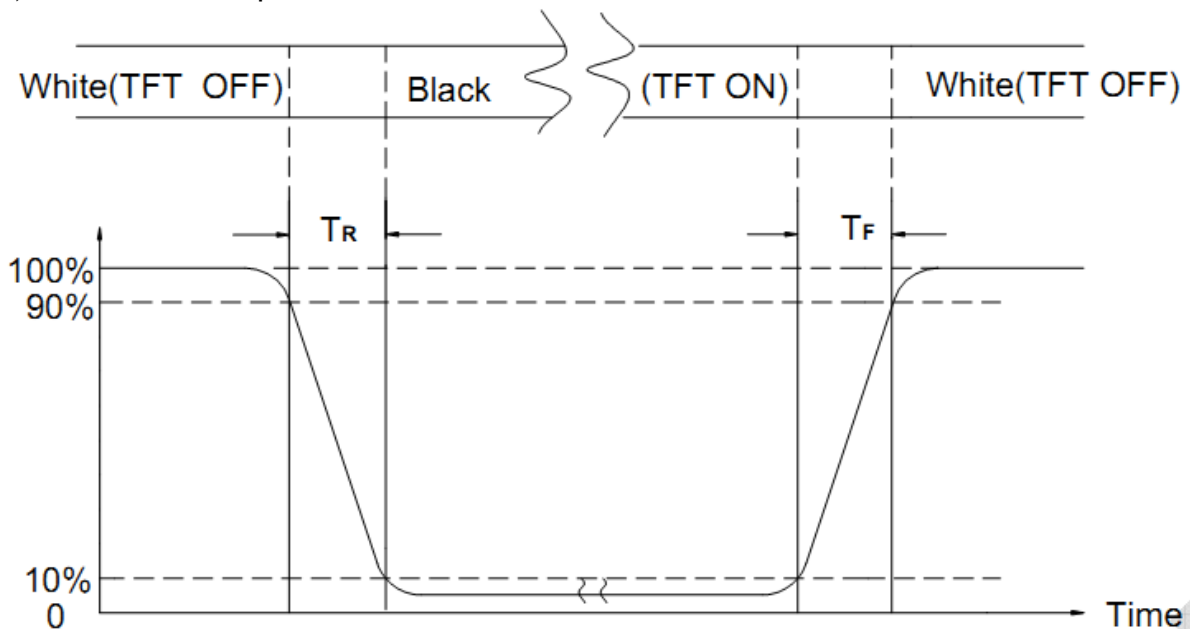

Note (5) Definition of Transmittance (Module is without signal input)

$$\text{Transmittance} = \text{Center Luminance of LCD} / \text{Center Luminance of Back Light} \times 100\%$$

Note (6) Definition of color chromaticity (CIE1931)

Color coordinates measured at the center point of LCD

10. Reliability Test Conditions And Methods

Item	Condition	Time (hrs)	Assessment
High temp. Storage	80°C	120	No abnormalities in functions and appearance
High temp. Operating	70°C	120	
Low temp. Storage	-30°C	120	
Low temp. Operating	-20°C	120	
Humidity	40°C/ 90%RH	120	
Thermal Shock(Non-operation)	-20°C → 25°C →70°C (0.5 hour → 5 min → 0.5 hour)	10cycles	

11. Handling Precautions

11.1 Mounting method

The LCD panel of AMSON TFT module consists of two thin glass plates with polarizers which easily be damaged. And since the module is so constructed as to be fixed by utilizing fitting holes in the printed circuit board.

Extreme care should be needed when handling the LCD modules.

11.2 Caution of LCD handling and cleaning

When cleaning the display surface, Use soft cloth with solvent

[Recommended below] and wipe lightly

- Isopropyl alcohol
- Ethyl alcohol

Do not wipe the display surface with dry or hard materials that will damage the polarizer surface.

Do not use the following solvent:

- Water
- Aromatics

Do not wipe ITO pad area with the dry or hard materials that will damage the ITO patterns

Do not use the following solvent on the pad or prevent it from being contaminated:

- Soldering flux
- Chlorine (Cl) , Sulfur (S)

If goods were sent without being silicon coated on the pad, ITO patterns could be damaged due to the corrosion as time goes on.

If ITO corrosion happens by miss-handling or using some materials such as Chlorine (Cl), Sulfur (S) from customer, Responsibility is on customer.

11.3 Caution against static charge

The LCD module uses C-MOS LSI drivers, so we recommend that you:

Connect any unused input terminal to POWER or GROUND, do not input any signals before power is turned on, and ground your body, work/assembly areas, and assembly equipment to protect against static electricity.

12.4 packing

- Module employs LCD elements and must be treated as such.
- Avoid intense shock and falls from a height.
- To prevent modules from degradation, do not operate or store them exposed direct to sunshine or high temperature/humidity

11.5 Caution for operation

- It is an indispensable condition to drive LCD's within the specified voltage limit since the higher voltage than the limit causes the shorter LCD life.
- An electrochemical reaction due to direct current causes LCD's undesirable deterioration, so that the use of direct current drive should be avoided.
- Response time will be extremely delayed at lower temperature than the operating temperature range and on the other hand at higher temperature LCD's show dark color in them. However those phenomena do not mean malfunction or out of order with LCD's, which will come back in the specified operation temperature.
- If the display area is pushed hard during operation, some font will be abnormally displayed but it resumes normal condition after turning off once.
- Slight dew depositing on terminals is a cause for electro-chemical reaction resulting in terminal open circuit.

Usage under the maximum operating temperature, 50%Rh or less is required.

11.6 storing

In the case of storing for a long period of time for instance, for years for the purpose or replacement use, the following ways are recommended.

- Storage in a polyethylene bag with the opening sealed so as not to enter fresh air outside in it . And with no desiccant.
- Placing in a dark place where neither exposure to direct sunlight nor light's keeping the storage temperature range.
- Storing with no touch on polarizer surface by the anything else.
[It is recommended to store them as they have been contained in the inner container at the time of delivery from us

11.7 Safety

- It is recommendable to crash damaged or unnecessary LCD's into pieces and wash off liquid crystal by either of solvents such as acetone and ethanol, which should be burned up later.
- When any liquid leaked out of a damaged glass cell comes in contact with your hands, please wash it off well with soap and water

12. Precaution for Use

12.1

A limit sample should be provided by the both parties on an occasion when the both parties agreed its necessity. Judgment by a limit sample shall take effect after the limit sample has been established and confirmed by the both parties.

12.2

On the following occasions, the handing of problem should be decided through discussion and agreement between responsible of the both parties.

- When a question is arisen in this specification.
- When a new problem is arisen which is not specified in this specifications?
- When an inspection specifications change or operating condition change in customer is reported to AMSON TFT and some problem is arisen in this specification due to the change.
- When a new problem is arisen at the customer's operating set for sample evaluation in the customer site.

13. Packing Method

TBD