



# Specification for Approval

Customer: \_\_\_\_\_

Model Name: \_\_\_\_\_

Supplier Approval			Customer approval
R&D Designed	R&D Approved	QC Approved	
<i>Peter</i>	<i>Peng Jun</i>		

## Revision Record

REV NO.	REV DATE	CONTENTS	Note
A	2012-07-10	NEW ISSUE	

## Table of Contents

List	Description	Page No.
	Cover	1
	Revision Record	2
	Table of Contents	3
1	Scope	4
2	General Information	4
3	External Dimensions	5
4	Interface Description	6
5	Absolute Maximum Ratings	8
6	Electrical Characteristics	8
7	Timing Characteristics	9
8	Backlight Characteristics	14
9	Optical Characteristics	15
10	Reliability Test Conditions and Methods	17
11	Inspection Standard	18
12	Handling Precautions	21
13	Precaution for Use	22
14	Packing Method	23

## 1. Scope

This specification defines general provisions as well as inspection standards for TFT module supplied by AMSON electronics.

If the event of unforeseen problem or unspecified items may occur, naturally shall negotiate and agree to solution.

## 2. General Information

ITEM	STANDARD VALUES	UNITS
LCD type	3.5" TFT	--
Dot arrangement	320(RGB) × 240	dots
Color filter array	RGB vertical stripe	--
Display mode	TN / Transmissive / Normally White	--
Viewing Direction	6 o'clock (Gray scale inversion)	--
Driver IC	HX8238-D	--
Module size	76.9(W) × 63.9(H) × 3.26(T)	mm
Active area	70.08(W) × 52.56(H)	mm
Dot pitch	0.219(W) × 0.219(H)	mm
Interface	24 bits RGB with Serial Interface / CCIR656	--
Operating temperature	-20 ~ +70	°C
Storage temperature	-30 ~ +80	°C
Back Light	6 White LED	--
Weight	TBD	g



## 4. Interface Description

PIN NO.	PIN NAME	DESCRIPTION
1	LEDK	LED backlight cathode
2	LEDK	LED backlight cathode
3	LEDA	LED backlight anode
4	LEDA	LED backlight anode
5	NC	No Connection
6	NC	No Connection
7	NC	No Connection
8	/RESET	System Reset
9	SPENA	SPI ENABLE
10	SPCLK	SERIAL CLOCK SIGNAL
11	SPDAT	SERIAL DATA SIGNAL
12	DB0	RGB Data Bus
13	DB1	
14	DB2	
15	DB3	
16	DB4	
17	DB5	
18	DB6	
19	DB7	
20	DG0	
21	DG1	
22	DG2	
23	DG3	
24	DG4	
25	DG5	
26	DG6	
27	DG7	
28	DR0	
29	DR1	
30	DR2	
31	DR3	
32	DR4	
33	DR5	
34	DR6	
35	DR7	
36	HSYNC	Line synchronizing signal for RGB interface operation
37	VSYNC	Frame synchronizing signal for RGB interface operation
38	DOTCLK	Dot Clock
39	NC	No Connection

40	NC	No Connection
41	VCC	Power supply
42	VCC	Power supply
43	NC	No Connection
44	NC	No Connection
45	NC	No Connection
46	NC	No Connection
47	NC	No Connection
48	SEL2	Input Interface Mode
49	SEL1	Input Interface Mode
50	SEL0	Input Interface Mode
51	NC	No Connection.
52	DEN	Display enable pin from controller
53	GND	Power ground
54	GND	Power ground

Note:

SEL2	SEL1	SEL0	Format	Operating Frequency
0	0	0	Parallel-RGB data format (only support stripe type color filter)	6.5MHz
0	0	1	Serial-RGB data format	19.5MHz
0	1	0	CCIR 656 data format (640RGB)	24.54MHz
0	1	1	CCIR 656 data format (720RGB)	27MHz
1	0	0	YUV mode A data format (Cr-Y-Cb-Y)	24.54MHz
1	0	1	YUV mode A data format (Cr-Y-Cb-Y)	27MHz
1	1	0	YUV mode B data format (Cb-Y-Cr-Y)	27MHz
1	1	1	YUV mode B data format (Cb-Y-Cr-Y)	24.54MHz

Input format	DOTCLK Freq (MHz)	Display Data	Active Area (DOTCLK)
YUV mode	24.54	640	1280
	27	720	1440

## 5. Absolute Maximum Ratings

Item	Symbol	Min.	Max.	Unit
Supply Voltage	VCC	-0.3	4.0	V
Input Voltage	V <sub>in</sub>	GND-0.3	4.0	V
Operating Temperature	T <sub>OP</sub>	-20	70	°C
Storage Temperature	T <sub>ST</sub>	-30	80	°C
Storage Humidity	HD	--	90	%RH

## 6. DC Characteristics

Item	Symbol	Min.	Typ.	Max.	Unit	Remark
Supply Voltage	VCC	2.5	--	3.6	V	--
Input High Voltage	V <sub>IH</sub>	0.8 VCC	--	VCC	V	Digital input pins
Input Low Voltage	V <sub>IL</sub>	0	--	0.2 VCC	V	Digital input pins
Output High Voltage	V <sub>OH</sub>	0.9 VCC	--	VCC	V	Digital output pins
Output Low Voltage	V <sub>OL</sub>	0	--	0.1 VCC	V	Digital output pins
Logic Input Current	I <sub>IL</sub> /I <sub>IH</sub>	-1	--	1	uA	--



## 7. Timing Characteristics

### 7.1 Pixel Timing Characteristics

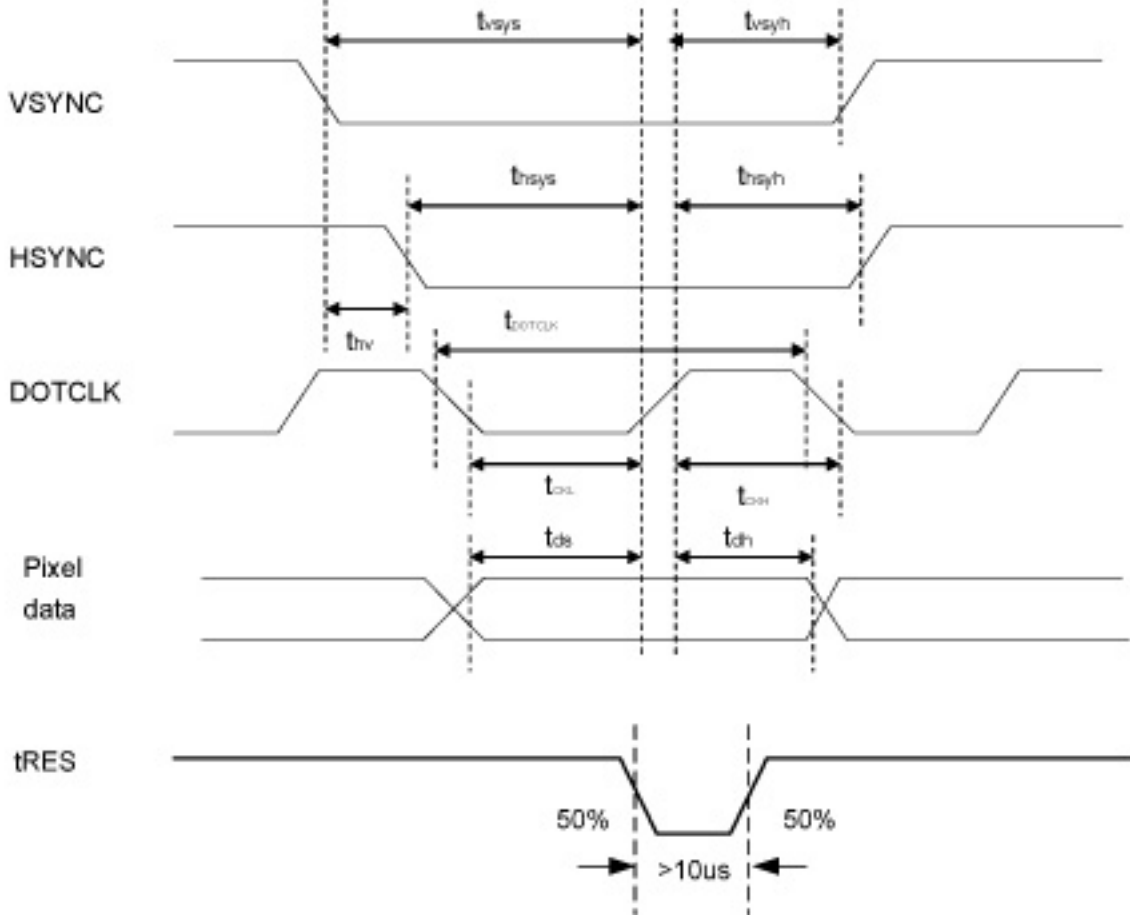

Figure 7. 1 Pixel Timing

Characteristics	Symbol	Min.		Typ.		Max.		Unit
		24 bit	8 bit	24 bit	8 bit	24 bit	8 bit	
DOTCLK Frequency	fDOTCLK	-	-	6.5	19.5	10	30	MHz
DOTCLK Period	tDOTCLK	100	33.3	154	51.3	-	-	ns
Vertical Sync Setup Time	tvsys	20	10	-	-	-	-	ns
Vertical Sync Hold Time	tvsyh	20	10	-	-	-	-	ns
Horizontal Sync Setup Time	thsys	20	10	-	-	-	-	ns
Horizontal Sync Hold Time	thsyh	20	10	-	-	-	-	ns
Phase difference of Sync Signal Falling Edge	thv	1		-		240		tDOTCLK
DOTCLK Low Period	tCKL	50	15	-	-	-	-	ns
DOTCLK High Period	tCKH	50	15	-	-	-	-	ns
Data Setup Time	tds	12	10	-	-	-	-	ns
Data hold Time	tdh	12	10	-	-	-	-	ns
Reset pulse width	tRES	10		-		-		$\mu s$

Note: External clock source must be provided to DOTCLK pin of HX8238-D. The driver will not operate if absent of the clocking signal.

Table 7. 1 Pixel Timing

## 7.2 RGB Interface Timing Characteristics

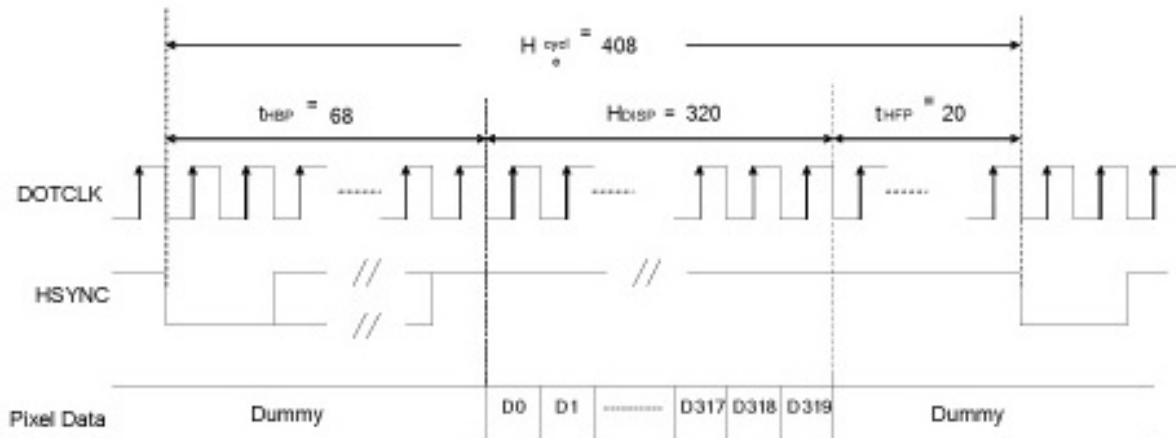

(a) Horizontal Data Transaction Timing

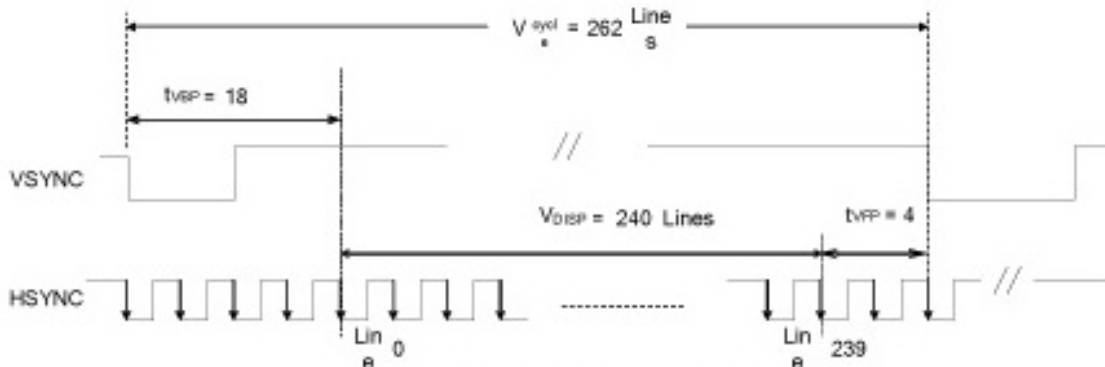

(b) Vertical Data Transaction Timing

**Figure 7. 2 Data Transaction Timing in Parallel RGB (24 bit) Interface (SYNC Mode)**

Characteristics	Symbol	Min.		Typ.		Max.		Unit
		24 bit	8 bit	24 bit	8 bit	24 bit	8 bit	
DOTCLK Frequency	fDOTCLK	-	-	6.5	19.5	10	30	MHz
DOTCLK Period	tDOTCLK	100	33.3	154	51.3	-	-	ns
Horizontal Frequency (Line)	fH	-	-	14.9	-	22.35	-	KHz
Vertical Frequency (Refresh)	fV	-	-	60	-	90	-	Hz
Horizontal Back Porch	tHBP	-	-	68	204	-	-	tDOTCLK
Horizontal Front Porch	tHFP	-	-	20	60	-	-	tDOTCLK
Horizontal Data Start Point	tHBP	-	-	68	204	-	-	tDOTCLK
Horizontal Blanking Period	tHBP + tHFP	-	-	88	264	-	-	tDOTCLK
Horizontal Display Area	HDISP	-	-	320	960	-	-	tDOTCLK
Horizontal Cycle	Hcycle	-	-	408	1224	450	1350	tDOTCLK
Vertical Back Porch	tVBP	-	-	18	-	-	-	Lines
Vertical Front Porch	tVFP	-	-	4	-	-	-	Lines
Vertical Data Start Point	tVBP	-	-	18	-	-	-	Lines
Vertical Blanking Period	tVBP + tVFP	-	-	22	-	-	-	Lines
Vertical Display Area	NTSC	-	-	240		-	-	Lines
	PAL			280(PALM=0)				
	PAL			288(PALM=1)				
Vertical Cycle	NTSC	-	-	262		350	-	Lines
	PAL			313				

**Table 7. 2 Data Transaction Timing in Normal Operating Mode**

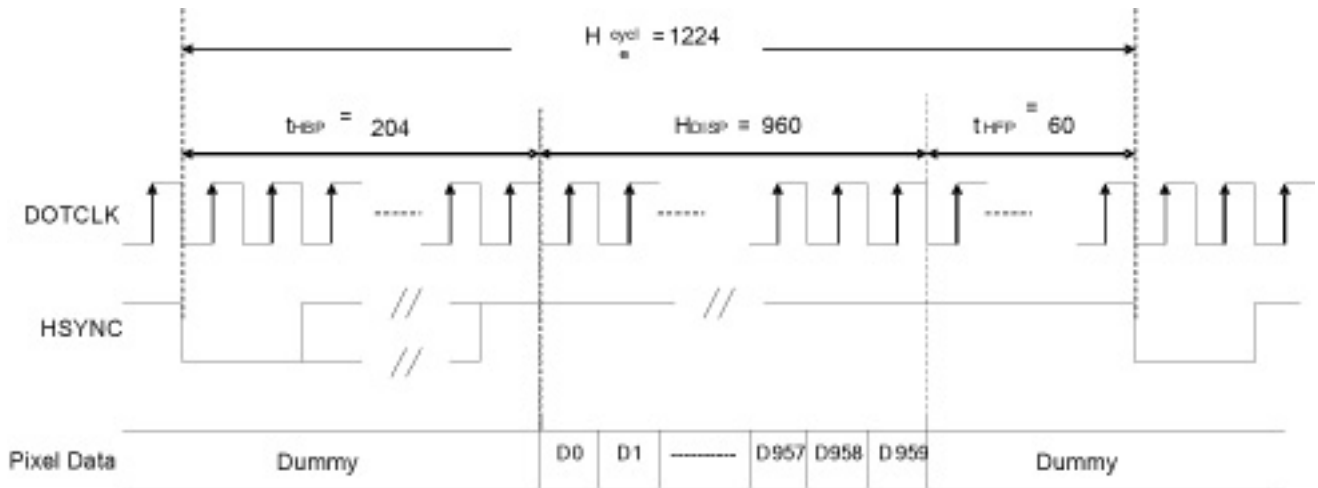

(1) Horizontal Data Transaction Timing

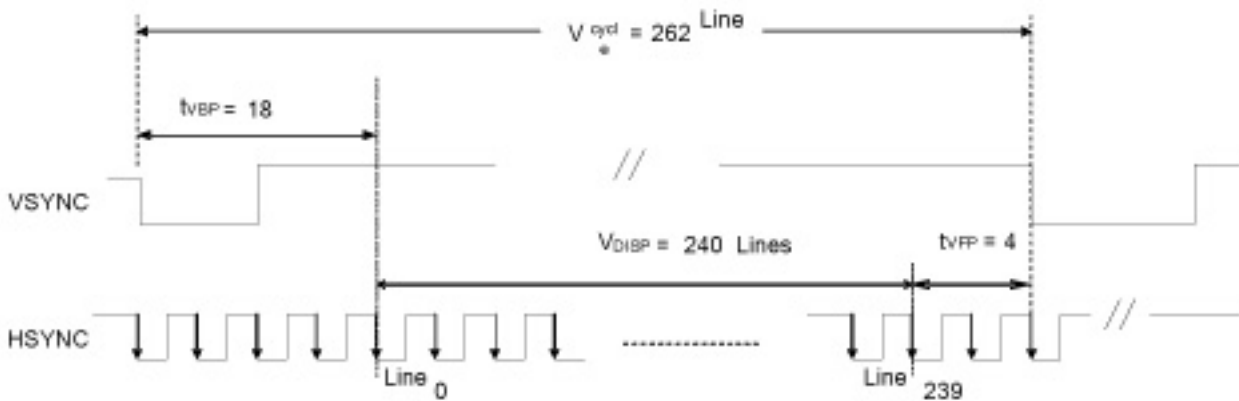

(2) Vertical Data Transaction Timing

**Figure 7. 3 Data Transaction Timing in Serial RGB (8 bit) Interface (SYNC Mode)**

## 7.3 CCIR656 Timing Characteristics

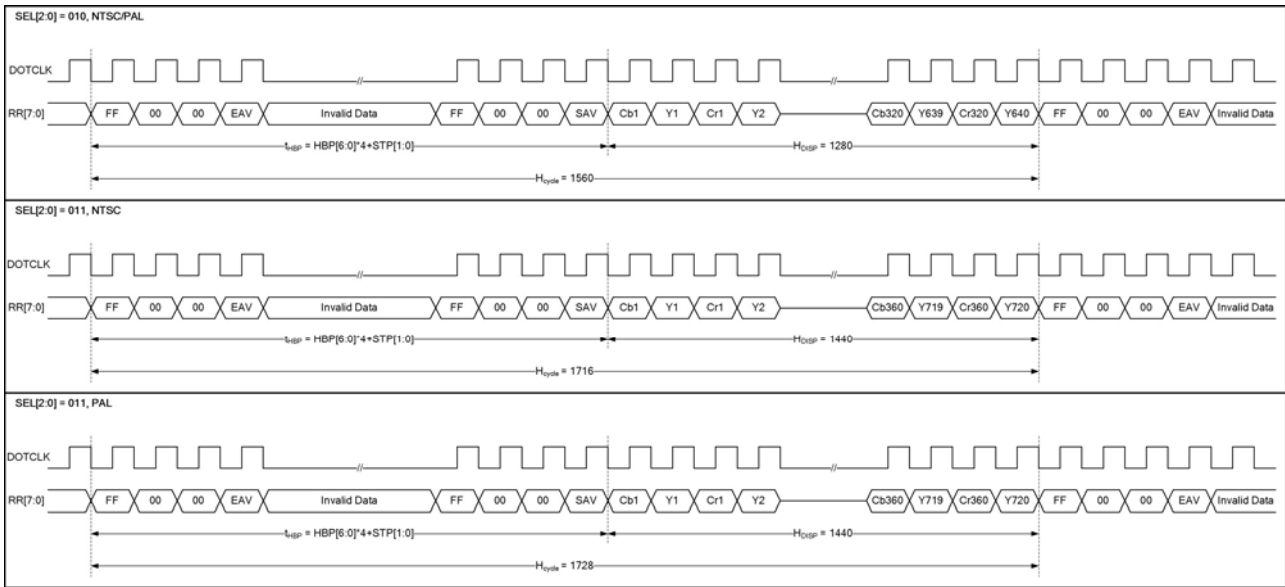

**Figur 7.4 CCIR656 Horizontal Timing**

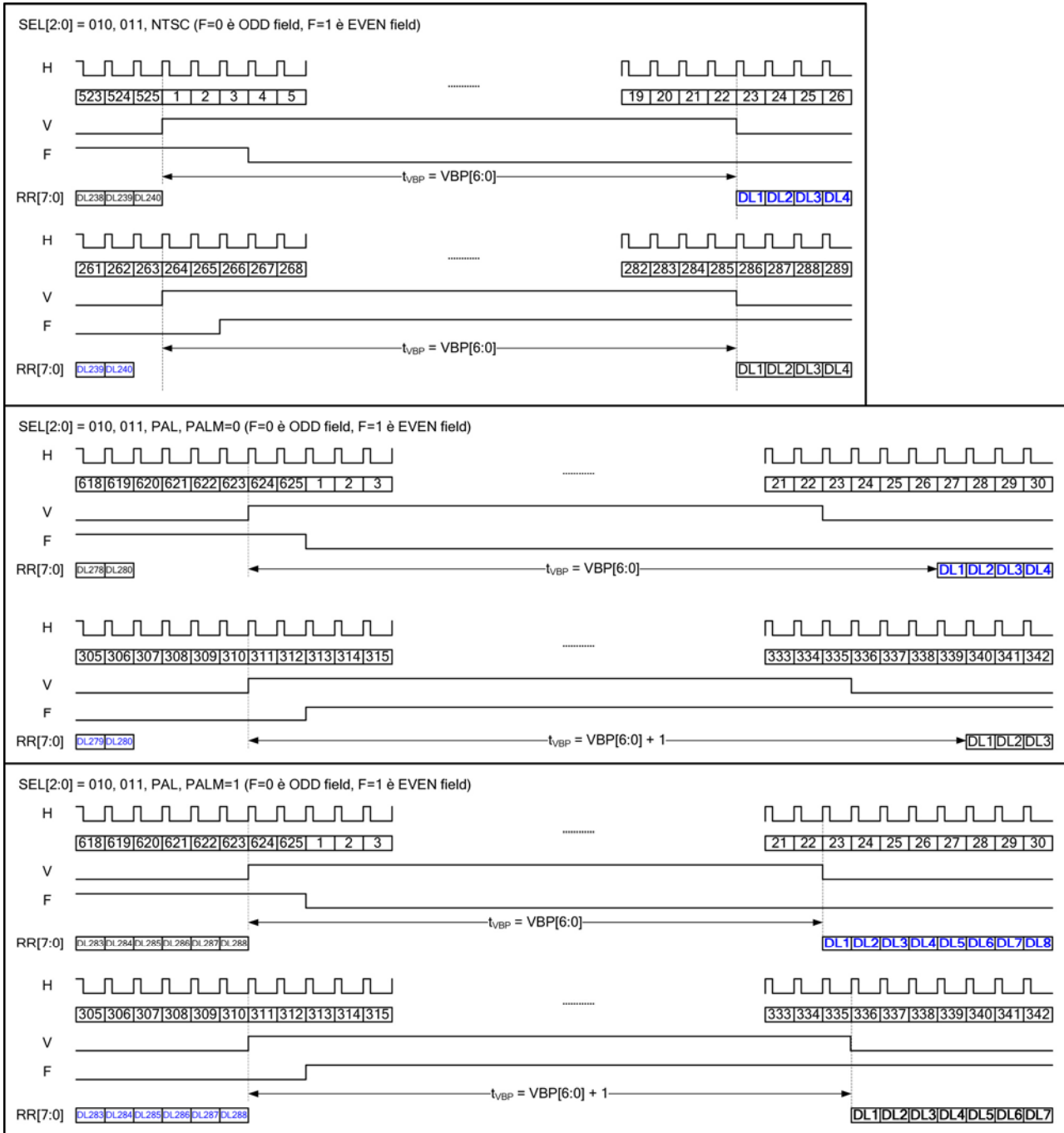
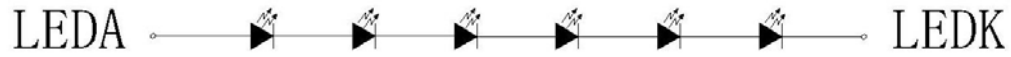

Figure 7.5 CCIR656 Vertical Timing

## 8. Backlight Characteristics

BL Circuit Diagram:



Item	Symbol	MIN	TYP	MAX	UNIT	Test Condition
Supply Voltage	Vf	18	19.2	20	V	If=20mA
Supply Current	If	--	20	--	mA	--
Luminous Intensity for LCM	--	480	550	--	Cd/m <sup>2</sup>	If=20mA
Uniformity for LCM	--	80	--	--	%	If=20mA
Life Time	--	50000	--	--	Hr	If=20mA
Backlight Color	White					

## 9. Optical Characteristics

(Note1 · Note2) (Using Normal Polarizer +CPT Backlight, reference only)

ITEM	SYMBOL	CONDITION	MIN.	TYP.	MAX.	UNIT	REMARK	
Brightness	BL	$\theta = \varphi = 0^\circ$	480	550	--	cd/m <sup>2</sup>	Note2	
Contrast Ratio	CR	$\theta = \varphi = 0^\circ$	150	250	--	--	Note3	
Response Time	Tr+ Tf	$\theta = \varphi = 0^\circ$	--	50	70	ms	Note4	
Viewing Angle	Upper	$\theta$	CR $\geq$ 10	--	45	--	--	Note 5
	Down			--	45	--	--	
	Right	$\varphi$		--	35	--	--	
	Left			--	15	--	--	
Color Filter Chromaticity	White	X y	$\theta = \varphi = 0^\circ$	0.264	0.294	0.324	--	Note 6
				0.304	0.334	0.364	--	
	Red	X y	$\theta = \varphi = 0^\circ$	0.603	0.633	0.663	--	
				0.296	0.326	0.356	--	
	Green	X y	$\theta = \varphi = 0^\circ$	0.267	0.297	0.327	--	
				0.547	0.577	0.607	--	
	Blue	X y	$\theta = \varphi = 0^\circ$	0.103	0.133	0.163	--	
				0.099	0.129	0.159	--	

Note1: Definition of Operation Voltage (Vop)

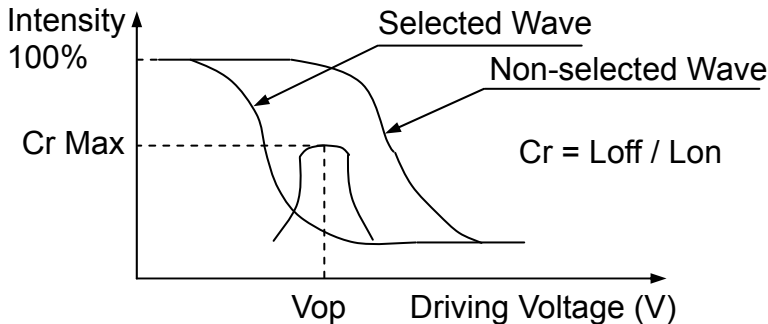

Note2: Definition of Luminance Uniformity :  $L = L(\text{MIN}) / L(\text{MAX}) \times 100\%$

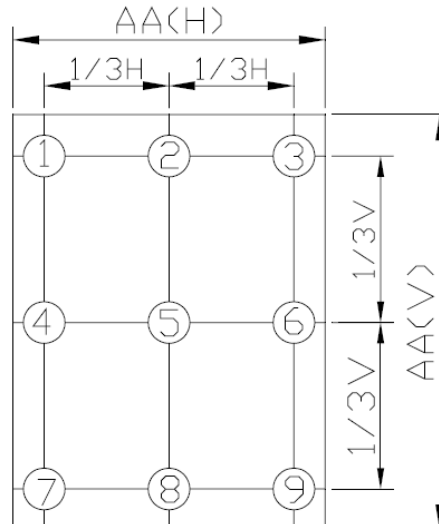

Note 3. Definition of Contrast Ratio:

$$CR = \text{White Luminance (ON)} / \text{Black Luminance (OFF)}$$

Note 4. Definition of response time : The response time is defined as the time interval between the 10% and 90% amplitudes.

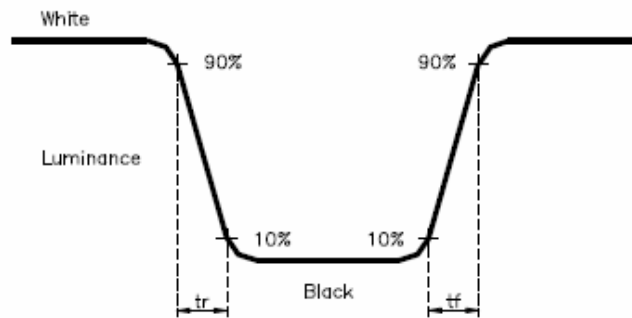

Note 5. Definition of view angle( $\theta$  ,  $\psi$ ) :

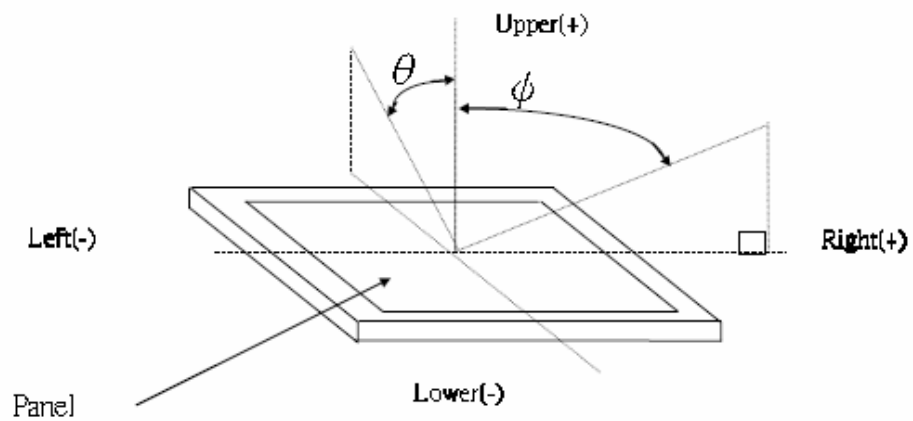

Note 6. Light source: C light.



## 10. Reliability Test Conditions and Methods

NO.	TEST ITEMS	TEST CONDITION	INSPECTION AFTER TEST
<input type="checkbox"/>	High Temperature Storage	80°C±2°C×200Hours	Inspection after 2~4hours storage at room temperature, the samples should be free from defects: 1, Air bubble in the LCD. 2, Seal leak. 3, Non-display. 4, Missing segments. 5, Glass crack. 6, Current IDD is twice higher than initial value. 7, The surface shall be free from damage. 8, The electric characteristic requirements shall be satisfied.
<input type="checkbox"/>	Low Temperature Storage	-30°C±2°C×200Hours	
<input type="checkbox"/>	High Temperature Operating	70°C±2°C×120Hours	
<input type="checkbox"/>	Low Temperature Operating	-20°C±2°C×120Hours	
<input type="checkbox"/>	Temperature Cycle(Storage)	$  \begin{array}{ccccc}  -20^{\circ}\text{C} & \longleftrightarrow & 25^{\circ}\text{C} & \longleftrightarrow & 70^{\circ}\text{C} \\  (30\text{min}) & & (5\text{min}) & & (30\text{min}) \\  & & \longleftarrow & & \longrightarrow \\  & & \text{1cycle} & & \\  & & \text{Total 10cycle} & &   \end{array}  $	
<input type="checkbox"/>	Damp Proof Test (Storage)	50°C±5°C×90%RH×120Hours	
<input type="checkbox"/>	Vibration Test	Frequency:10Hz~55Hz~10Hz Amplitude:1.5M X,Y,Z direction for total 3hours (Packing Condition)	
<input type="checkbox"/>	Drooping Test	Drop to the ground from 1M height one time every side of carton. (Packing Condition)	
<input type="checkbox"/>	ESD Test	Voltage:±8KV,R:330Ω,C:150PF,Air Mode,10times	

**REMARK:**

- 1, The Test samples should be applied to only one test item.
- 2, Sample side for each test item is 5~10pcs.
- 3,For Damp Proof Test, Pure water(Resistance > 10MΩ)should be used.
- 4,In case of malfunction defect caused by ESD damage, if it would be recovered to normal state after resetting, it would be judge as a good part.
- 5, EL evaluation should be accepted from reliability test with humidity and temperature: Some defects such as black spot/blemish can happen by natural chemical reaction with humidity and Fluorescence EL has.
- 6, Failure Judgment Criterion: Basic Specification Electrical Characteristic, Mechanical Characteristic, Optical Characteristic.

## 11. Inspection Standard

This standard apply to C-STN/TFT module

### 1. Spot check plan:

According to spot check level II ,MIL-STD-105D Level II ,the rank of accept or reject is below:

3A、 2A : major non-conformance : AQL 0.25 minor non-conformance : AQL 0.4

1A : major non-conformance : AQL 0.65      minor non-conformance : AQL 1.

### 2. Inspection condition:

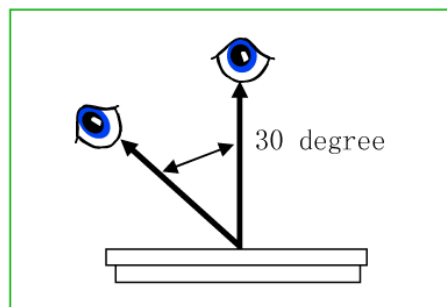

Under daylight lamp 20~40W, product distance inspector 'eye 30cm,incline degree 30°.

### 3. LCD area define:

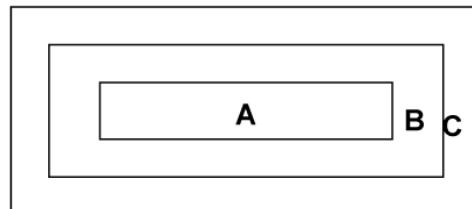

Area A: display area

Area B: VA area

Area C: out of VA area, not in sight after assembly

Remark: non-conformance at area C, but is OK that isn't influence reliability of product & assembly by customer.

## 4. Inspection standard

### 4.1 Major non-conformance

NO.	Item	Inspection standard	Rate
4.1.1	Function non-conformance	1) No display, display abnormally 2) Miss line, short 3) B/L no function or function abnormally 4) TP no function	<b>major</b>
4.1.2	miss	No matter miss what component	
4.1.3	Out of size	Module dimension out of spec	

### 4.2 Appearance non-conformance

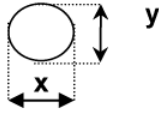
NO.	Item	Inspection standard	Rate																														
4.2.1	Black or white spot (power on)	dot non-conformance define $\Phi$ <div style="display: flex; align-items: center; justify-content: center; margin-top: 10px;"> <math display="block">\Phi = \frac{x+y}{2}</math>  </div>	Minor																														
		<b>A grade</b> <table border="1" style="width: 100%; border-collapse: collapse; margin-top: 10px;"> <thead> <tr> <th rowspan="2" style="width: 30%;">area size (mm)</th> <th colspan="3">Most approve q'ty</th> </tr> <tr> <th style="width: 15%;">A</th> <th style="width: 15%;">B</th> <th style="width: 15%;">C</th> </tr> </thead> <tbody> <tr> <td><math>\Phi \leq 0.10</math></td> <td colspan="3" style="text-align: center;">ignore</td> </tr> <tr> <td><math>0.10 &lt; \Phi \leq 0.15</math></td> <td colspan="3" style="text-align: center;">4</td> </tr> <tr> <td><math>0.15 &lt; \Phi \leq 0.20</math></td> <td colspan="3" style="text-align: center;">2</td> </tr> <tr> <td><math>0.20 &lt; \Phi \leq 0.25</math></td> <td colspan="3" style="text-align: center;">1</td> </tr> <tr> <td><math>0.25 &lt; \Phi</math></td> <td colspan="3" style="text-align: center;">0</td> </tr> </tbody> </table> <p style="margin-top: 10px;"><b>Most approve 4 damages, dot to dot <math>\geq 10\text{mm}</math></b></p>		area size (mm)	Most approve q'ty			A	B	C	$\Phi \leq 0.10$	ignore			$0.10 < \Phi \leq 0.15$	4			$0.15 < \Phi \leq 0.20$	2			$0.20 < \Phi \leq 0.25$	1			$0.25 < \Phi$	0					
area size (mm)	Most approve q'ty																																
	A	B	C																														
$\Phi \leq 0.10$	ignore																																
$0.10 < \Phi \leq 0.15$	4																																
$0.15 < \Phi \leq 0.20$	2																																
$0.20 < \Phi \leq 0.25$	1																																
$0.25 < \Phi$	0																																
4.2.2	Black or white line (power on)	<b>A grade</b> <table border="1" style="width: 100%; border-collapse: collapse; margin-top: 10px;"> <thead> <tr> <th colspan="2">Size(mm)</th> <th colspan="3">Most approve q'ty</th> </tr> <tr> <th style="width: 20%;">L(length)</th> <th style="width: 20%;">W(width)</th> <th style="width: 15%;">A</th> <th style="width: 15%;">B</th> <th style="width: 15%;">C</th> </tr> </thead> <tbody> <tr> <td>ignore</td> <td><math>W \leq 0.03</math></td> <td colspan="3" style="text-align: center;">ignore</td> </tr> <tr> <td><math>L \leq 5.0</math></td> <td><math>0.03 &lt; W \leq 0.05</math></td> <td colspan="3" style="text-align: center;">3</td> </tr> <tr> <td><math>L \leq 3.0</math></td> <td><math>0.05 &lt; W \leq 0.07</math></td> <td colspan="3" style="text-align: center;">2</td> </tr> <tr> <td></td> <td><math>0.07 &lt; W</math></td> <td colspan="3" style="text-align: center;">Treat with dot non-conformance</td> </tr> </tbody> </table> <p style="margin-top: 10px;"><b>Most approve 3 damages, line to line <math>\geq 10\text{mm}</math></b></p>	Size(mm)		Most approve q'ty			L(length)	W(width)	A	B	C	ignore	$W \leq 0.03$	ignore			$L \leq 5.0$	$0.03 < W \leq 0.05$	3			$L \leq 3.0$	$0.05 < W \leq 0.07$	2				$0.07 < W$	Treat with dot non-conformance			Minor
Size(mm)		Most approve q'ty																															
L(length)	W(width)	A	B	C																													
ignore	$W \leq 0.03$	ignore																															
$L \leq 5.0$	$0.03 < W \leq 0.05$	3																															
$L \leq 3.0$	$0.05 < W \leq 0.07$	2																															
	$0.07 < W$	Treat with dot non-conformance																															

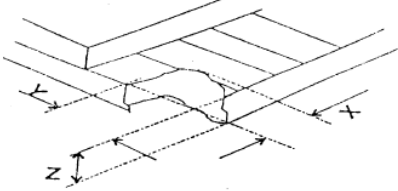
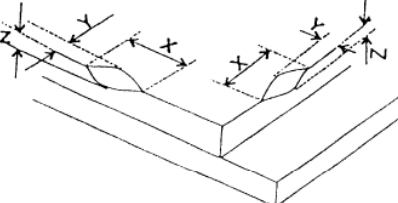
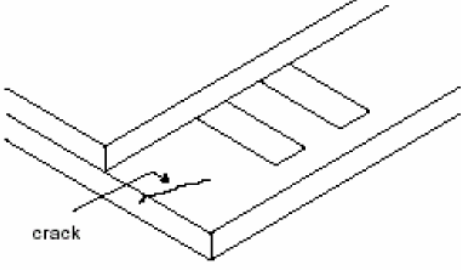
4.2.3	Polarizer position	1) Polarizer attach meet drawing, disallow out of LCD. 2) Polarizer must cover display area (special require unless)	Minor												
4.2.4	LCD non-conformance	<p>(i) crash at side (remark: S=ITO length)</p>  <table border="1" data-bbox="609 674 1179 788"> <thead> <tr> <th>X</th> <th>Y</th> <th>Z</th> </tr> </thead> <tbody> <tr> <td>≤3.0</td> <td>≤S</td> <td>ignore</td> </tr> </tbody> </table> <p>Crash disallow extend to ITO or seal.</p> <p>(ii) commonly surface scathe</p>  <table border="1" data-bbox="588 1133 1198 1247"> <thead> <tr> <th>X</th> <th>Y</th> <th>Z</th> </tr> </thead> <tbody> <tr> <td>≤2.0</td> <td>&lt;frame edge</td> <td>ignore</td> </tr> </tbody> </table> <p>(iii) crack</p> <p>Disallow extend crack</p> 	X	Y	Z	≤3.0	≤S	ignore	X	Y	Z	≤2.0	<frame edge	ignore	Minor
X	Y	Z													
≤3.0	≤S	ignore													
X	Y	Z													
≤2.0	<frame edge	ignore													
4.2.5	Contrast voltage warp	VOP/Vlcd voltage of confirmed sample ±0.15V	Minor												
4.2.6	color	Color & luminance of module scope reference spec	Minor												
4.2.7	Cross talk	Reference confirmed limit sample	Minor												

## 12. Handling Precautions

### 12.1 Mounting method

The LCD panel of AMSON TFT module consists of two thin glass plates with polarizers which easily be damaged. And since the module is so constructed as to be fixed by utilizing fitting holes in the printed circuit board.

Extreme care should be needed when handling the LCD modules.

### 12.2 Caution of LCD handling and cleaning

When cleaning the display surface, Use soft cloth with solvent

[Recommended below] and wipe lightly

- Isopropyl alcohol
- Ethyl alcohol

Do not wipe the display surface with dry or hard materials that will damage the polarizer surface.

Do not use the following solvent:

- Water
- Aromatics

Do not wipe ITO pad area with the dry or hard materials that will damage the ITO patterns

Do not use the following solvent on the pad or prevent it from being contaminated:

- Soldering flux
- Chlorine (Cl) , Sulfur (S)

If goods were sent without being silicon coated on the pad, ITO patterns could be damaged due to the corrosion as time goes on.

If ITO corrosion happens by miss-handling or using some materials such as Chlorine (Cl), Sulfur (S) from customer, Responsibility is on customer.

### 12.3 Caution against static charge

The LCD module uses C-MOS LSI drivers, so we recommend that you:

Connect any unused input terminal to VDDIO or GND, do not input any signals before power is turned on, and ground your body, work/assembly areas, and assembly equipment to protect against static electricity.

### 12.4 packing

- Module employs LCD elements and must be treated as such.
- Avoid intense shock and falls from a height.
- To prevent modules from degradation, do not operate or store them exposed direct to sunshine or high temperature/humidity

### 12.5 Caution for operation

- It is an indispensable condition to drive LCD's within the specified voltage limit since the higher voltage than the limit causes the shorter LCD life.
- An electrochemical reaction due to direct current causes LCD's undesirable deterioration, so that the use of direct current drive should be avoided.
- Response time will be extremely delayed at lower temperature than the operating temperature range and on the other hand at higher temperature LCD's show dark color in them. However those phenomena do not mean malfunction or out of order with LCD's, which will come back in the specified operation temperature.
- If the display area is pushed hard during operation, some font will be abnormally displayed but it resumes normal condition after turning off once.
- Slight dew depositing on terminals is a cause for electro-chemical reaction resulting in terminal open circuit.

Usage under the maximum operating temperature, 50%Rh or less is required.

## 12.6 storing

In the case of storing for a long period of time for instance, for years for the purpose or replacement use, the following ways are recommended.

- Storage in a polyethylene bag with the opening sealed so as not to enter fresh air outside in it. And with no desiccant.
- Placing in a dark place where neither exposure to direct sunlight nor light's keeping the storage temperature range.
- Storing with no touch on polarizer surface by the anything else.  
[It is recommended to store them as they have been contained in the inner container at the time of delivery from us.]

## 12.7 Safety

- It is recommendable to crash damaged or unnecessary LCD's into pieces and wash off liquid crystal by either of solvents such as acetone and ethanol, which should be burned up later.
- When any liquid leaked out of a damaged glass cell comes in contact with your hands, please wash it off well with soap and water.

## 13. Precaution for Use

### 13.1

A limit sample should be provided by the both parties on an occasion when the both parties agreed its necessity. Judgment by a limit sample shall take effect after the limit sample has been established and confirmed by the both parties.

### 13.2

On the following occasions, the handing of problem should be decided through discussion and agreement between responsible of the both parties.

- When a question is arisen in this specification.
- When a new problem is arisen this is not specified in this specification.
- When an inspection specifications change or operating condition change in customer is reported to AMSON TFT and some problem is arisen in this specification due to the change.
- When a new problem is arisen at the customer's operating set for sample evaluation in the customer site.

### 14. Packing Method

