

Specification for Approval

Customer: _____

Model Name: _____

Supplier Approval			Customer approval
R&D Designed	R&D Approved	QC Approved	
<i>Peter</i>	<i>Peng Jun</i>		

Table of Contents

List	Description	Page No.
	Cover	1
	Revision Record	2
	Table of Contents	3
1	Features & Mechanical Specifications	4
2	Dimensional Outline	5
3	Pin Description	6
4	Absolute Maximum Ratings	7
5	Electrical Characteristics	7
6	Backlight Characteristics	7
7	Electro-Optical Characteristics	8
8	MIPI Electrical Characteristics	11
9	Quality Specifications	14
10	Reliability of LCM	21
11	Precaution for using LCD/LCM	21

1. Features & Mechanical Specifications

Item	Contents	Unit
	LCD	
LCD Type	TFT / Transmissive / Normally Black	--
Size	8.0	
Viewing direction	Full view	--
Backlight	White LED x 21	--
Interface	4 Lanes MIPI Interface	--
Outline Dimension	114.6(W) × 184.1(H) × 2.6(T)	mm
Glass area (W×H×T)	112.64× 181.80× 0.8	mm
Active area (W×H)	107.64× 172.22	mm
Number of Dots	800(RGB) × 1280	--
Operating Temperature	-10 ~ +50	°C
Storage temperature	-20 ~ +60	°C
Polarizer	Top: IPS film	--
	Bottom: IPS film	

2. Dimensional Outline

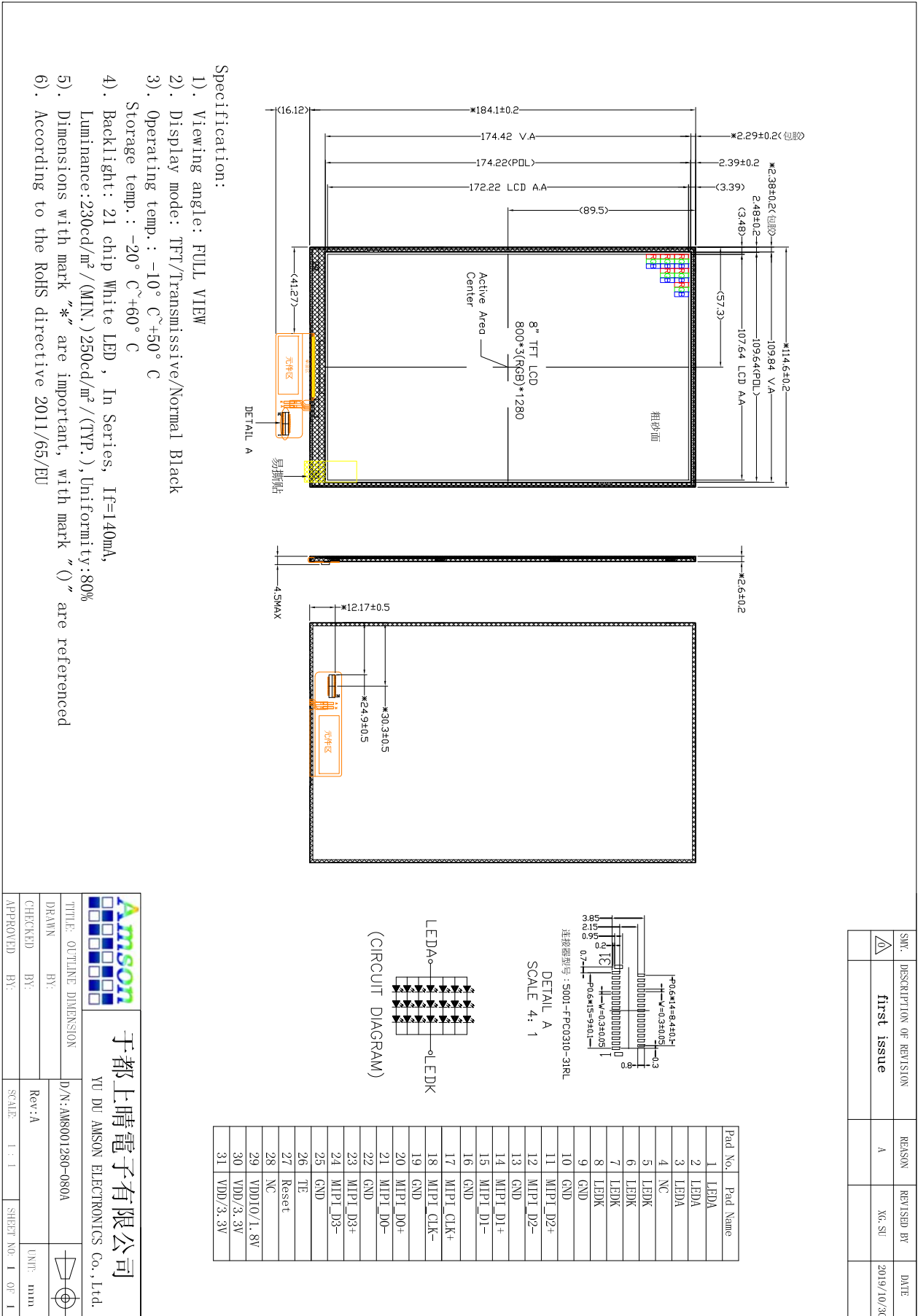

SMV	DESCRIPTION OF REVISION	REASON	REVISED BY	DATE
△	first issue	A	XG.SI	2019/10/30

于都上晴电子有限公司
YU DU AMSON ELECTRONICS Co., Ltd.

于都上晴电子有限公司

YU DU AMSON ELECTRONICS Co., Ltd.

D/N: AM8001280-080A

Rev: A

SCALE: 1:1

SHEET NO: 1 OF 1

DATE: 2019/10/30

3. Pin Description

PIN NO.	PIN NAME	DESCRIPTION
1,2,3	LEDA	Anode for light bar
4	NC	NC
5,6,7,8	LEDK	Cathode for light bar
9	GND	Ground
10	GND	Ground
11	MIPI_D2+	MIPI differential data2 input(Positive)
12	MIPI_D2-	MIPI differential data2 input(Negative)
13	GND	Ground
14	MIPI_D1+	MIPI differential data1 input(Positive)
15	MIPI_D1-	MIPI differential data1 input(Negative)
16	GND	Ground
17	MIPI_CLK+	MIPI differential clock input(Positive)
18	MIPI_CLK-	MIPI differential clock input(Negative)
19	GND	Ground
20	MIPI_D0+	MIPI differential data0 input(Positive)
21	MIPI_D0-	MIPI differential data0 input(Negative)
22	GND	Ground
23	MIPI_D3+	MIPI differential data3 input(Positive)
24	MIPI_D3-	MIPI differential data3 input(Negative)
25	GND	Ground
26	TE	Tearing Effect pin.
27	RESET	Device reset signal
28	GND	Ground
29	VDDIO 1.8V	1.8V input
30	VDD 3.3V	3.3V input
31	VDD 3.3V	3.3V input

4. Absolute Maximum Ratings

Item	Symbol	Rating	Unit
Digital Supply Voltage	VDD	-0.3 to +4.0	V
Operating Temperature range	TOP	-10 to +50	°C
Storage Temperature range	TST	-20 to +60	°C

5. Electrical Characteristics

DC Characteristics

Item	Symbol	Min.	Type.	Max.	Unit
Digital Power Supply Voltage	VDD	3.0	3.3	3.6	V
	VDDIO	1.7	1.8	1.9	

6. Backlight Characteristics

(White LED × 3 in series) × 9 in Parallel

(Ta = 25°C)

Item	Symbol	Condition	Min	Typ	Max	Unit
Forward Voltage	VF	IF=140~150mA	9.0	9.6	10.8	V
Uniformity	△Bp	-	80	-	-	%
LCM Luminance	Lv	IF=140~150mA	230	250	-	cd/m ²

7. Electro-Optical Characteristics

The relative measurement methods of optical characteristics are shown as below.
The following items should be measured under the test conditions described in

Item	Symbol	Condition	Value			Unit	Note	
			Min	Typ	Max			
Uniformity	ΔBp		70	80	-	%	Note 6	
Viewing Angle	Left	θL	Cr \geq 10	-	85	-	deg	Note1
	Right	θR		-	85	-		
	Top	ψT		-	85	-		
	Bottom	ψB		-	85	-		
Contrast Ratio	Cr	$\theta=0$	700	900	-		Note 4	
Response Time	Tr+Tf	$=0$	-	11	-	ms	Note 3	
Color Coordinate of CIE1931	Red	X	$\theta=0$ $=0$	-	TBD	-	+/-0.03	Note 2.5.6
		y		-	TBD	-		
	Green	X		-	TBD	-		
		y		-	TBD	-		
	Blue	X		-	TBD	-		
		y		-	TBD	-		
	White	X		-	TBD	-		
		y		-	TBD	-		

Note 1: Definition of viewing angle range

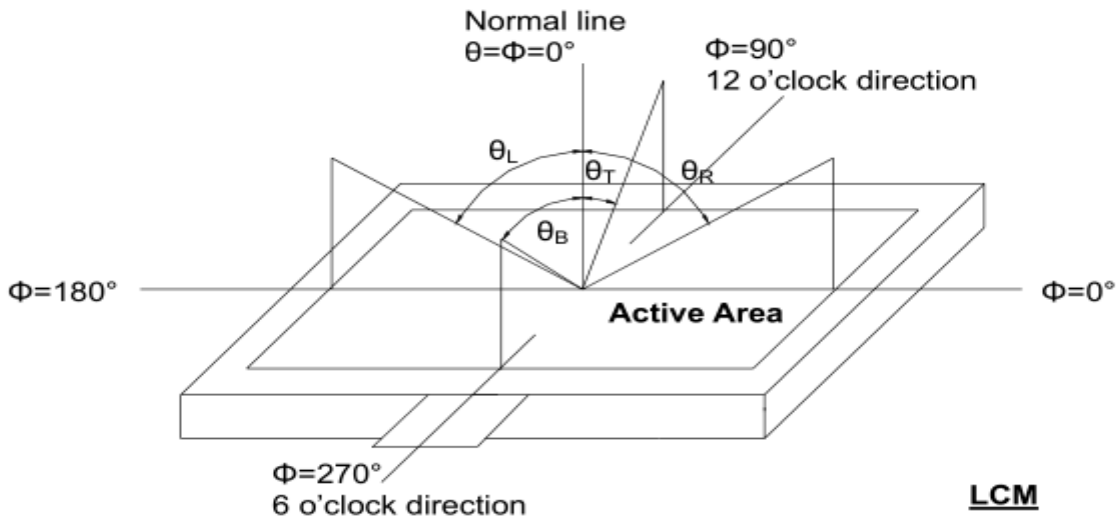
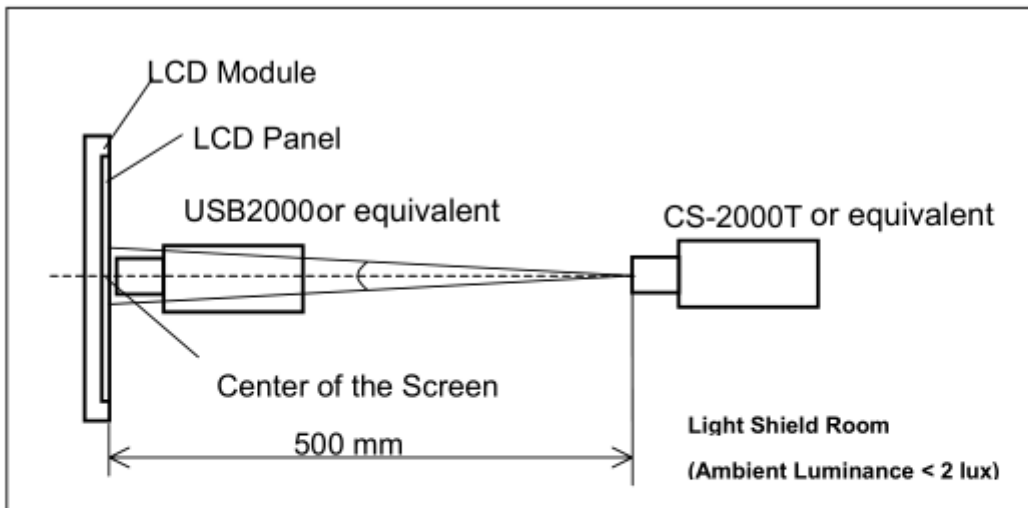

Fig. 4-1 Definition of viewing angle

Note 2: Definition of optical measurement system.

The optical characteristics should be measured in dark room. After 30 minutes operation, the optical properties are measured at the center point of the LCD screen. (Viewing angle is measured by ELDIM-EZ contrast/Height : 1.2mm, Response time is measured by Photo detector TOPCON BM-7, other items are measured by BM-5A/ Field of view: 1° /Height: 500mm.)



Note 3: Definition of Response time

The response time is defined as the LCD optical switching time interval between "White" state and "Black" state. Rise time (T_{ON}) is the time between photo detector output intensity changed from 90% to 10%. And fall time (T_{OFF}) is the time between photo detector output intensity changed from 10% to 90%.

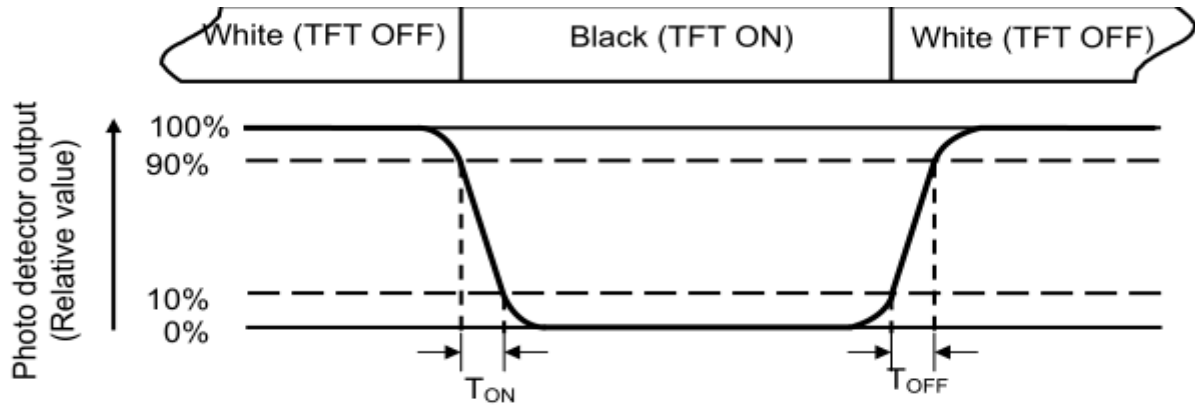

Fig. 4-3 Definition of response time

Note 4: Definition of contrast ratio

$$\text{Contrast ratio (CR)} = \frac{\text{Luminance measured when LCD on the "White" state}}{\text{Luminance measured when LCD on the "Black" state}}$$

Note 5: Definition of color chromaticity (CIE1931)

Color coordinates measured at center point of LCD.

Note 6: All input terminals LCD panel must be ground while measuring the center area of the panel.

Note 7: Definition of Luminance Uniformity

Active area is divided into 9 measuring areas (Refer to Fig. 4-4).Every measuring point is placed at the center of each measuring area.

$$\text{Luminance Uniformity (Yu)} = \frac{B_{min}}{B_{max}}$$

L-----Active area length W---- Active area width

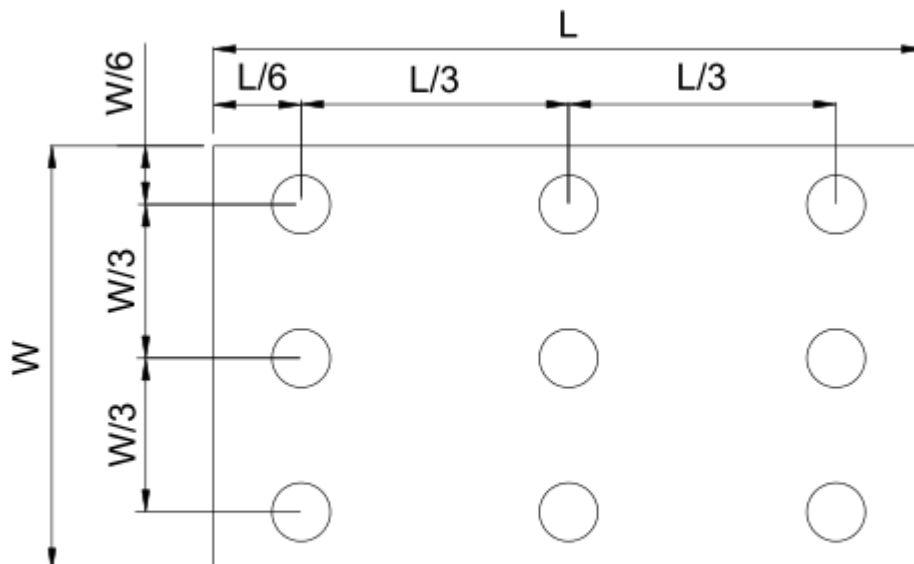

Fig. 4-4 Definition of measuring points

B_{max} : The measured maximum luminance of all measurement position.

B_{min} : The measured minimum luminance of all measurement position.

8. MIPI Electrical Characteristics

8.1 DC Characteristics for DSI LP Mode

DC levels of the LP-00, LP-01, LP-10 and LP-11 are defined in the table below: DC Characteristics for the DSI LP mode when LP-RX, LP-CD or LP-TX is mentioned in the condition column. Other logical levels in the table are for MCU interface.

Parameter	Symbol	Condition	Specification			Unit
			Min.	Typ.	Max.	
Logic 1 output voltage	V_{OH}	$I_{OUT}=-1mA$, Note 2	TBD	-	TBD	V
Logic 0 output voltage	V_{OL}	$I_{OUT}=1mA$, Note 2	TBD	-	TBD	V
Logic 1 input voltage	V_{IHLPCD}	LP-CD, Note 3	TBD	-	TBD	mV
Logic 0 input voltage	V_{ILLPCD}	LP-CD, Note 3	TBD	-	TBD	mV
Logic 1 input voltage	V_{IHLPRX}	LP-RX (CLK, D0 ,D1, D2, D3), Note 3	TBD	-	TBD	mV
Logic 0 input voltage	V_{ILLPRX}	LP-RX (CLK, D0 ,D1, D2, D3), Note 3	TBD	-	TBD	mV
Logic 0 input voltage	$V_{ILLPRXULP}$	LP-RX (CLK ULP mode), Note 3	TBD	-	TBD	mV
Logic 1 output voltage	V_{OHLPTX}	LP-TX (D0), Note 3	TBD	TBD	TBD	V
Logic 0 output voltage	V_{OLLPTX}	LP-TX (D0), Note 3	TBD	-	TBD	mV
Logic 1 input current	I_{IH}	LP-CD, LP-RX, Note 3	-	-	TBD	uA
Logic 0 input current	I_{IL}	LP-CD, LP-RX, Note 3	TBD	-	-	uA

Notes:

1. $T_a = -30^{\circ}C$ to $70^{\circ}C$ (to $+85^{\circ}C$ no damage)
2. BC, TE, PANEL_TE
3. DSI High Speed mode is off.

For General Custom

8.2 DC Characteristics for DSI HS Mode

Parameter	Symbol	Condition	Specification			Unit
Input Common Mode Voltage for Clock	V_{CMCLK}	CLKP/N Note 2, Note 3	TBD	-	TBD	mV
Input Common Mode Voltage for Data	V_{CMDATA}	DnP/N Note 2, Note 3, Note 5	TBD	-	TBD	mV
Common Mode Ripple for Clock Equal or Less than 450MHz	$V_{CMRCLK450}$	CLKP/N Note 4	TBD	-	TBD	mV
Common Mode Ripple for Data Equal or Less than 450MHz	$V_{CMRDATAL450}$	DnP/N Note 4, Note 5	TBD	-	TBD	mV
Common Mode Ripple for Clock More than 450MHz (peak sine wave)	$V_{CMRCLKM450}$	CLKP/N	-	-	TBD	mV
Common Mode Ripple for Data More than 450MHz (peak sine wave)	$V_{CMRDATAM450}$	DnP/N Note 5	-	-	TBD	mV
Differential Input Low Level Threshold Voltage for Clock	V_{THCLK-}	CLKP/N	TBD	-	-	mV
Differential Input Low Level Threshold Voltage for Data	$V_{THDATA-}$	DnP/N Note 5	TBD	-	-	mV
Differential Input High Level Threshold Voltage for Clock	V_{THCLK+}	CLKP/N	-	-	TBD	mV
Differential Input High Level Threshold Voltage for Data	$V_{THDATA+}$	DnP/N Note 5	-	-	TBD	mV
Single-ended Input Low Voltage	V_{ILHS}	CLKP/N, DnP/N Note 3, Note 5	TBD	-	-	mV
Single-ended Input High Voltage	V_{IHHS}	CLKP/N, DnP/N Note 3, Note 5	-	-	TBD	mV
Differential Termination Resistor	R_{TERM}	CLKP/N, DnP/N Note 5	TBD	TBD	TBD	Ω
Single-ended Threshold Voltage for Termination Enable	V_{TERDEN}	CLKP/N, DnP/N Note 5	-	-	TBD	mV
Termination Capacitor	C_{TERM}	CLKP/N, DnP/N Note 5, Note 6	-	-	TBD	pF

Notes:

1. $T_a = -30^{\circ}\text{C}$ to 70°C (to $+85^{\circ}\text{C}$ no damage), $V_{CI} = 2.5\text{V}$ to 3.3V , $V_{DD3} = V_{DD3_M} = 1.65\text{V}$ to 3.3V
2. Includes 50mV (-50mV to 50mV) ground difference
3. Without $V_{CMRCLK450}/V_{CMRDATAL450}$
4. Without 50mV (-50mV to 50mV) ground difference
5. $n = 0$ and 1
6. For higher bit rates, a 14pF capacitor will be needed to meet the common-mode return loss specification.

8.3 High Speed Mode-Data Clock Channel Timing

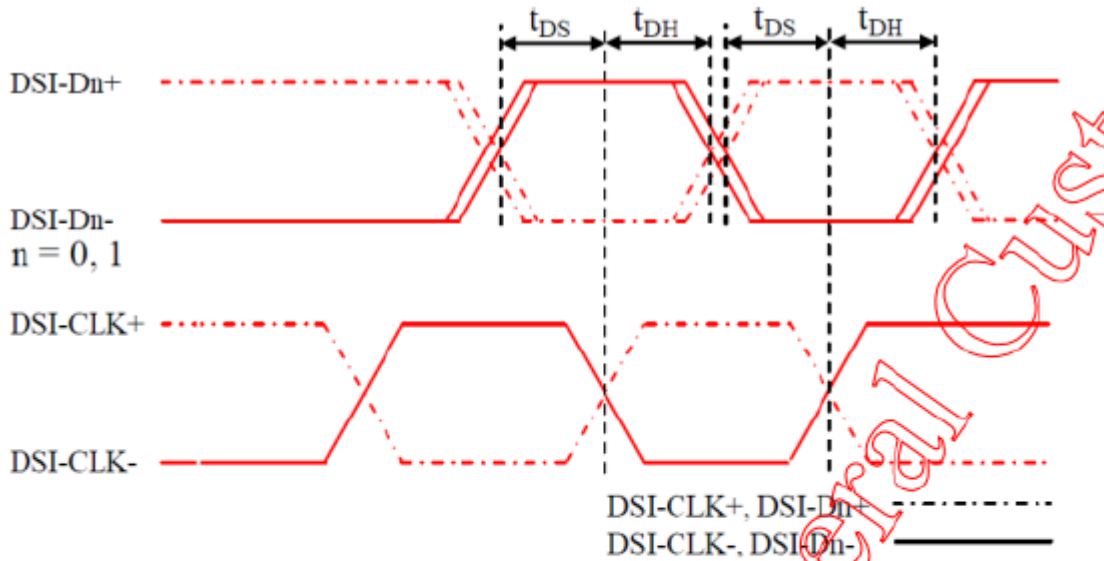

DSI Data to Clock Channel Timings

DSI Data to Clock Channel Timings

Signal	Symbol	Parameter	Min	Max
DnP/N , n=0 and 1	t_{DS}	Data to Clock Setup time	TBD	-
	t_{DH}	Clock to Data Hold Time	TBD	-

8.4 High Speed Mode-Rising and Falling Timing

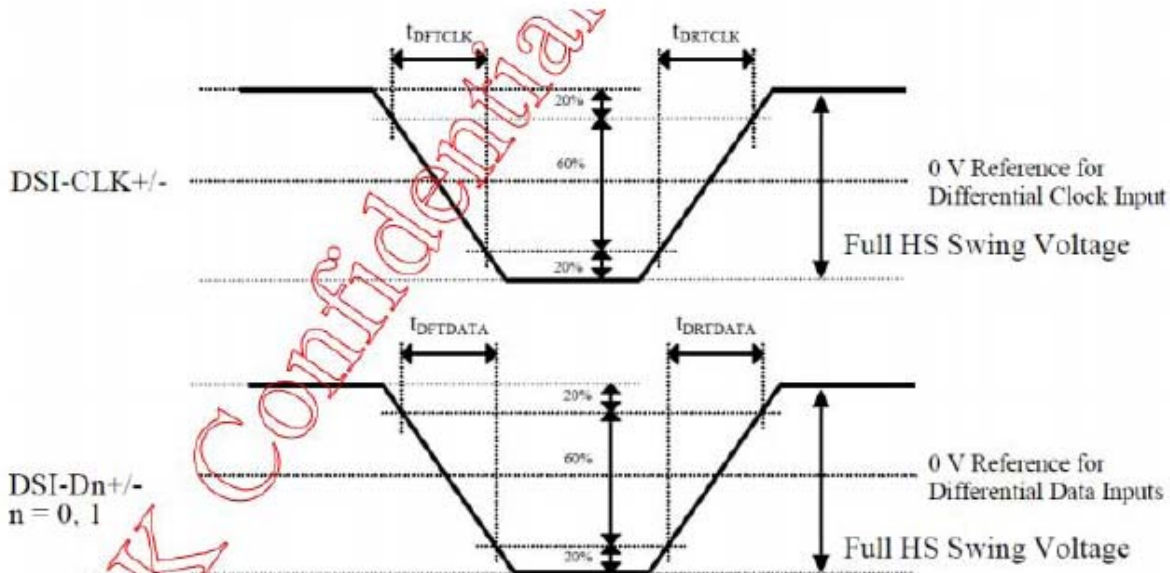

Rising and Falling Timings on Clock and Data Channels

9. Quality Specifications

All The raw material are Rohs compliant.

9.1 Standard of the product appearance test

9.1.1 通常在 $22\pm 3^{\circ}\text{C}$ ， $50\pm 10\%\text{RH}$ 的环境，光强度 $350\text{-}700\text{Lux}$ 下（20W 日光灯,40cm 距离左右）检验员的眼睛与模块之间的距离为 $35\text{cm}\pm 5\text{cm}$ ，LCD下面用背光源来检查（见图 4）



图 4)

9.1.2 模块目视检验方向，按图纸规定视角方向偏离 LCD 平面法线 45° ；

9.1.3 采用裸眼检查，检验者需戴好防静电手环、防静电手套；

9.1.4 功能测试时，产品在正常显示时用棉签或手指轻轻按压 FPC 邦定处、电子元件处、背光源焊接处，检查是否存在不稳定现象。

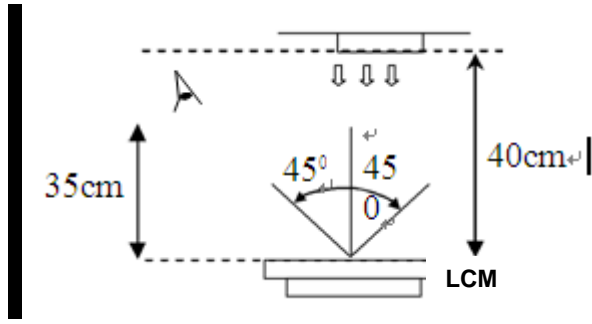
9.2、不良项目和验收标准



9.2.1 尺寸：对整体外形尺寸及各元件位置关系尺寸，需符合技术图纸要求，属主要缺点。

9.2.2 电性测试：

序号	项目	说明（判定标准）	Max	Min
1	缺划	显示画面时出现横/竖线、某段或“十”字缺失不良	✓	
2	不显	在正常测试情况下，无画面显示。	✓	
3	显示异常	在正常测试情况下，显示的图案或图案顺序与要求不符。	✓	
4	视角错	LCD 显示视角与要求（或参照客户承认样品）不一致	✓	
5	对比度差（朦图、鬼影）	在正常显示画面时偏淡或非显示画面时有微现的现象，此判定参照限度样品。		✓
6	响应速度慢	点在正常测试情况下，产品的逐一画面或亮或某段显示的反应速度与其它部分或样品不一致。		✓
7	电流大	点亮产品时电流大，导致测试自动关闭	✓	
8	短路	出现 Seg-Seg、Com-Com 或 Seg-Com ITO 走线之间相连接的现象	✓	
9	深线/暗划	在正常电压条件下显示的笔画比对样品深浅不一		✓
10	多余划	在正常测试情况下，不该显示的符号或行、列、走线显示。	✓	

9.3. LCD 部分

9.3.1 TFT 特别检查

检查项目	可接受标准	图表
1. 像素缺陷的定义	像素/3个元素(R+G+B)	
	点/1个元素(R/G/B)	
	亮点: 与周围邻近 pixel 对比较亮的点为亮点, 超过一个 sub pixel 面积的 1/2 时计为一个亮点. 颜色有红、绿、蓝三种, 亮点可在 R、G、B 三个画面中的两个画面可视, 在全白画面不可视;	
	暗点: 与周围邻近 pixel 对比较暗的点为暗点, 超过一个 sub pixel 面积的 1/2 时计为一个暗点. 颜色为暗黑色, 暗点在 R、G、B 三个画面中的一个画面可视, 在全白画面不可视;	
相邻点的定义: 2个或3个点连续元素点(R+G/G+B/B+R/R+G+B).		

2. 点缺陷判定标准	目视测量卡	失效模式		可接受判定标准	
		点的形式	数量	点的形式	数量
亮点		任何(红, 蓝, 绿)	1	任何(红, 蓝, 绿)	1
		2个相邻点	0	2个相邻点	0
		暗点	2	暗点	2
暗点		2个相邻点	1	2个相邻点	1
		三个或三个以上相邻的点	0	三个或三个以上相邻的点	0

Note: 亮点/暗点 A区 0.15MM 允许 2个 (间距 ≥ 10 MM), B区最大不能超过 0.30mm 允许 2个 (间距 ≥ 10 MM)

(LCD 点 $\varphi \leq 0.3$ 为 A 品可正常出货)

(LCD 点 $0.3 < \varphi < 0.5$ MM 为 A-规, $\varphi \geq 0.5$ 为 B 规 分类入 B 品仓)

9.3.2 一般检查内容:

不良项目	检查标准 (单位:mm)	允收标准 (单位: 个/N)	Max	Min
1. 划伤/毛线	$W \leq 0.03$	不计		√
	$0.03 < W \leq 0.05 \quad L \leq 4.0$	$N \leq 2$ (间距 $\geq 10\text{MM}$)		
	$0.05 < W \leq 0.07 \quad L \leq 4.0$	$N \leq 1$		
	$W > 0.07$ 或 $L > 4.0$	不允许		
2. 偏光片凹凸点	$\phi \leq 0.15$	不计 (间距 $\geq 10\text{MM}$)		√
	$0.15 < \phi \leq 0.2$	忽略不计 (不可串污)		
	$0.2 < \phi \leq 0.3$	$N \leq 3$ (间距 $\geq 10\text{MM}$)		
	$\phi > 0.3$	NG		
3. 偏光片压痕、边缘气泡、水纹	POL压痕/边缘气泡/水纹不良未进黑边框1/2位置, 判定OK; 超过黑边框1/2位置, 判定NG.			√
4. 清晰点状 (片异物/片气泡/片白点/BL异物/BL白点/印等) 缺陷	$\phi \leq 0.15$	忽略不计 (不可串污)		√
	$0.15 < \phi \leq 0.25$	A区不允许 B区 $N \leq 2$		
	$\phi > 0.25$	NG		
	备注: LCM制程中的点缺陷原则上可去除的点需要全部擦除, 如有必须符合以上规格			
5. 模糊点状 (片异物/片气泡/片白点/BL异物/BL白点)	$\phi \leq 0.15$	忽略不计 (不允许密集)		√
	$0.15 < \phi \leq 0.30$	$N \leq 2$ (间距 $\geq 10\text{MM}$)		√
	$\phi > 0.3$	NG		
	备注: LCM制程中的点缺陷原则上可去除的点需要全部擦除, 如有必须符合以上规格			

9.3.3 其它

3.3 共七

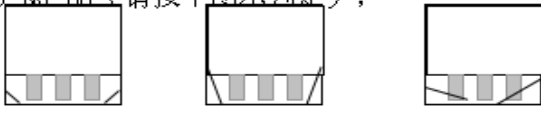
项目	说明 (判定标准)	Max	Mi
1. LCD 破角	LCD 破角不崩及 ITO 走线, 即不影响产品功能显示的产品, 同时不影响成品的外观时判定为OK, 如出现裂痕现象, 且涉及到 ITO 走线, 即判定为 NG 品 (请按下图示判定);  OK 品 (未崩及走线) NG 品 (崩及到边框) NG 品 (崩及到走线)		✓
2. 漏液晶	LCD 盒内出现严重未注满液晶现象, 即判定为 NG 品;	✓	
	LCD 盒内边框四周出点状的未注满液晶现象, 且不影响功能显示和外观的产品, 判定为OK		✓
3. 白团、黑团、 Murru	由于 LCD 盒内污染或盒厚问题, 导致在显示时此处的颜色与周围的颜色出现不同的现象, 在正常视角观察, 不能清晰看出此类不良现象的产品, 按5% ND进行判定(眼睛距离LCD 30 厘米, 手持ND距离眼睛5厘米确认时间2秒), 如为降规玻璃资源, 以不影响功能为判定合格。		✓
4. 偏光片位置	偏光片必须盖住所有显示区域, 且不允许超出 LCD 的边缘, 否则判定为 NG 品; 偏光片盖住主显示区, 且未有超出 LCD 边缘现象, 但有轻微偏斜现象, 不影响到成品的外时, 判定为OK	✓	
	产品的上下偏光片贴反, 即判定为 NG 品;		

9.4 背光部分

项目	说明 (判定标准)	Max	Min
1. 背光规格	背光组件规格需符合图纸与技术规格要求。	✓	
2. 灯不亮/颜色错	背光不亮、死暗灯不允许。	✓	
3. 颜色偏差	亮度、均匀度、电压、电流符合图纸的规格要求。		✓
4. 亮度偏差	A、点亮时产品与样品亮度不同, 经测量与图纸规格不符的拒收; B、对图纸未有规格偏差的, 按样品亮度的±30%范围控制。		✓
5. 闪烁	点亮时各亮点发光不可有闪烁现象, 点亮时各亮度需一致。	✓	
6. 亮斑/暗斑	点亮时灯仔处出现明显的亮、暗现象, 此判定参照签样。		✓
7. 背光翘	背光应紧密贴附在 LCD 上, 翘起的距离允许不超过边长的 1/3。		✓
8. 灯柱	依样品的限度样板判定。		✓

9.5 铁框部分

项目	说明 (判定标准)	Max	Min
1. 材质/表面处理	铁框材质/表面处理方式与规格不符的, 拒收。	√	
2. 扭脚不符	扭脚方式/方向错误, 漏扭脚, 拒收。	√	
3. 外观不良	A、表面不允许在明显的氧化、变色、凹点、划伤现象; B、组装后不允许翘起、变形等现象。		√
4. 毛边	铁框毛边过长进入可视区的		√

9.6 FPC/焊接部分

项目	说明 (判定标准)	Max	Min
1. FPC 不良	检查 FPC 上是否有少电子元件、电子元件是否有连锡现象、电子元件是否有松动、贴歪等不良现象。		√
2. 焊接不良	A、焊接位不允许出现冷焊, 假焊, 漏焊, 锡裂, 锡未溶解等不良现象, 否则拒收; B、焊接位的锡高不允许超过 0.2mm, 否则拒收。 C、焊接有效接触面积必须大于总焊接面的 2/3, 否则拒收 D、焊接引脚偏位不允许超过 1/3, 否则拒收	√	
3. 焊点形状	焊点应为内凹式, 不可形成包焊与锡量不足, 锡尖等, 否则拒收。		√
4. 外观不良	A、焊接残留的松香, 锡油呈黄褐色或焦黑色的, 拒收; B、FPC 上除焊接位外其它部位均不允许有锡球、锡渣, 否则拒收。 3、FPC 上除与 LCD 连接位外其它部位均不允许有硅胶, 否则拒收;		√

9.7 TP 部分

项目	说明 (判定标准)	Max	Min
1. 外观	A、气泡、凹凸点、脏污、划伤: 按 6.3.2 点、线不良标准判定; B、组装歪斜不允许超出背光的边缘, 否则拒收; C、正常观察角度发现牛顿环不良, 拒收		√
	D、不允许有裂痕现象, 否则拒收。	√	
2. 功能	A、无触摸, 拒收; B、触摸不良, 拒收; C、触摸屏焊接位不良按 6.6 的标准来检, 超标拒收	√	

9.8 总体外观

项目	说明 (判定标准)	Max	Min
1. 总体尺寸	成品的外形尺寸不满足图纸要求, 拒收。	√	
2. 总体外观	A、成品结构不满足图纸要求, 拒收; B、产品需要喷码, 而未喷码, 拒收。	√	
	C、有少物料现象, 拒收; D、成品表面有脏污, 残胶, 指纹等, 拒收; E、产品上的不良标记或标签未清除, 拒收; F、黑胶带不允许贴歪, 不允许贴到面玻璃上, 否则拒收; G、FPC 上不允许有压痕、严重折痕现象, 否则拒收; H、产品喷码字迹模糊不能识别, 拒收。		√
3. 组装	A、不允许有漏光现象 (依据情况可参照限样), 否则拒收; B、不允许有亮斑、暗斑等现象 (依据情况可参照样限样), 否则拒收。		√
4. 易撕贴	A、有要求贴易撕贴的, 漏贴或位置错的拒收; B、易撕贴无法撕起保护膜的, 拒收。		√
5. 硅胶	A、硅胶高度不允许超过面玻璃的高度, 否则拒收; B、硅胶必须覆盖住 IC, 否则拒收 (有特殊要求的, 按特殊要求执行); C、硅胶处不允许有气泡, 硅胶应覆盖住脚仔上所有的 ITO 走线。		√
6. 内产品包装	产品包装需与规格要求一致, 不得短缺, 多装与数量不符; 包装与出货标识与规格/订单要求需一致。	√	

9.9、包装

9.9.1 产品的内外包装方法参照图纸及设计要求来包装（图 9.1）。

9.9.2 如客户有特殊的包装要求，按客户的要求执行。

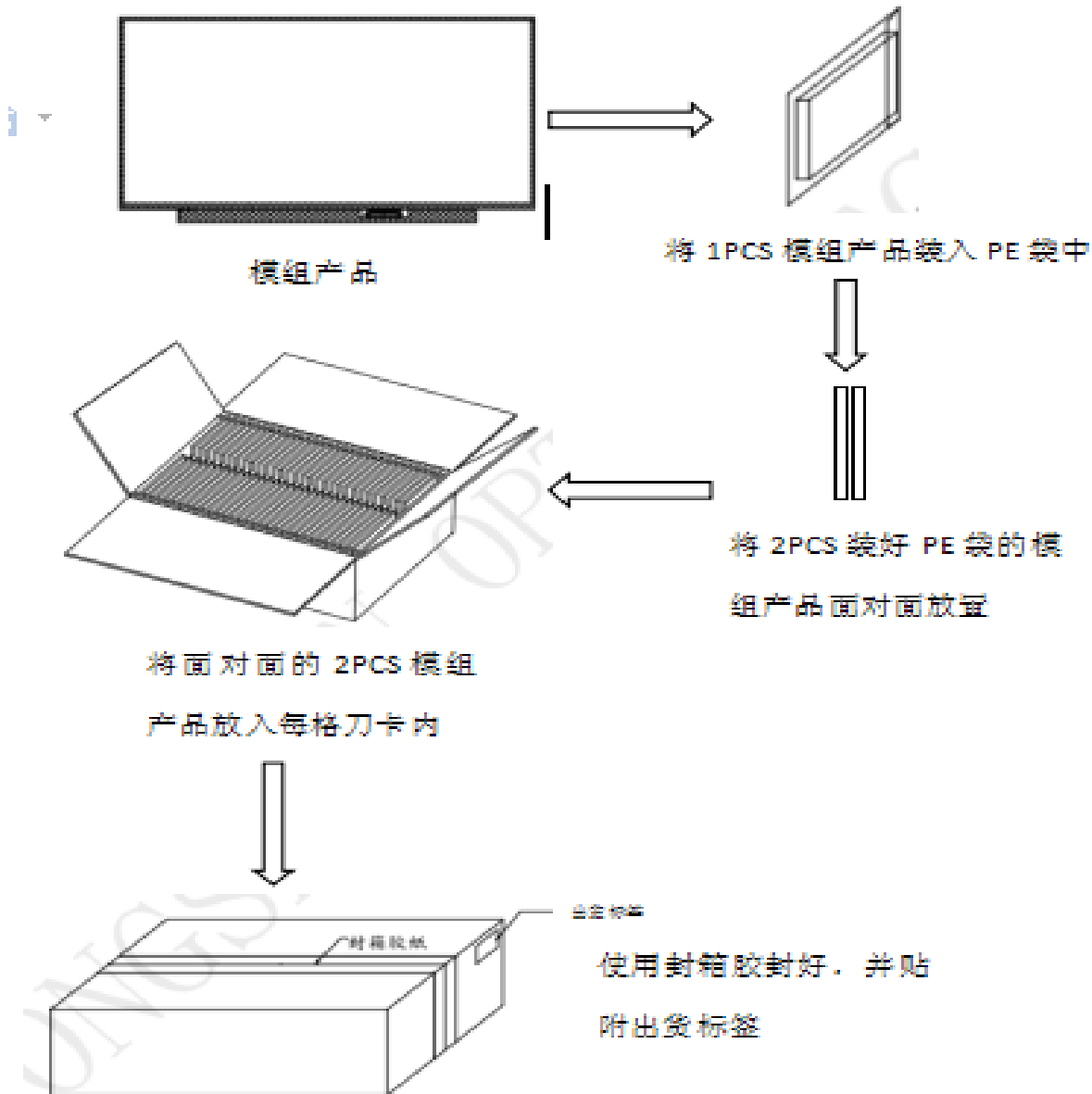

10. Reliability of LCM

Reliability test condition:

Item	Condition	Time (hrs)	Assessment
High temp. Storage	60°C	48	No abnormalities in functions and appearance
High temp. Operating	50°C	48	
Low temp. Storage	-20°C	48	
Low temp. Operating	-10°C	48	
Humidity	50°C/80%RH	48	

Note: the above experimental conditions need to assemble the finished product prototype in the experiment;

Recovery time should be 24 hours minimum. Moreover, functions, performance and appearance shall be free from remarkable deterioration within 50,000 hours under ordinary operating and storage conditions room temperature (23±2°C), normal humidity (below 45%~75% RH), and in the area not exposed to direct sun light.

11. Precaution for using LCD/LCM

LCD/LCM is assembled and adjusted with a high degree of precision. Do not attempt to make any alteration or modification. The followings should be noted.

General Precautions:

1. LCD panel is made of glass. Avoid excessive mechanical shock or applying strong pressure onto the surface of display area.
2. The polarizer used on the display surface is easily scratched and damaged. Extreme care should be taken when handling. To clean dust or dirt off the display surface, wipe gently with cotton, or other soft material soaked with isopropyl alcohol, ethyl alcohol or trichlorotrifluoroethane, do not use water, ketone or aromatics and never scrub hard.
3. Do not tamper in any way with the tabs on the metal frame.
4. Do not made any modification on the PCB without consulting XINPENG.
5. When mounting a LCM, make sure that the PCB is not under any stress such as bending or twisting. Elastomer contacts are very delicate and missing pixels could result from slight dislocation of any of the elements.
6. Avoid pressing on the metal bezel, otherwise the elastomer connector could be deformed and lose contact, resulting in missing pixels and also cause rainbow on the display.
7. Be careful not to touch or swallow liquid crystal that might leak from a damaged cell. Any liquid crystal adheres to skin or clothes, wash it off immediately with soap and water.

11.2 Static Electricity Precautions:

1. CMOS-LSI is used for the module circuit; therefore operators should be grounded whenever he/she comes into contact with the module.
2. Do not touch any of the conductive parts such as the LSI pads; the copper leads on the PCB and the interface terminals with any parts of the human body.
3. Do not touch the connection terminals of the display with bare hand; it will cause disconnection or defective insulation of terminals.
4. The modules should be kept in anti-static bags or other containers resistant to static for storage.
5. Only properly grounded soldering irons should be used.
6. If an electric screwdriver is used, it should be grounded and shielded to prevent sparks.
7. The normal static prevention measures should be observed for work clothes and working benches.
8. Since dry air is inductive to static, a relative humidity of 50-60% is recommended.

11.3 Soldering Precautions:

1. Soldering should be performed only on the I/O terminals.
2. Use soldering irons with proper grounding and no leakage.
3. Soldering temperature: $280^{\circ}\text{C}\pm 10^{\circ}\text{C}$
4. Soldering time: 3 to 4 second.
5. Use eutectic solder with resin flux filling.
6. If flux is used, the LCD surface should be protected to avoid spattering flux.
7. Flux residue should be removed.

11.4 Operation Precautions:

1. The viewing angle can be adjusted by varying the LCD driving voltage V_o .
2. Since applied DC voltage causes electro-chemical reactions, which deteriorate the display, the applied pulse waveform should be a symmetric waveform such that no DC component remains. Be sure to use the specified operating voltage.
3. Driving voltage should be kept within specified range; excess voltage will shorten display life.
4. Response time increases with decrease in temperature.
5. Display color may be affected at temperatures above its operational range.
6. Keep the temperature within the specified range usage and storage. Excessive temperature
7. and humidity could cause polarization degradation, polarizer peel-off or generate bubbles.
8. For long-term storage over 40°C is required, the relative humidity should be kept below 60%,
9. and avoid direct sunlight.

11.5 Limited Warranty

XINPENG LCDs and modules are not consumer products, but may be incorporated by XINPENG's customers into consumer products or components thereof, XINPENG does not warrant that its LCDs and components are fit for any such particular purpose.

1. The liability of XINPENG is limited to repair or replacement on the terms set forth below. XINPENG will not be responsible for any subsequent or consequential events or injury or damage to any personnel or user including third party personnel and/or user. Unless otherwise agreed in writing between XINPENG and the customer, XINPENG will only replace or repair any of its LCD which is found defective electrically or visually when inspected in accordance with XINPENG general LCD inspection standard. (Copies available on request)



2. No warranty can be granted if any of the precautions state in handling liquid crystal display above has been disregarded. Broken glass, scratches on polarizer mechanical damages as well as defects that are caused accelerated environment tests are excluded from warranty.
3. In returning the LCD/LCM, they must be properly packaged; there should be detailed description of the failures or defect.